



# Filler Metals Bestseller for Joining Applications

### **Böhler Welding Lasting Connections**

Böhler Welding, a merger of the product brands „Böhler“, „T-PUT“, „Avesta“ and „UTP“ in the brand network of voestalpine Böhler Welding, is renown for over 85 years as an innovative producer of welding consumables for joint welding in all major arc welding processes. Böhler Welding has a leading position globally with especial regards from medium- up to high-alloyed grades, where we continuously set our focus.

Böhler Welding offers a globally unique and complete product portfolio of welding consumables from own production. The extensive range of approximately 2.000 products is constantly aligned to the up-to-date specifications of the most demanding industries and is adjusted, if necessary, to the market requirements under observance of the highest quality standards.

The product brands comprising Böhler Welding look back at a longstanding and proven international market history and are in their respective specialized areas permanently on the leading edge of innovation. The merger into „Böhler Welding“ bundles the metallurgical, service and technical know-how we have accumulated globally over decades for the maximum benefit of our customers and partners.

Our maxim „lasting connections“ is basis of our actions. On one hand this reflected in our high quality products, services and solutions, which are being applied successfully globally, but even more so in the lasting relationships we have built with customers and partners globally.

With our international network of 34 sales companies, 11 production units, as well as distribution partners in over 150 countries around the globe, we are always in close proximity to our customers and can offer our support for daily operational welding challenges. Our experienced welding engineers go, if necessary, into the deepest details of welding technology and are only satisfied once the optimum and most economical solution is found for the customer. This customer focus is also manifested in our research and development activities, which are clearly driven at Böhler Welding by specific industry- or customer-requirements. Cooperations with leading companies of various industries, universities and research institutes, as well as our parent company voestalpine of course, ensure that we continuously push the edge of innovation and this will allow us to guarantee the already expected lasting connections of highest quality well into the future.

## Chapter - Overview

I - General Information

II - General notes

1.1 - Stick electrodes (unalloyed, low-alloyed)

1.2 - Stick electrodes (high-alloyed)

2.1 - TIG rod (unalloyed, low-alloyed)

2.2 - TIG rod (high-alloyed)

3.1 - (GMAW) Solid wire (unalloyed, low-alloyed)

3.2 - (GMAW) Solid wire (high-alloyed)

4.1 - SAW Wire (low-alloyed, unalloyed)

4.2 - SAW Wire (high-alloyed)

4.3 - SAW Flux

5.1 - Flux cored wire (unalloyed, low-alloyed)

5.2 - Flux cored wire (high-alloyed)

6.1 - Finishing Chemicals

7.0 - Procedure-oriented selection

8.0 - Materials-oriented selection

10.0 - Economic considerations

## Chapter 1.1 - Stick electrodes (unalloyed, low-alloyed)

Product Name	EN/ISO-Standard	EN/ISO-Classification	AWS-Classification	Chapter Page
BÖHLER FOX KE	EN ISO 2560-A	E 38 0 RC 11	E6013	2
BÖHLER FOX OHV	EN ISO 2560-A	E 38 0 RC 11	E6013	3
Phoenix SH Gelb R	EN ISO 2560-A	E 38 2 RB 12	E6013	4
Phoenix Blau	EN ISO 2560-A	E 42 0 RC 11	E6013	5
BÖHLER FOX ETI	EN ISO 2560-A	E 42 0 RR 12	E6013	6
Phoenix Grün T	EN ISO 2560-A	E 42 0 RR 12	E6013	7
BÖHLER FOX EV 47	EN ISO 2560-A	E 38 4 B 42 H5	E7016-1H4R	8
BÖHLER FOX EV 50-A	EN ISO 2560-A	E 42 3 B 12 H10	E7016	9
Phoenix SPEZIAL D	EN ISO 2560-A	E 42 3 B 12 H10	E 7016	10
UTP COMET J 50 N	EN ISO 2560-A	E 42 3 B 12 H 10	E 7016	11
BÖHLER FOX EV 50	EN ISO 2560-A	E 42 5 B 42 H5	E7018-1H4R	12
Phoenix 120 K	EN ISO 2560-A	E 42 5 B 32 H5	E7018-1	13
BÖHLER FOX CEL	EN ISO 2560-A	E 38 3 C 21	E6010	14
BÖHLER FOX CEL+	EN ISO 2560-A	E 38 2 C 21	E6010	15
Phoenix Cel 70	EN ISO 2560-A	E 42 2 C 25	E6010	16
Phoenix Cel 75	EN ISO 2560-A	E 42 2 C 25	E7010-P1	17
BÖHLER FOX CEL 75	EN ISO 2560-A	E 42 3 C 25	E7010-P1	18
BÖHLER FOX CEL Mo	EN ISO 2560-A	E 42 3 Mo C 25	E7010-A1	19
Phoenix Cel 80	EN ISO 2560-A	E 46 3 C 25	E8010-P1	20
BÖHLER FOX CEL 85	EN ISO 2560-A	E 46 4 1Ni C 25	E8010-P1	21
BÖHLER FOX CEL 90	EN ISO 2560-A	E 50 3 1Ni C 25	E9010-P1	22
Phoenix Cel 90	EN ISO 2560-A	E 50 3 1Ni C 25	E9010-G	23
BÖHLER FOX EV PIPE	EN ISO 2560-A	E 42 4 B 12 H5	E7016-1H4R	24
BÖHLER FOX BVD 85	EN ISO 2560-A	E 46 5 1Ni B 45	E8045-P2	25
BÖHLER FOX BVD 90	EN ISO 18275	E 55 5 Z2Ni B 45	E9045-P2 (mod.)	26
BÖHLER FOX BVD 100	EN ISO 18275	E 62 5 Z2Ni B 45	E10045-P2 (mod.)	27
BÖHLER FOX EV 60	EN ISO 2560-A	E 46 6 1Ni B 42 H5	E8018-C3H4R	28
Phoenix SH Schwarz 3 K	EN ISO 2560-A	E 50 4 Mo B 42	E7015-G	29
Phoenix SH Schwarz 3 K Ni	EN ISO 2560-A	E 50 4 1NiMo B 42 H5	E9018-G	30
BÖHLER FOX EV 65	EN ISO 18275	E 55 6 1NiMo B 42 H5	E8018-GH4R	31
Phoenix SH Ni 2 K 100	EN ISO 18275-A	E 69 5 Mn2NiCrMo B 42 H5	E11018-G	32
BÖHLER FOX EV 85	EN ISO 18275	E 69 6 Mn2NiCrMo B 42 H5	E11018-GH4R	33
BÖHLER FOX DMO Kb	EN ISO 3580-A	E Mo B 4 2 H5	E7018-A1H4R	34
Phoenix SH Schwarz 3 MK	EN ISO 3580-A	E Mo B 42 H5	E7018-A1	35
BÖHLER FOX DCMS Kb	EN ISO 3580-A	E CrMo1 B 4 2 H5	E8018-B2H4R	36
Phoenix Chromo 1	EN ISO 3580-A	E CrMo 1 B 42 H5	E8018-B2	37
Phoenix SH Chromo 2 KS	EN ISO 3580-A	E CrMo 2 B 42 H5	E9015-B3	38
Phoenix SH Kupfer 3 KC	EN ISO 3580-A	E ZCrMoV 1 B 42 H5	E9015-G	39
BÖHLER FOX C 9 MV	EN ISO 3580-A	E CrMo91 B 4 2 H5	E9015-B9	40
BÖHLER FOX P 92	EN ISO 3580-A	E ZCrMoWVnb 9 0,5 2 B 4 2 H5	E9015-B9 (mod.)	41
Thermanit MTS 616	EN ISO 3580-A	E ZCrMoWVnb 9 0,5 2 B 4 2 H5	E9015-G	42
Thermanit Chromo 9 V	EN ISO 3580-A	E CrMo 91 B 42 H5	E9015-B9	43
Thermanit MTS 3	EN ISO 3580-A	E CrMo 91 B 42 H5	E9015-B9	44
BÖHLER FOX CM 2 Kb	EN ISO 3580-A	E CrMo2 B 4 2 H5	E9018-B3H4R	45
BÖHLER FOX CM 5 Kb	EN ISO 3580-A	E CrMo5 B 4 2 H5	E8018-B6H4R	46
BÖHLER FOX CM 9 Kb	EN ISO 3580-A	E CrMo9 B 4 2 H5	E8018-B8	47
BÖHLER FOX 20 M/W	EN ISO 3580-A	E CrMoWV 12 B 4 2 H5	-	48
Avesta 308/308H AC/DC	EN ISO 3581	E 19 9 R	E308H-17	49
BÖHLER FOX E 308 H	EN ISO 3581	E 19 9 H R 4 2	E308H-16	50
Thermanit ATS 4	EN 1600	E 19 9 H B 22	E308H-15	51
BÖHLER FOX 2,5 Ni	EN ISO 2560-A	E 46 8 2Ni B 42 H5	E8018-C1H4R	52

## Chapter 1.2 - Stick electrodes (high-alloyed)

Product Name	EN/ISO-Standard	EN/ISO-Classification	AWS-Classification	Chapter Page
BÖHLER FOX EAS 2	EN ISO 3581	E 19 9 L B 2 2	E308L-15	4
Avesta 308L/MVR	EN ISO 3581	E 19 9 L R	E308L-17	5
BÖHLER FOX EAS 2-A	EN ISO 3581	E 19 9 L R 3 2	E308L-17	6
Thermanit JEW 308L-17	EN ISO 3581	E 19 9 L R 3 2	E308L-17	7
Avesta 309L	EN ISO 3581	E 23 12 L R	E309L-17	8
BÖHLER FOX CN 23/12-A	EN ISO 3581	E 23 12 L R 3 2	E309L-17	9
BÖHLER FOX EAS 4 M	EN ISO 3581	E 19 12 3 L B 2 2	E316L-15	10
Avesta 316L/SKR Cryo	EN ISO 3581	E 19 12 3 L R	E316L-16	11
Avesta 316L/SKR	EN ISO 3581	E 19 12 3 L R	E316L-17	12
Avesta 316L/SKR-2D	EN ISO 3581	E 19 12 3 L R	E316L-17	13
Avesta 316L/SKR-4D	EN ISO 3581	E 19 12 3 L R	E316L-17	14
Avesta 316L/SKR-PW AC/DC	EN ISO 3581	E 19 12 3 L R	E316L-17	15
BÖHLER FOX EAS 4 M-A	EN ISO 3581	E 19 12 3 L R 3 2	E316L-17	16
Thermanit GEW 316L-17	EN ISO 3581	E 19 12 3 L R 3 2	E316L-17	17
BÖHLER FOX SAS 4	EN ISO 3581	E 19 12 3 Nb B 2 2	E318-15	18
BÖHLER FOX SAS 4-A	EN ISO 3581	E 19 12 3 Nb R 3 2	E318-17	19
Thermanit AW	EN ISO 3581	E 19 12 3 Nb R 3 2	E318-17	20
Avesta 347/MVNB	EN ISO 3581	E 19 9 Nb R	E347-17	21
BÖHLER FOX SAS 2	EN ISO 3581	E 19 9 Nb B 2 2	E347-15	22
BÖHLER FOX SAS 2-A	EN ISO 3581	E 19 9 Nb R 3 2	E347-17	23
BÖHLER FOX CN 13/4	EN ISO 3581	E 13 4 B 6 2	E410NiMo-15	24
BÖHLER FOX A 7	EN ISO 3581	E 18 8 Mn B 2 2	E307-15 (mod.)	25
Thermanit X	EN ISO 3581	E 18 8 Mn B 2 2	E307-15 (mod.)	26
BÖHLER FOX A 7-A	EN ISO 3581	E Z18 9 MnMo R 3 2	E307-16 (mod.)	27
Thermanit XW	EN ISO 3581	E 18 8 Mn R 1 2	E307-16 (mod.)	28
BÖHLER FOX CN 19/9 M	EN ISO 3581	E 20 10 R 3 2	E308Mo-17 (mod.)	29
Avesta 904L	EN ISO 3581	E 20 25 5 Cu N L R	E385-17	30
BÖHLER FOX CN 20/25 M-A	EN ISO 3581	E 20 25 5 Cu N L R 3 2	E385-17 (mod.)	31
Avesta 253 MA	EN ISO 3581	E 21 10 R	-	32
UTP 2133 Mn	EN ISO 3581	E Z 2133 B 42	-	33
Avesta 2205 basic	EN ISO 3581	E 22 9 3 N L B	E2209-15	34
Avesta 2205	EN ISO 3581	E 22 9 3 N L R	E2209-17	35
Avesta 2205-PW AC/DC	EN ISO 3581	E 22 9 3 N L R	E2209-17	36
BÖHLER FOX CN 22/9 N	EN ISO 3581	E 22 9 3 N L R 3 2	E2209-17	37
Avesta 2304	EN ISO 3581	E 23 7 N L R	-	38
Avesta LDX 2101	EN ISO 3581	E 23 7 N L R	-	39
Avesta P5	EN ISO 3581	E 23 12 2 L R	E309MoL-17	40
BÖHLER FOX CN 23/12 Mo-A	EN ISO 3581	E 23 12 2 L R 3 2	E309LMo-17	41
BÖHLER FOX FFB	EN ISO 3581	E 25 20 B 2 2	E310-15 (mod.)	42
BÖHLER FOX FFB-A	EN ISO 3581	E 25 20 R 3 2	E310-16	43
Avesta 310	EN ISO 3581	E 25 20 R	E310-17	44
Avesta 2507/P100 RUTILE	EN ISO 3581	E 25 9 4 N L R	E2594-16	45
Thermanit 25/09 CuT	EN ISO 3581	E 25 9 4 N L B 2 2	E2553-15 (mod.)	46
Thermanit 25/22 H	EN ISO 3581	E Z25 22 2 L B 2 2	-	47
Avesta P7 AC/DC	EN ISO 3581	E 29 9 R	-	48
UTP 65 D	EN ISO 3581	E 29 9 R 12	-	49
Thermanit 30/10 W	EN 1600	E 29 9 R 12	E312-16 mod.	50
BÖHLER FOX CN 29/9-A	EN ISO 3581	E 29 9 R 3 2	E312-17	51
UTP 65	EN ISO 3581	E 29 9 R 3 2	-	52
Avesta 317L/SNR	-	-	E317L-17	53
UTP 2535 Nb	EN ISO 3581	E Z 25 35 Nb B62	-	54
BÖHLER FOX NIBAS 625	EN ISO 14172	E Ni 6625 (NiCr22Mo9Nb)	ENiCrMo-3	55

## Chapter 1.2 - Stick electrodes (high-alloyed)

Thermanit 625	EN ISO 14172	E Ni 6625 (NiCr22Mo9Nb)	E NiCrMo-3	56
UTP 6222 Mo	EN ISO 14172	E Ni 6625 (NiCr22Mo9Nb)	E NiCrMo-3	57
BÖHLER FOX NIBAS 70/20	EN ISO 14172	E Ni 6082 (NiCr20Mn3Nb)	ENiCrFe-3 (mod.)	58
Thermanit Nicro 82	EN ISO 14172	E Ni 6082 (NiCr20Mn3Nb)	ENiCrFe-3 (mod.)	59
UTP 068 HH	EN ISO 14172	E Ni 6082 (NiCr20Mn3Nb)	E NiCrFe-3 (mod.)	60
UTP 6170 CO	EN ISO 14172	E Ni 6117 (NiCr22Co12Mo)	~E NiCrCoMo-1	61
Thermanit Nicro 182	EN ISO 14172	E Ni 6182 (NiCr15Fe6Mn)	ENiCrFe-3	62
UTP 759 Kb	EN ISO 14172	E Ni 6059 (NiCr23Mo16)	ENiCrMo-13	63
Thermanit NiMo C 24	EN ISO 14172	E Ni 6059 (NiCr23Mo16)	ENiCrMo-13	64
UTP 7015	EN ISO 14172	E Ni 6182 (NiCr15Fe6Mn)	E Ni Cr Fe-3	65
UTP 7015 Mo	EN ISO 14172	E Ni 6093(NiCr15Fe8NbMo)	E Ni Cr Fe-2	66
UTP 7013 Mo	EN ISO 14172	E Ni 6620 (NiCr14Mo7Fe)	E NiCrMo-6	67
UTP 80 M	EN ISO 14172	E Ni 4060 (NiCu30Mn3Ti)	ENiCu-7	68
Avesta P12-R basic	EN ISO 3581	E Ni Cr 22 Mo 9	ERNiCrMo-12	69

## Chapter 2.1 - TIG rod (unalloyed, low-alloyed)

Product Name	EN/ISO-Standard	EN/ISO-Classification	AWS-Classification	Chapter Page
BÖHLER EMK 6	EN ISO 636-A	W 42 5 W3Si1	ER70S-6	2
BÖHLER EML 5	EN ISO 636-A	W 46 5 W2Si	ER70S-3	3
Union I 52	EN ISO 636-A	W 42 5 W3Si1	ER70S-6	4
BÖHLER DMO-IG	EN ISO 636-A	W MoSi	ER70S-A1	5
BÖHLER DCMS-IG	EN ISO 21952-A	W CrMo1Si	ER80S-B2 (mod.)	6
Union I Mo	EN ISO 636-A	W 46 3 W2Mo	ER80S-G(A1)	7
Union I CrMo	EN ISO 21952-A	W CrMo1Si	ER80S-G	8
BÖHLER CM 2-IG	EN ISO 21952-A	W CrMo2Si	ER90S-B3 (mod.)	9
BÖHLER C 9 MV-IG	EN ISO 21952-A	W CrMo91	ER90S-B9	10
Thermanit MTS 3	EN ISO 21952-A	W CrMo91	ER90S-B9	11
Union I CrMo 910	EN ISO 21952-A	W CrMo2Si	ER90S-G	12
Union I P24	EN ISO 21952-A	W Z CrMo2VTi/Nb	ER90S-G	13
Thermanit MTS 616	EN ISO 21952-A	W Z CrMoWVNb 9 0,5 1,5	ER90S-G [ER90S-B9(-mod.)]	14
Thermanit ATS 4	EN ISO 14343-A	W 19 9 H	ER19-10H	15
BÖHLER DMO	EN 12536	O IV	R60-G	16
BÖHLER Ni 1-IG	EN ISO 636-A	W3Ni1	ER80S-Ni1 (mod.)	17
BÖHLER 2,5 Ni-IG	EN ISO 636-A	W 46 8 W2Ni2	ER80S-Ni2	18

## Chapter 2.2 - TIG rod (high-alloyed)

BÖHLER A 7 CN-IG	EN ISO 14343-A	W 18 8 Mn	ER307 (mod.)	2
Thermanit X	EN ISO 14343-A	W 18 8 Mn	ER307 (mod.)	3
Avesta 308L/MVR	EN ISO 14343-A	W 19 9 L	ER308L	4
Avesta 308L-Si/MVR-Si	EN ISO 14343-A	W 19 9 L Si	ER308LSi	5
Thermanit JE-308L	EN ISO 14343-A	W 19 9 L	ER308L	6
Thermanit JE-308L Si	EN ISO 14343-A	W 19 9 L Si	ER308LSi	7
BÖHLER CN 23/12-IG	EN ISO 14343-A	W 23 12 L	ER309L	8
Thermanit 25/14 E-309L	EN ISO 14343-A	W 23 12 L	ER309L	9
Avesta 309L-Si	EN ISO 14343-A	W 23 12 L Si	ER309LSi	10
Thermanit D	EN ISO 14343-A	W 22 12 H	ER309 (mod.)	11
BÖHLER FF-IG	EN ISO 14343-A	W 22 12 H	ER309 (mod.)	12
Avesta 316L/SKR	EN ISO 14343-A	W 19 12 3 L	ER316L	13
Avesta 316L-Si/SKR-Si	EN ISO 14343-A	W 19 12 3 L Si	ER316LSi	14
BÖHLER EAS 4 M-IG	EN ISO 14343-A	W 19 12 3 L	ER316L	15
Thermanit GE-316L	EN ISO 14343-A	W 19 12 3 L	ER316L	16
Thermanit GE-316L Si	EN ISO 14343-A	W 19 12 3 L Si	ER316LSi	17
BÖHLER SAS 4-IG	EN ISO 14343-A	W 19 12 3 Nb	ER318	18
Thermanit A	EN ISO 14343-A	W 19 12 3 Nb	ER318	19
Avesta 318-Si/SKNb-Si	EN ISO 14343-A	W 19 12 3 Nb Si	ER318(mod.)	20

## Chapter 2.2 - TIG rod (high-alloyed) *cont.*

BÖHLER SAS 2-IG	EN ISO 14343-A	W 19 9 Nb	ER347	21
Thermanit H-347	EN ISO 14343-A	W 19 9 Nb	ER347	22
BÖHLER CN 13/4-IG	EN ISO 14343-A	W 13 4	ER410NiMo (mod.)	23
Avesta 2205	EN ISO 14343-A	W 22 9 3 N L	ER2209	24
BÖHLER CN 22/9 N-IG	EN ISO 14343-A	W 22 9 3 N L	ER2209	25
Thermanit 22/09	EN ISO 14343-A	W 22 9 3 N L	ER2209	26
Avesta LDX 2101	EN ISO 14343-A	W 23 7 N L	-	27
Avesta P5	EN ISO 14343-A	W 23 12 2 L	ER309LMo(mod.)	28
Avesta 2507/P100	EN ISO 14343-A	W 25 9 4 N L	ER2594	29
BÖHLER CN 25/9 CuT-IG	EN ISO 14343-A	W 25 9 4 N L	ER2594	30
Thermanit 25/09 CuT	EN ISO 14343-A	W 25 9 4 N L	ER2594	31
Thermanit L	EN ISO 14343-A	W 25 4	-	32
BÖHLER FA-IG	EN ISO 14343-A	W 25 4	-	33
BÖHLER FFB-IG	EN ISO 14343-A	W 25 20 Mn	ER310 (mod.)	34
UTP A 2133 Mn	EN ISO 14343-A	W Z 21 33 Mn Nb	-	35
UTP A 2535 Nb	EN ISO 14343-A	W Z 25 35 Zr	-	36
UTP A 3545 Nb	EN ISO 14343-A	W Z 35 45 Nb	-	37
Thermanit 35/45 Nb	EN ISO 18274	S Ni Z (NiCr36Fe15Nb0,8)	-	38
Avesta P12	EN ISO 18274	S Ni 6625 (NiCr22Mo9Nb)	ERNiCrMo-3	39
BÖHLER NIBAS 625-IG	EN ISO 18274	S Ni 6625 (NiCr22Mo9Nb)	ERNiCrMo-3	40
Thermanit 625	EN ISO 18274	S Ni 6625 (NiCr22Mo9Nb)	ERNiCrMo-3	41
UTP A 6222 Mo	EN ISO 18274	S Ni 6625 (NiCr22Mo9Nb)	ER NiCrMo-3	42
BÖHLER NIBAS 70/20-IG	EN ISO 18274	S Ni 6082 (NiCr20Mn3Nb)	ERNiCr-3	43
Thermanit Nicro 82	EN ISO 18274	S Ni 6082 (NiCr20Mn3Nb)	ERNiCr-3	44
UTP A 068 HH	EN ISO 18274	S Ni 6082 (NiCr20Mn3Nb)	ERNiCr-3	45
Thermanit 617	EN ISO 18274	S Ni 6617 (NiCr22Co12Mo9)	ERNiCrCoMo-1	46
UTP A 6170 Co	EN ISO 18274	S Ni 6617 (NiCr22Co12Mo9)	ERNiCrCoMo-1	47
UTP A 776	EN ISO 18274	S Ni 6276 (NiCr15Mo16FeW4)	ERNiCrMo-4	48
Thermanit NiMo C 24	EN ISO 18274	S Ni 6059 (NiCr23Mo16)	ERNiCrMo-13	49
UTP A 759	EN ISO 18274	S Ni 6059 (NiCr23Mo16)	ER NiCrMo-13	50
UTP A 80 M	EN ISO 18274	S Ni 4060 (NiCu30Mn3Ti)	ERNiCu-7	51

6

## Chapter 3.1 - (GMAW) Solid wire (unalloyed, low-alloyed)

Product Name	EN/ISO-Standard	EN/ISO-Classification	AWS-Classification	Chapter Page
BÖHLER EMK 6	EN ISO 14341-A	G 42 4 M21 3Si1 / G 42 4 C1 3Si1	ER70S-6	2
Union K 52	EN ISO 14341-A	G 42 2 C1 3Si1 / G 46 4 M21 3Si1	ER70S-6	3
BÖHLER EMK 8	EN ISO 14341-A	G 46 4 M21 4Si1 / G 46 4 C1 4Si1	ER70S-6	4
Union K 56	EN ISO 14341-A	G 46 2 C G4Si1 / G 46 4 M G4Si1	ER70S-6	5
BÖHLER NICU 1-IG	EN ISO 14341-A	G 42 4 M21 Z3Ni1Cu / G 42 4 C1 Z3Ni1Cu	ER80S-G	6
BÖHLER NiMo 1-IG	EN ISO 16834-A	G 55 6 M21 Mn3Ni1Mo / G 55 4 C1 Mn3Ni1Mo	ER90S-G	7
Union MoNi	EN ISO 16834-A	G 62 5 M21 Mn3Ni1Mo	ER90S-G	8
Union NiMoCr	EN ISO 16834-A	G 69 6 M21 Mn4Ni1,5CrMo	ER100S-G	9
BÖHLER NiCrMo 2,5-IG	EN ISO 16834-A	G 69 6 M21 Mn3Ni2,5CrMo / G 69 4 C1 Mn3Ni2,5CrMo	ER110S-G	10
BÖHLER X 70-IG	EN ISO 16834-A	G 69 5 M21 Mn3Ni1CrMo	ER110S-G	11
Union X 85	EN ISO 16834-A	G 79 5 M21 Mn4Ni1,5CrMo	ER110S-G	12
BÖHLER X 90-IG	EN ISO 16834-A	G 89 6 M21 Mn4Ni2CrMo	ER120S-G	13
Union X 90	EN ISO 16834-A	G 89 6 M21 Mn4Ni2CrMo	ER120S-G	14
Union X 96	EN ISO 16834-A	G 89 5 M21 Mn4Ni2,5CrMo	ER120S-G	15
BÖHLER DMO-IG	EN ISO 21952-A	G MoSi	ER70S-A1	16
Union I Mo	EN ISO 21952-A	G MoSi	ER80S-G(A1)	17
BÖHLER DCMS-IG	EN ISO 21952-A	G CrMo1Si	ER80S-G [ER80S-B2 (mod.)]	18
Union I CrMo	EN ISO 21952-A	G CrMo1Si	ER80S-G [ER80S-B2 (mod.)]	19

## Chapter 3.1 - (GMAW) Solid wire (unalloyed, low-alloyed)

BÖHLER CM 2-IG	EN ISO 21952-A	G CrMo2Si	ER90S-B3 (mod.)	20
BÖHLER C 9 MV-IG	EN ISO 21952-A	G CrMo91	ER90S-B9	21
Thermanit MTS 3	EN ISO 21952-A	G CrMo91	ER90S-B9	22
Union I CrMo 910	EN ISO 21952-A	G CrMo2Si	ER90S-G	23
Thermanit MTS 616	EN ISO 21952-A	GZ CrMoWVNB 9 0.5 1.5	ER90S-G [ER90S-B9(mod.))]	24
Thermanit ATS 4	EN ISO 14343-A	G 19 9 H	ER19-10H	25
Union K 5 Ni	EN ISO 14341-A	G 50 5 M21 3Ni1/G 46 3 C1 3Ni1	ER80S-G	26
BÖHLER SG 8-P	EN ISO 14341-A	G 42 5 M21 3Ni1	ER80S-G	27
BÖHLER 2,5 Ni-IG	EN ISO 14341-A	G 46 8 M21 2Ni2	ER80S-Ni2	28
Union K 52 Ni	EN ISO 14341-A	G 50 6 M21 2Ni2/G 46 4 C1 2Ni2	ER80S-G [ER80S-Ni1(-mod.))]	29
Union K NOVA Ni	EN ISO 14341-A	G 42 5 M21 3Ni1	ER80S-G [ER80S-Ni1(-mod.))]	30
Union Ni 2,5	EN ISO 14341-A	G 50 7 M21 2Ni2	ER80S-Ni2	31

## Chapter 3.2 - (GMAW) Solid wire (high-alloyed)

Product Name	EN/ISO-Standard	EN/ISO-Classification	AWS-Classification	Chapter Page
Avesta 307-Si	EN ISO 14343-A	G 18 8 Mn	ER307 (mod.)	2
BÖHLER A 7-IG / A 7 CN-IG	EN ISO 14343-A	G 18 8 Mn	ER307 (mod.)	3
Thermanit X	EN ISO 14343-A	G 18 8 Mn	ER307 (mod.)	4
Avesta 308L-Si/MV-Si	EN ISO 14343-A	G 19 9 L Si	ER308LSi	5
BÖHLER EAS 2-IG (Si)	EN ISO 14343-A	G 19 9 L Si	ER308LSi	6
Thermanit JE-308L Si	EN ISO 14343-A	G 19 9 L Si	ER308LSi	7
Avesta 309L-Si	EN ISO 14343-A	G 23 12 L Si	ER309LSi	8
BÖHLER CN 23/12-IG	EN ISO 14343-A	G 23 12 L	ER309L	9
Thermanit 25/14 E-309L Si	EN ISO 14343-A	G 23 12 L Si	ER309LSi	10
BÖHLER FF-IG	EN ISO 14343-A	G 22 12 H	ER309 (mod.)	11
Thermanit D	EN ISO 14343-A	G 22 12 H	ER309 (mod.)	12
Avesta 316L-Si/SKR-Si	EN ISO 14343-A	G 19 12 3 L Si	ER316LSi	13
BÖHLER EAS 4 M-IG (Si)	EN ISO 14343-A	G 19 12 3 L Si	ER316LSi	14
Thermanit GE-316L Si	EN ISO 14343-A	G 19 12 3 L Si	ER316LSi	15
Avesta 318-Si/SK/Nb-Si	EN ISO 14343-A	G 19 12 3 Nb Si	-	16
BÖHLER ASN 5-IG (Si)	EN ISO 14343-A	G Z18 16 5 N L	ER317L (mod.)	17
Thermanit A Si	EN ISO 14343-A	G 19 12 3 Nb Si	ER318 (mod.)	18
BÖHLER SAS 2-IG (Si)	EN ISO 14343-A	G 19 9 Nb Si	ER347Si	19
Thermanit H Si	EN ISO 14343-A	G 19 9 Nb Si	ER347Si	20
BÖHLER CN 13/4-IG	EN ISO 14343-A	G 13 4	ER410NiMo (mod.)	21
Avesta 2205	EN ISO 14343-A	G 22 9 3 N L	ER2209	22
BÖHLER CN 22/9 N-IG	EN ISO 14343-A	G 22 9 3 N L	ER2209	23
Thermanit 22/09	EN ISO 14343-A	G 22 9 3 N L	ER2209	24
Avesta LDX 2101	EN ISO 14343-A	G 23 7 N L	-	25
Avesta P5	EN ISO 14343-A	G 23 12 2 L	-	26
Avesta 2507/P100	EN ISO 14343-A	G 25 9 4 N L	-	27
Thermanit 25/09 CuT	EN ISO 14343-A	G 25 9 4 N L	ER2594	28
BÖHLER FA-IG	EN ISO 14343-A	G 25 4	-	29
Thermanit L	EN ISO 14343-A	G 25 4	-	30
BÖHLER FFB-IG	EN ISO 14343-A	G 25 20 Mn	ER310 (mod.)	31
BÖHLER SKWAM-IG	EN ISO 14343-A	G Z 17 Mo	-	32
Thermanit 17/15 TT	EN ISO 14343-A	G Z 17 15 Mn W	-	33
BÖHLER CAT 430L Cb-IG	EN ISO 14343-A	G Z 18 L Nb	ER430 (mod.)	34
BÖHLER CAT 430L CbTi-IG	EN ISO 14343-A	G Z Cr 18 NbTi L	ER430Nb (mod.)	35
Thermanit 439 Ti	EN ISO 14343-A	G Z 18 Ti L	ER439 (mod.)	36
UTP A 2133 Mn	EN ISO 14343-A	G Z 21 33 Mn Nb	-	37
UTP A 2535 Nb	EN ISO 14343-A	G Z 25 35 Zr	-	38
Avesta P12	EN ISO 18274	S Ni 6625 (NiCr22Mo9Nb)	ERNiCrMo-3	39
BÖHLER NIBAS 625-IG	EN ISO 18274	S Ni 6625 (NiCr22Mo9Nb)	ERNiCrMo-3	40



## Chapter 3.2 - (GMAW) Solid wire (high-alloyed) cont.

Thermanit 625	EN ISO 18274	S Ni 6625 (NiCr22Mo9Nb)	ERNiCrMo-3	41
UTP A 6222 Mo	EN ISO 18274	S Ni 6625 (NiCr22Mo9Nb)	ERNiCrMo-3	42
BÖHLER NIBAS 70/20-IG	EN ISO 18274	S Ni 6082 (NiCr20Mn3Nb)	ERNiCr-3	43
Thermanit Nicro 82	EN ISO 18274	S Ni 6082 (NiCr20Mn3Nb)	ERNiCr-3	44
UTP A 068 HH	EN ISO 18274	S Ni 6082 (NiCr20Mn3Nb)	ERNiCr-3	45
Thermanit 617	EN ISO 18274	S Ni 6617 (NiCr22Co12Mo9)	ERNiCrCoMo-1	46
UTP A 6170 Co	EN ISO 18274	S Ni 6617 (NiCr22Co12Mo9)	ERNiCrCoMo-1	47
UTP A 776	EN ISO 18274	S Ni 6276 (NiCr15Mo16Fe6W4)	ERNiCrMo-4	48
Thermanit NiMo C 24	EN ISO 18274	S Ni 6059 (NiCr23Mo16)	ERNiCrMo-13	49
UTP A 759	EN ISO 18274	S Ni 6059 (NiCr23Mo16)	ER NiCrMo-13	50
UTP A 80 M	EN ISO 18274	S Ni 4060 (NiCu30Mn3Ti)	ERNiCu-7	51
Thermanit 35/45 Nb	EN ISO 18274	S Ni Z (NiCr36Fe15Nb0,8)	-	52
UTP A 3545 Nb	EN ISO 14343-A	G Z 35 45 Nb	-	53

## Chapter 4.1 - SAW Wire (low-alloyed, unalloyed)

Product Name	EN/ISO-Standard	EN/ISO-Classification	AWS-Classification	Chapter Page
BÖHLER EMS 2 + BB 24	EN ISO 14171-A	S 38 6 FB S2	F7A8-EM12K (F6P6-EM12K)	2
Union S 2	EN ISO 14171-A	S2	EM12	3
Union S 2 Si	EN ISO 14171-A	S2Si	EM12K	4
Union S 3	EN ISO 14171-A	S3	EH10K	5
Union S 3 Si	EN ISO 14171-A	S3Si	EH12K	6
BÖHLER EMS 2 Mo + BB 24	EN ISO 14171-A	S 46 4 FB S2Mo	F8A4-EA2-A2/ F8P0-EA2-A2	7
Union S 2 Mo	EN ISO 24598-A	S2Mo	EA2	8
Union S 3 Mo	EN ISO 24598-A	S3Mo	EA4	9
Union S 2 NiMo 1	EN ISO 14171-A	SZ2Ni1Mo	ENi1	10
BÖHLER 3 NiMo 1-UP + BB 24	EN ISO 26304-A	S 55 4 FB S3Ni1Mo	F9A4-EF3-F3	11
Union S 3 NiMo 1	EN ISO 14171-A	S3Ni1Mo	EF3	12
Union S 3 NiMo	EN ISO 14171-A	S3Ni1,5Mo	EG [EF1 (mod.)]	13
Union S 3 NiMoCr	EN ISO 26304-A	SZ3Ni2,5CrMo	EG [EF6 (mod.)]	14
BÖHLER 3 NiCrMo 2,5-UP + BB 24	EN ISO 26304-A	S 69 6 FB S3Ni2,5CrMo	F11A8-EM4 (mod.)- M4H4	15
BÖHLER EMS 2 CrMo + BB 24	EN ISO 24598-A	S S CrMo1 FB	F8P2-EB2-B2	16
Union S 2 CrMo	EN ISO 24598-A	S CrMo1	EB2R	17
Union S 1 CrMo 2	EN ISO 24598-A	S CrMo2	EB3R	18
BÖHLER CM 2-UP + BB 418 TT	EN ISO 24598-A	S S CrMo2 FB	F8P2-EB3-B3	19
BÖHLER C 9 MV-UP + BB 910	EN ISO 24598-A	S S CrMo91 FB	EB9	20
Thermanit MTS 3	EN ISO 24598-A	S CrMo91	EB9	21
Union S P 24	EN ISO 24598-A	S Z CrMo2VNb	EG	22
Union S 1 CrMo 2 V	EN ISO 24598-A	S ZCrMoV2	EG	23
Thermanit MTS 616	EN ISO 24598-A	S ZCrMoWVNb 9 0,5 1,5	EG [EB9(mod.)]	24
BÖHLER Ni 2-UP + BB 24	EN ISO 14171-A	S 46 6 FB S2Ni2	F8A8-ENi2-Ni2	25
Union S 2 Ni 2,5	EN ISO 14171-A	S2Ni2	ENi2	26
Union S 2 Ni 3,5	EN ISO 14171-A	S2Ni3	ENi3	27

## Chapter 4.2 - SAW Wire (high-alloyed)

Product Name	EN/ISO-Standard	EN/ISO-Classification	AWS-Classification	Chapter Page
BÖHLER A 7 CN-UP + BB 203	EN ISO 14343-A	S 18 8 Mn	ER307 (mod.)	2
Thermanit X	EN ISO 14343-A	S 18 8 Mn	ER307(mod.)	3
Avesta 308L/MVR	EN ISO 14343-A	S 19 9 L	ER308L	4
Thermanit JE-308L	EN ISO 14343-A	S 19 9 L	ER308L	5
Avesta 309L	EN ISO 14343-A	S 23 12 L	ER309L	6
Thermanit 25/14 E-309L	EN ISO 14343-A	S 23 12 L	ER309L	7
Avesta 316L/SKR	EN ISO 14343-A	S 19 12 3 L	ER316L	8
BÖHLER EAS 4 M-UP + BB 202	EN ISO 14343-A	S 19 12 3 L	ER316L	9
Thermanit GE-316L	EN ISO 14343-A	S 19 12 3 L	ER316L	10
Thermanit A	EN ISO 14343-A	S 19 12 3 Nb	ER318	11
Thermanit H-347	EN ISO 14343-A	S 19 9 Nb	ER347	12
Avesta 2205	EN ISO 14343-A	S 22 9 3 N L	ER2209	13
Thermanit 22/09	EN ISO 14343-A	S 22 9 3 N L	ER2209	14
Avesta P5	EN ISO 14343-A	S 23 12 2 L	ER309LMo(mod.)	15
Avesta LDX 2101	EN ISO 14343-A	S 23 7 N L	-	16
Avesta 2507/P100	EN ISO 14343-A	S 25 9 4 N L	ER2594	17
BÖHLER CN 13/4-UP	EN ISO 14343-A	S 13 4	ER410NiMo (mod.)	18
Avesta P12	EN ISO 18274	S Ni 6625 (NiCr22Mo9Nb)	ERNiCrMo-3	19
Thermanit 625	EN ISO 18274	S Ni 6625 (NiCr22Mo9Nb)	ERNiCrMo-3	20
UTP UP 6222 Mo	EN ISO 18274	S Ni 6625 (NiCr22Mo9Nb)	ERNiCrMo-3	21
Thermanit NicrO 82	EN ISO 18274	S Ni 6082 (NiCr20Mn3Nb)	ERNiCr-3	22
Thermanit Nimco C 276	EN ISO 18274	S Ni 6276 (NiCr15Mo16Fe6W4)	ERNiCrMo-4	23

9

## Chapter 4.3 - SAW Flux

Product Name	EN/ISO-Standard	EN/ISO-Classification	Chapter Page
BÖHLER BB 418 TT	EN ISO 14174	SA FB 1 55 AC H5	2,3
UV 418 TT	EN ISO 14174	SA FB 1 55 AC H5	3,4,5
UV 421 TT	EN ISO 14174	SA FB 1 55 AC H5	6,7,8
BÖHLER BB 24	EN ISO 14174	SA FB 1 65 DC H5	9,10
UV 420 TT	EN ISO 14174	SA FB 1 65 DC / SA FB 1 65 DC H5	11,12,13
UV 420 TTR / UV 420 TTR-W	EN ISO 14174	SA FB 1 65 DC / SA FB 1 65 AC	14,15,16
UV 420 TTR-C	EN ISO 14174	SA FB 1 65 DC	17
UV 310 P	EN ISO 14174	SAAB 1 55 AC H5	18
BÖHLER BB 400	EN ISO 14174	SAAB 1 67 AC H5	19
UV 400	EN ISO 14174	SAAB 1 67 AC H5	20, 21
UV 309 P	EN ISO 14174	SAAB 1 65 AC H5	22
UV 305	EN ISO 14174	SAAR 1 76 AC H5	23
UV 306	EN ISO 14174	SAAR 1 77 AC H5	24,25
Avesta FLUX 805	EN ISO 14174	SAAF 2 Cr DC	26
BÖHLER BB 202	EN ISO 14174	SA FB 2 DC	27
Marathon 431	EN ISO 14174	SA FB 2 64 DC	28,29
BÖHLER BB 910	EN ISO 14174	SA FB 2 DC H5	30
Marathon 543	EN ISO 14174	SA FB 2 55 DC H5	31
Avesta FLUX 801	EN ISO 14174	SA CS 2 Cr DC	32

## Chapter 5.1 - Flux cored wire (unalloyed, low-alloyed)

Product Name	EN/ISO-Standard	EN/ISO-Classification	AWS-Classification	Chapter Page
BÖHLER Ti 52-FD	EN ISO 17633-A	T 46 4 P M 1 H10 / T 42 2 P C 1 H5	E71T1-M21A4-CS1-H8; E71T1-C1A2-CS1-H4	2
Union TG 55 M	EN ISO 17633-A	T 46 4 P M 1 H10 / T 42 2 P C 1 H5	E71T1-MJH8 / E71T1-1CH8	3
BÖHLER PIPESHIELD 71 T8-FD	-	-	E71T8-A4-K6	4
BÖHLER PIPESHIELD 81 T8-FD	-	-	E81T8-A4-G; E81T8-A4-N2	5
BÖHLER Ti 60-FD	EN ISO 17633-A	T 50 6 1Ni P M 1 H5	E81T1-M21A8-Ni1-H4	6
BÖHLER Ti 70 PIPE-FD	EN 18276-A	T 55 4 Mn1Ni P M 1H5	E91T1-M21A4-G	7
BÖHLER DMO Ti-FD	EN ISO 17634-A	T MoL P M 1 H10	E81T1-M21PY-A1H8	8
BÖHLER DCMS Ti-FD	EN ISO 17634-A	T CrMo1 P M 1 H10	E81T1-M21PY-B2H8	9

## Chapter 5.2 - Flux cored wire (high-alloyed)

Avesta FCW-2D 308L/MVR	EN ISO 17633-A	T 19 9 L R M/C 3	E308LT0-4; E308LT0-1	2
Avesta FCW 308L/MVR-PW	EN ISO 17633-A	T 19 9 L R M/C 1	E308LT1-4; E308LT1-1	3
BÖHLER EAS 2-FD	EN ISO 17633-A	T 19 9 L R M(C) 3	E308LT0-4; E308LT0-1	4
BÖHLER EAS 2 PW-FD	EN ISO 17633-A	T 19 9 L P M(C) 1	E308LT1-4; E308LT1-1	5
Thermanit TG 308 L	EN ISO 17633-A	T 19 9 L R M/C3	E308LT0-4; E308LT0-1	6
Avesta FCW-2D 309L	EN ISO 17633-A	T 23 12 L R M/C 3	E309LT0-4; E309LT0-1	7
Avesta FCW 309L-PW	EN ISO 17633-A	T 23 12 L P M/C1	E309LT1-4; E309LT1-1	8
BÖHLER CN 23/12-FD	EN ISO 17633-A	T 23 12 L R M(C) 3	E309LT0-1; E309LT0-4	9
BÖHLER CN 23/12 PW-FD	EN ISO 17633-A	T 23 12 L P M/C1	E309LT1-4; E309LT1-1	10
Thermanit TG 309 L	EN ISO 17633-A	T 23 12 L R M(C) 3	E309LT0-4; E309LT0-1	11
Avesta FCW-2D 316L/SKR	EN ISO 17633-A	T 19 12 3 L R M/C3	E316LT0-4; E316LT0-1	12
Avesta FCW 316L/SKR-PW	EN ISO 17633-A	T 19 12 3 L P M/C1	E316LT1-4; E316LT1-1	13
BÖHLER EAS 4 M-FD	EN ISO 17633-A	T 19 12 3 L R M(C) 3	E316LT0-4; E316LT0-1	14
BÖHLER EAS 4 PW-FD	EN ISO 17633-A	T 19 12 3 L P M/C1	E316LT1-4; E316LT1-1	15
BÖHLER EAS 4 PW-FD (LF)	EN ISO 17633-A	T Z19 12 3 L P M/C1	E316LT1-4; E316LT1-1	16
Thermanit TG 316 L	EN ISO 17633-A	T 19 12 3 L R M(C) 3	E316LT0-4; E316LT0-1	17
Avesta FCW-2D 347/MVNB	EN ISO 17633-A	T 19 9 Nb R M/C3	E347T0-4; E347T0-1	18
BÖHLER SAS 2-FD	EN ISO 17633-A	T 19 9 Nb R M(C) 3	E347T0-4; E347T0-1	19
BÖHLER SAS 2 PW-FD	EN ISO 17633-A	T 19 9 Nb P M(C) 1	E347T1-4; E347T1-1	20
Avesta FCW-2D 2205	EN ISO 17633-A	T 22 9 3 NL R M/C3	E2209T0-4; E2209T0-1	21
Avesta FCW 2205-PW	EN ISO 17633-A	T 22 9 3 N L P M(C) 1	E2209T1-4; E2209T1-1	22
BÖHLER CN 22/9 PW-FD	EN ISO 17633-A	T 22 9 3 NL P M(C) 1	E2209T1-4; E2209T1-1	23
Avesta FCW-2D LDX 2101	EN ISO 17633-A	T Z 24 9 N L R M(C) 3	E2307T0-4; E2307T0-1	24
Avesta FCW LDX 2101-PW	EN ISO 17633-A	T Z 24 9 N L P M(C) 1	E2307T1-4; E2307T1-1	25
Avesta FCW 2507/P100-PW	EN ISO 17633-A	T 25 9 4 N L P M21 (C)1 2	E2594T1-4; E2594T1-1	26
BÖHLER A7 FD	EN ISO 17633-A	T 18 8 Mn R M(C) 3	E307T0-G	27
BÖHLER A 7-MC	EN ISO 17633-A	T 18 8 Mn M M 1	EC307 (mod.)	28
Avesta FCW-2D P5	EN ISO 17633-A	T 23 12 2 L R M/C3	E309LMoT0-4; E309LMoT0-1	29
BÖHLER CN 23/12 Mo-FD	EN ISO 17633-A	T 23 12 2 L R M(C) 3	E309LMoT0-4; E309LMoT0-1	30
BÖHLER CN 23/12 Mo PW-FD	EN ISO 17633-A	T 23 12 2 L P M(C) 1	E309LMoT1-4; E309LMoT1-1	31
BÖHLER CN 13/4-MC	EN ISO 17633-A	T 13 4 M M 2	EC410NMo (mod.)	32
Avesta FCW P12-PW	EN ISO 12153	T Ni 6625 P M 2	ENiCrMo3T1-4	33
BÖHLER NiBAS 625 PW-FD	EN ISO 12153	T Ni 6625 P M 2	ENiCrMo3T1-4	34
UTP AF 6222 MoPW	EN ISO 12153	T Ni 6625 P M 2	ENiCrMo3T1-4	35
BÖHLER NiBAS 70/20-FD	EN ISO 12153	T Ni 6082 R M 3	ENiCr3T0-4	36
UTP AF 068 HH	EN ISO 12153	T Ni 6082 R M 3	ENiCr3T0-4	37

## Chapter 6.1 - Finishing Chemicals

Product Name	Chapter Page
Avesta PICKLING GEL 122	2
Avesta BLUEONE PICKLING PASTE 130	3
Avesta REDONE PICKLING PASTE 140	4
Avesta PICKLING SPRAY 204	5
Avesta REDONE PICKLING SPRAY 240	6
Avesta PICKLING BATH 302	7
Avesta CLEANER 401	8
Avesta PASSIVATOR 601	9
Avesta FINISHONE PASSIVATOR 630	10



## Table of Contents (alphabetical)

Product Name	EN/ISO-Standard	EN/ISO-Classification	AWS-Stand-ard	AWS-Classification	Chapter
Avesta 2205	EN ISO 3581	E 22 9 3 N L R	AWS A5.4	E2209-17	1.2
Avesta 2205	EN ISO 14343-A	W 22 9 3 N L	AWS A5.9	ER2209	2.2
Avesta 2205	EN ISO 14343-A	G 22 9 3 N L	AWS A5.9	ER2209	3.2
Avesta 2205	EN ISO 14343-A	S 22 9 3 N L	AWS A5.9	ER2209	4.2
Avesta 2205 basic	EN ISO 3581	E 22 9 3 N L B	AWS A5.4	E2209-15	1.2
Avesta 2205-PW AC/DC	EN ISO 3581	E 22 9 3 N L R	AWS A5.4	E2209-17	1.2
Avesta 2304	EN ISO 3581	E 23 7 N L R	-	-	1.2
Avesta 2507/P100	EN ISO 14343-A	W 25 9 4 N L	AWS A5.9	ER2594	2.2
Avesta 2507/P100	EN ISO 14343-A	G 25 9 4 N L	-	-	3.2
Avesta 2507/P100	EN ISO 14343-A	S 25 9 4 N L	AWS A5.9	ER2594	4.2
Avesta 2507/P100 RUTILE	EN ISO 3581	E 25 9 4 N L R	AWS A5.4	E2594-16	1.2
Avesta 253 MA	EN ISO 3581	E 21 10 R	-	-	1.2
Avesta 307-Si	EN ISO 14343-A	G 18 8 Mn	-	ER307 (mod.)	3.2
Avesta 308/308H AC/DC	EN ISO 3581	E 19 9 R	AWS A5.4	E308H-17	1.1
Avesta 308L/MVR	EN ISO 3581	E 19 9 L R	AWS A5.4	E308L-17	1.2
Avesta 308L/MVR	EN ISO 14343-A	W 19 9 L	AWS A5.9	ER308L	2.2
Avesta 308L/MVR	EN ISO 14343-A	S 19 9 L	AWS A5.9	ER308L	4.2
Avesta 308L-Si/MVR-Si	EN ISO 14343-A	W 19 9 L Si	AWS A5.9	ER308LSi	2.2
Avesta 308L-Si/MVR-Si	EN ISO 14343-A	G 19 9 L Si	AWS A5.9	ER308LSi	3.2
Avesta 309L	EN ISO 3581	E 23 12 L R	AWS A5.4	E309L-17	1.2
Avesta 309L	EN ISO 14343-A	S 23 12 L	AWS A5.9	ER309L	4.2
Avesta 309L-Si	EN ISO 14343-A	W 23 12 L Si	AWS A5.9	ER309LSi	2.2
Avesta 309L-Si	EN ISO 14343-A	G 23 12 L Si	AWS A5.9	ER309LSi	3.2
Avesta 310	EN ISO 3581	E 25 20 R	AWS A5.4	E310-17	1.2
Avesta 316L/SKR	EN ISO 3581	E 19 12 3 L R	AWS A5.4	E316L-17	1.2
Avesta 316L/SKR	EN ISO 14343-A	W 19 12 3 L	AWS A5.9	ER316L	2.2
Avesta 316L/SKR	EN ISO 14343-A	S 19 12 3 L	AWS A5.9	ER316L	4.2
Avesta 316L/SKR Cryo	EN ISO 3581	E 19 12 3 L R	AWS A5.4	E316L-16	1.2
Avesta 316L/SKR-2D	EN ISO 3581	E 19 12 3 L R	AWS A5.4	E316L-17	1.2
Avesta 316L/SKR-4D	EN ISO 3581	E 19 12 3 L R	AWS A5.4	E316L-17	1.2
Avesta 316L/SKR-PW AC/DC	EN ISO 3581	E 19 12 3 L R	AWS A5.4	E316L-17	1.2
Avesta 316L-Si/SKR-Si	EN ISO 14343-A	W 19 12 3 L Si	AWS A5.9	ER316LSi	2.2
Avesta 316L-Si/SKR-Si	EN ISO 14343-A	G 19 12 3 L Si	AWS A5.9	ER316LSi	3.2
Avesta 317L/SNR	-	-	AWS A5.4	E317L-17	1.2
Avesta 318-Si/SKnb-Si	EN ISO 14343-A	W 19 12 3 Nb Si	AWS A5.9	ER318(mod.)	2.2
Avesta 318-Si/SKnb-Si	EN ISO 14343-A	G 19 12 3 Nb Si	-	-	3.2
Avesta 347/MVnb	EN ISO 3581	E 19 9 Nb R	AWS A5.4	E347-17	1.2
Avesta 904L	EN ISO 3581	E 20 25 5 Cu N L R	AWS A5.4	E385-17	1.2
Avesta BLUEONE PICKLING PASTE 130	-	-	-	-	6.1
Avesta CLEANER 401	-	-	-	-	6.1
Avesta FCW 2205-PW	EN ISO 17633-A	T 22 9 3 N L P M(C) 1	AWS A5.22	E2209T1-4; E2209T1-1	5.2
Avesta FCW 2507/P100-PW	EN ISO 17633-A	T 25 9 4 N L P M21 (C1) 2	AWS A5.22	E2594T1-4; E2594T1-1	5.2
Avesta FCW 308L/MVR-PW	EN ISO 17633-A	T 19 9 L P M/C 1	AWS A5.22	E308LT1-4; E308LT1-1	5.2
Avesta FCW 309L-PW	EN ISO 17633-A	T 23 12 L P M/C1	AWS A5.22	E309LT1-4; E309LT1-1	5.2
Avesta FCW 316L/SKR-PW	EN ISO 17633-A	T 19 12 3 L P M/C1	AWS A5.22	E316LT1-4; E316LT1-1	5.2
Avesta FCW LDX 2101-PW	EN ISO 17633-A	T Z 24 9 N L P M(C) 1	AWS A5.22	E2307T1-4; E2307T1-1	5.2
Avesta FCW P12-PW	EN ISO 12153	T Ni 6625 P M 2	AWS A5.34	ENiCrMo3T1-4	5.2
Avesta FCW-2D 2205	EN ISO 17633-A	T 22 9 3 N L R M/C3	AWS A5.22	E2209T0-4; E2209T0-1	5.2
Avesta FCW-2D 308L/MVR	EN ISO 17633-A	T 19 9 L R M/C 3	AWS A5.22	E308LT0-4; E308LT0-1	5.2
Avesta FCW-2D 309L	EN ISO 17633-A	T 23 12 L R M/C 3	AWS A5.22	E309LT0-4; E309LT0-1	5.2
Avesta FCW-2D 316L/SKR	EN ISO 17633-A	T 19 12 3 L R M/C3	AWS A5.22	E316LT0-4; E316LT0-1	5.2
Avesta FCW-2D 347/MVnb	EN ISO 17633-A	T 19 9 Nb R M/C3	AWS A5.22	E347T0-4; E347T0-1	5.2
Avesta FCW-2D LDX 2101	EN ISO 17633-A	T Z 24 9 N L R M(C) 3	AWS A5.22	E2307T0-4; E2307T0-1	5.2

# Table of Contents (alphabetical) *cont.*

Product Name	EN/ISO-Standard	EN/ISO-Classification	AWS-Standard	AWS-Classification	Chapter
Avesta FCW-2D P5	EN ISO 17633-A	T 23 12 2 L R MIC3	AWS A5.22	E309LMoT0-4 ; E309LMoT0-1	5.2
Avesta FINISHONE PASSIVATOR 630	-	-	-	-	6.1
Avesta FLUX 801	EN ISO 14174	SA CS 2 Cr DC	-	-	4.3
Avesta FLUX 805	EN ISO 14174	SA AF 2 Cr DC	-	-	4.3
Avesta LDX 2101	EN ISO 3581	E 23 7 N L R	-	-	1.2
Avesta LDX 2101	EN ISO 14343-A	W 23 7 N L	-	-	2.2
Avesta LDX 2101	EN ISO 14343-A	G 23 7 N L	-	-	3.2
Avesta LDX 2101	EN ISO 14343-A	S 23 7 N L	-	-	4.2
Avesta P12	EN ISO 18274	S Ni 6625 (NiCr22Mo9Nb)	AWS A5.14	ERNiCrMo-3	2.2
Avesta P12	EN ISO 18274	S Ni 6625 (NiCr22Mo9Nb)	AWS A5.14	ERNiCrMo-3	3.2
Avesta P12	EN ISO 18274	S Ni 6625 (NiCr22Mo9Nb)	AWS A5.14	ERNiCrMo-3	4.2
Avesta P12-R basic	EN ISO 3581	E Ni Cr 22 Mo 9	AWS A5.11	ERNiCrMo-12	1.2
Avesta P5	EN ISO 3581	E 23 12 2 L R	AWS A5.4	E309MoL-17	1.2
Avesta P5	EN ISO 14343-A	W 23 12 2 L	AWS A5.09	ER309LMo(mod.)	2.2
Avesta P5	EN ISO 14343-A	G 23 12 2 L	-	-	3.2
Avesta P5	EN ISO 14343-A	S 23 12 2 L	-	ER309LMo(mod.)	4.2
Avesta P7 AC/DC	EN ISO 3581	E 29 9 R	-	-	1.2
Avesta PASSIVATOR 601	-	-	-	-	6.1
Avesta PICKLING BATH 302	-	-	-	-	6.1
Avesta PICKLING GEL 122	-	-	-	-	6.1
Avesta PICKLING SPRAY 204	-	-	-	-	6.1
Avesta REDONE PICKLING PASTE 140	-	-	-	-	6.1
Avesta REDONE PICKLING SPRAY 240	-	-	-	-	6.1
BÖHLER 2,5 Ni-IG	EN ISO 636-A	W 46 8 W2Ni2	AWS A5.28	ER80S-Ni2	2.1
BÖHLER 2,5 Ni-IG	EN ISO 14341-A	G 46 8 M21 2Ni2	AWS A5.28	ER80S-Ni2	3.1
BÖHLER 3 NiCrMo 2,5-UP + BB 24	EN ISO 26304-A	S 69 6 FB S3Ni2,5CrMo	AWS A5.23	F11A8-EM4 (mod.)-M4H4	4.1
BÖHLER 3 NiMo 1-UP + BB 24	EN ISO 26304-A	S 55 4 FB S3Ni1Mo	AWS A5.23	F9A4-EF3-F3	4.1
BÖHLER A 7 CN-IG	EN ISO 14343-A	W 18 8 Mn	AWS A5.9	ER307 (mod.)	2.2
BÖHLER A 7 CN-UP + BB 203	EN ISO 14343-A	S 18 8 Mn	AWS A5.9	ER307 (mod.)	4.2
BÖHLER A 7-IG / A 7 CN-IG	EN ISO 14343-A	G 18 8 Mn	AWS A5.9	ER307 (mod.)	3.2
BÖHLER A 7-MC	EN ISO 17633-A	T 18 8 Mn M M 1	AWS A5.9	EC307 (mod.)	5.2
BÖHLER A7 FD	EN ISO 17633-A	T 18 8 Mn R M(C) 3	AWS A5.22	E307T0-G	5.2
BÖHLER ASN 5-IG (Si)	EN ISO 14343-A	G Z18 16 5 N L	AWS A5.9	ER317L (mod.)	3.2
BÖHLER BB 202	EN ISO 14174	SA FB 2 DC	-	-	4.3
BÖHLER BB 24	EN ISO 14174	SA FB 1 65 DC H5	-	-	4.3
BÖHLER BB 400	EN ISO 14174	SA AB 1 67 AC H5	-	-	4.3
BÖHLER BB 418 TT	EN ISO 14174	SA FB 1 55 AC H5	-	-	4.3
BÖHLER BB 910	EN ISO 14174	SA FB 2 DC H5	-	-	4.3
BÖHLER C 9 MV-IG	EN ISO 21952-A	W CrMo91	AWS A5.28	ER90S-B9	2.1
BÖHLER C 9 MV-IG	EN ISO 21952-A	G CrMo91	AWS A5.28	ER90S-B9	3.1
BÖHLER C 9 MV-UP + BB 910	EN ISO 24598-A	S S CrMo91 FB	AWS A5.23	EB9	4.1
BÖHLER CAT 430L Cb-IG	EN ISO 14343-A	G Z 18 L Nb	AWS A5.9	ER430 (mod.)	3.2
BÖHLER CAT 430L CbTi-IG	EN ISO 14343-A	G Z Cr 18 NbTi L	AWS A5.9	ER430Nb (mod.)	3.2
BÖHLER CM 2-IG	EN ISO 21952-A	W CrMo2Si	AWS A5.28	ER90S-B3 (mod.)	2.1
BÖHLER CM 2-IG	EN ISO 21952-A	G CrMo2Si	AWS A5.28	ER90S-B3 (mod.)	3.1
BÖHLER CM 2-UP + BB 418 TT	EN ISO 24598-A	S S CrMo2 FB	AWS A5.23	F8P2-EB3-B3	4.1
BÖHLER CN 1314-IG	EN ISO 14343-A	W 13 4	AWS A5.9	ER410NiMo (mod.)	2.2
BÖHLER CN 1314-IG	EN ISO 14343-A	G 13 4	AWS A5.9	ER410NiMo (mod.)	3.2
BÖHLER CN 1314-MC	EN ISO 17633-A	T 13 4 M M 2	AWS A5.9	EC410NiMo (mod.)	5.2
BÖHLER CN 1314-UP	EN ISO 14343-A	S 13 4	AWS A5.9	ER410NiMo (mod.)	4.2
BÖHLER CN 2219 N-IG	EN ISO 14343-A	W 22 9 3 N L	AWS A5.9	ER2209	2.2
BÖHLER CN 2219 N-IG	EN ISO 14343-A	G 22 9 3 NL	AWS A5.9	ER2209	3.2
BÖHLER CN 2219 PW-FD	EN ISO 17633-A	T 22 9 3 NL P M(C) 1	AWS A5.22	E2209T1-4 ; E2209T1-1	5.2
BÖHLER CN 2312 Mo PW-FD	EN ISO 17633-A	T 23 12 2 L P M(C) 1	AWS A5.22	E309LMoT1-4 ; E309LMoT1-1	5.2
BÖHLER CN 2312 Mo-FD	EN ISO 17633-A	T 23 12 2 L R M(C) 3	AWS A5.22	E309LMoT0-4 ; E309LMoT0-1	5.2

# Table of Contents (alphabetical) *cont.*

Product Name	EN/ISO-Standard	EN/ISO-Classification	AWS-Stand- ard	AWS-Classification	Chapter
BÖHLER CN 23/12 PW-FD	EN ISO 17633-A	T 23 12 L P M/C1	AWS A5.22	E309LT1-4 ; E309LT1-1	5.2
BÖHLER CN 23/12-FD	EN ISO 17633-A	T 23 12 L R M(C) 3	AWS A5.22	E309LT0-1 ; E309LT0-4	5.2
BÖHLER CN 23/12-IG	EN ISO 14343-A	W 23 12 L	AWS A5.9	ER309L	2.2
BÖHLER CN 23/12-IG	EN ISO 14343-A	G 23 12 L	AWS A5.9	ER309L	3.2
BÖHLER CN 25/9 Cu-Ti-IG	EN ISO 14343-A	W 25 9 4 N L	AWS A5.9	ER2594	2.2
BÖHLER DCMS Ti-FD	EN ISO 17634-A	T CrMo1 P M 1 H10	AWS A5.29	E81T1-M21PY-B2H8	5.1
BÖHLER DCMS-IG	EN ISO 21952-A	W CrMo1Si	AWS A5.28	ER80S-B2 (mod.)	2.1
BÖHLER DCMS-IG	EN ISO 21952-A	G CrMo1Si	AWS A5.28	ER80S-G [ER80S-B2 (mod.)]	3.1
BÖHLER DMO	EN 12536	O IV	AWS A5.2	R60-G	2.1
BÖHLER DMO Ti-FD	EN ISO 17634-A	T MoL P M 1 H10	AWS A5.29	E81T1-M21PY-A1H8	5.1
BÖHLER DMO-IG	EN ISO 636-A	W MoSi	AWS A5.28	ER70S-A1	2.1
BÖHLER DMO-IG	EN ISO 21952-A	G MoSi	AWS A5.28	ER70S-A1	3.1
BÖHLER EAS 2 PW-FD	EN ISO 17633-A	T 19 9 L P M(C) 1	AWS A5.22	E308LT1-4 ; E308LT1-1	5.2
BÖHLER EAS 2-FD	EN ISO 17633-A	T 19 9 L R M(C) 3	AWS A5.22	E308LT0-4 ; E308LT0-1	5.2
BÖHLER EAS 2-IG (Si)	EN ISO 14343-A	G 19 9 L Si	AWS A5.9	ER308LSi	3.2
BÖHLER EAS 4 M-FD	EN ISO 17633-A	T 19 12 3 L R M(C) 3	AWS A5.22	E316LT0-4 ; E316LT0-1	5.2
BÖHLER EAS 4 M-IG	EN ISO 14343-A	W 19 12 3 L	AWS A5.9	ER316L	2.2
BÖHLER EAS 4 M-IG (Si)	EN ISO 14343-A	G 19 12 3 L Si	AWS A5.9	ER316LSi	3.2
BÖHLER EAS 4 M-UP + BB 202	EN ISO 14343-A	S 19 12 3 L	AWS A5.9	ER316L	4.2
BÖHLER EAS 4 PW-FD	EN ISO 17633-A	T 19 12 3 L P M/C1	AWS A5.22	E316LT1-4 ; E316LT1-1	5.2
BÖHLER EAS 4 PW-FD (LF)	EN ISO 17633-A	T 219 12 3 L P M/C1	AWS A5.22	E316LT1-4 ; E316LT1-1	5.2
BÖHLER EMK 6	EN ISO 636-A	W 42 5 W3Si1	AWS A5.18	ER70S-6	2.1
BÖHLER EMK 6	EN ISO 14341-A	G 42 4 M21 3Si1 / G 42 4 C1 3Si1	AWS A5.18	ER70S-6	3.1
BÖHLER EMK 8	EN ISO 14341-A	G 46 4 M21 4Si1 / G 46 4 C1 4Si1	AWS A5.18	ER70S-6	3.1
BÖHLER EML 5	EN ISO 636-A	W 46 5 W2Si	AWS A5.18	ER70S-3	2.1
BÖHLER EMS 2 + BB 24	EN ISO 14171-A	S 38 6 FB S2	AWS A5.17	F7A8-EM12K (F8P6-EM12K)	4.1
BÖHLER EMS 2 CrMo + BB 24	EN ISO 24598-A	S S CrMo1 FB	AWS A5.23	F8P2-EB2-B2	4.1
BÖHLER EMS 2 Mo + BB 24	EN ISO 14171-A	S 46 4 FB S2Mo	AWS A5.23	F8A4-EA2-A2/F8P0-EA2-A2	4.1
BÖHLER FA-IG	EN ISO 14343-A	W 25 4	-	-	2.2
BÖHLER FA-IG	EN ISO 14343-A	G 25 4	-	-	3.2
BÖHLER FFB-IG	EN ISO 14343-A	W 25 20 Mn	AWS A5.9	ER310 (mod.)	2.2
BÖHLER FFB-IG	EN ISO 14343-A	G 25 20 Mn	AWS A5.9	ER310 (mod.)	3.2
BÖHLER FF-IG	EN ISO 14343-A	W 22 12 H	AWS A5.9	ER309 (mod.)	2.2
BÖHLER FF-IG	EN ISO 14343-A	G 22 12 H	AWS A5.9	ER309 (mod.)	3.2
BÖHLER FOX 2.5 Ni	EN ISO 2560-A	E 46 8 2Ni B 42 H5	AWS A5.5	E8018-C1H4R	1.1
BÖHLER FOX 20 MWW	EN ISO 3580-A	E CrMoWV 12 B 4 2 H5	-	-	1.1
BÖHLER FOX A 7	EN ISO 3581	E 18 8 Mn B 2 2	AWS A5.4	E307-15 (mod.)	1.2
BÖHLER FOX A 7-A	EN ISO 3581	E 218 9 MnMo R 3 2	AWS A5.4	E307-16 (mod.)	1.2
BÖHLER FOX BVD 100	EN ISO 18275	E 62 5 Z2Ni B 45	AWS A5.5	E10045-P2 (mod.)	1.1
BÖHLER FOX BVD 85	EN ISO 2560-A	E 46 5 1Ni B 45	AWS A5.5	E8045-P2	1.1
BÖHLER FOX BVD 90	EN ISO 18275	E 55 5 Z2Ni B 45	AWS A5.5	E9045-P2 (mod.)	1.1
BÖHLER FOX C 9 MV	EN ISO 3580-A	E CrMo91 B 4 2 H5	AWS A5.5	E9015-B9	1.1
BÖHLER FOX CEL	EN ISO 2560-A	E 38 3 C 21	AWS A5.1	E6010	1.1
BÖHLER FOX CEL 75	EN ISO 2560-A	E 42 3 C 25	AWS A5.5	E7010-P1	1.1
BÖHLER FOX CEL 85	EN ISO 2560-A	E 46 4 1Ni C 25	AWS A5.5	E8010-P1	1.1
BÖHLER FOX CEL 90	EN ISO 2560-A	E 50 3 1Ni C 25	AWS A5.5	E9010-P1	1.1
BÖHLER FOX CEL Mo	EN ISO 2560-A	E 42 3 Mo C 25	AWS A5.5	E7010-A1	1.1
BÖHLER FOX CEL+	EN ISO 2560-A	E 38 2 C 21	AWS A5.1	E6010	1.1
BÖHLER FOX CM 2 Kb	EN ISO 3580-A	E CrMo2 B 4 2 H5	AWS A5.5	E9018-B3H4R	1.1
BÖHLER FOX CM 5 Kb	EN ISO 3580-A	E CrMo5 B 4 2 H5	AWS A5.5	E8018-B6H4R	1.1
BÖHLER FOX CM 9 Kb	EN ISO 3580-A	E CrMo9 B 4 2 H5	AWS A5.5	E8018-B8	1.1
BÖHLER FOX CN 13/4	EN ISO 3581	E 13 4 B 6 2	AWS A5.4	E410NiMo-15	1.2



# Table of Contents (alphabetical) *cont.*

Product Name	EN/ISO-Standard	EN/ISO-Classification	AWS-Stand- ard	AWS-Classification	Chapter
BÖHLER FOX CN 19/9 M	EN ISO 3581	E 20 10 3 R 3 2	AWS A5.4	E308Mo-17 (mod.)	1.2
BÖHLER FOX CN 20/25 M-A	EN ISO 3581	E 20 25 5 Cu N L R 3 2	AWS A5.4	E385-17 (mod.)	1.2
BÖHLER FOX CN 22/9 N	EN ISO 3581	E 22 9 3 N L R 3 2	AWS A5.4	E2209-17	1.2
BÖHLER FOX CN 23/12 Mo-A	EN ISO 3581	E 23 12 2 L R 3 2	AWS A5.4	E309LMo-17	1.2
BÖHLER FOX CN 23/12-A	EN ISO 3581	E 23 12 L R 3 2	AWS A5.4	E309L-17	1.2
BÖHLER FOX CN 29/9-A	EN ISO 3581	E 29 9 R 3 2	AWS A5.4	E312-17	1.2
BÖHLER FOX DCMS Kb	EN ISO 3580-A	E CrMo1 B 4 2 H5	AWS A5.5	E8018-B2H4R	1.1
BÖHLER FOX DMO Kb	EN ISO 3580-A	E Mo B 4 2 H5	AWS A5.5	E7018-A1H4R	1.1
BÖHLER FOX E 308 H	EN ISO 3581	E 19 9 H R 4 2	AWS A5.4	E308H-16	1.1
BÖHLER FOX EAS 2	EN ISO 3581	E 19 9 L B 2 2	AWS A5.4	E308L-15	1.2
BÖHLER FOX EAS 2-A	EN ISO 3581	E 19 9 L R 3 2	AWS A5.4	E308L-17	1.2
BÖHLER FOX EAS 4 M	EN ISO 3581	E 19 12 3 L B 2 2	AWS A5.4	E316L-15	1.2
BÖHLER FOX EAS 4 M-A	EN ISO 3581	E 19 12 3 L R 3 2	AWS A5.4	E316L-17	1.2
BÖHLER FOX ETI	EN ISO 2560-A	E 42 0 RR 12	AWS A5.1	E6013	1.1
BÖHLER FOX EV 47	EN ISO 2560-A	E 38 4 B 42 H5	AWS A5.1	E7016-1H4R	1.1
BÖHLER FOX EV 50	EN ISO 2560-A	E 42 5 B 42 H5	AWS A5.1	E7018-1H4R	1.1
BÖHLER FOX EV 50-A	EN ISO 2560-A	E 42 3 B 12 H10	AWS A5.1-04	E7016	1.1
BÖHLER FOX EV 60	EN ISO 2560-A	E 46 6 1Ni B 42 H5	AWS A5.5	E8018-C3H4R	1.1
BÖHLER FOX EV 65	EN ISO 18275	E 55 6 1NiMo B 42 H5	AWS A5.5	E8018-GH4R	1.1
BÖHLER FOX EV 85	EN ISO 18275	E 69 6 Mn2NiCrMo B 42 H5	AWS A5.5	E11018-GH4R	1.1
BÖHLER FOX EV PIPE	EN ISO 2560-A	E 42 4 B 12 H5	AWS A5.1	E7016-1H4R	1.1
BÖHLER FOX FFB	EN ISO 3581	E 25 20 B 2 2	AWS A5.4	E310-15 (mod.)	1.2
BÖHLER FOX FFB-A	EN ISO 3581	E 25 20 R 3 2	AWS A5.4	E310-16	1.2
BÖHLER FOX KE	EN ISO 2560-A	E 38 0 RC 11	AWS A5.1	E6013	1.1
BÖHLER FOX NIBAS 625	EN ISO 14172	E Ni 6625 (NiCr22Mo9Nb)	AWS A5.11	ENiCrMo-3	1.2
BÖHLER FOX NIBAS 70/20	EN ISO 14172	E Ni 6082 (NiCr20Mn3Nb)	AWS A5.11	ENiCrFe-3 (mod.)	1.2
BÖHLER FOX OHV	EN ISO 2560-A	E 38 0 RC 11	AWS A5.1	E6013	1.1
BÖHLER FOX P 92	EN ISO 3580-A	E ZCrMoWV Nb 9 0,5 2 B 4 2 H5	AWS A5.5	E9015-B9 (mod.)	1.1
BÖHLER FOX SAS 2	EN ISO 3581	E 19 9 Nb B 2 2	AWS A5.4	E347-15	1.2
BÖHLER FOX SAS 2-A	EN ISO 3581	E 19 9 Nb R 3 2	AWS A5.4	E347-17	1.2
BÖHLER FOX SAS 4	EN ISO 3581	E 19 12 3 Nb B 2 2	AWS A5.4	E318-15	1.2
BÖHLER FOX SAS 4-A	EN ISO 3581	E 19 12 3 Nb R 3 2	AWS A5.4	E318-17	1.2
BÖHLER Ni 1-IG	EN ISO 636-A	W3Ni1	AWS A5.28	ER80S-Ni1 (mod.)	2.1
BÖHLER Ni 2-UP + BB 24	EN ISO 14171-A	S 46 6 FB S2Ni2	AWS A5.23	F8A8-ENi2-Ni2	4.1
BÖHLER NIBAS 625 PW-FD	EN ISO 12153	T Ni 6625 P M 2	AWS A5.34	ENiCrMo3T1-4	5.2
BÖHLER NIBAS 625-IG	EN ISO 18274	S Ni 6625 (NiCr22Mo9Nb)	AWS A5.14	ERNiCrMo-3	2.2
BÖHLER NIBAS 625-IG	EN ISO 18274	S Ni 6625 (NiCr22Mo9Nb)	AWS A5.14	ERNiCrMo-3	3.2
BÖHLER NIBAS 70/20-FD	EN ISO 12153	T Ni 6082 R M 3	AWS A5.34	ENiCr3T0-4	5.2
BÖHLER NIBAS 70/20-IG	EN ISO 18274	S Ni 6082 (NiCr20Mn3Nb)	AWS A5.14	ERNiCr-3	2.2
BÖHLER NIBAS 70/20-IG	EN ISO 18274	S Ni 6082 (NiCr20Mn3Nb)	AWS A5.14	ERNiCr-3	3.2
BÖHLER NiCrMo 2,5-IG	EN ISO 16834-A	G 69 6 M21 Mn3Ni2.5CrMo / G 69 4 C1 Mn3Ni2.5CrMo	AWS A5.28	ER110S-G	3.1
BÖHLER NiCu 1-IG	EN ISO 14341-A	G 42 4 M21 Z3Ni1Cu / G 42 4 C1 Z3Ni1Cu	AWS A5.28	ER80S-G	3.1
BÖHLER NiMo 1-IG	EN ISO 16834-A	G 55 6 M21 Mn3Ni1Mo / G 55 4 C1 Mn3Ni1Mo	AWS A5.28	ER90S-G	3.1
BÖHLER PIPESHIELD 71 T8-FD	-	-	AWS A5.29	E71T8-A4-K6	5.1
BÖHLER PIPESHIELD 81 T8-FD	-	-	AWS A5.29	E81T8-A4-G ; E81T8-A4-Ni2	5.1
BÖHLER SAS 2 PW-FD	EN ISO 17633-A	T 19 9 Nb P M(C) 1	AWS A5.22	E347T1-4 ; E347T1-1	5.2
BÖHLER SAS 2-FD	EN ISO 17633-A	T 19 9 Nb R M(C) 3	AWS A5.22	E347T0-4 ; E347T0-1	5.2
BÖHLER SAS 2-IG	EN ISO 14343-A	W 19 9 Nb	AWS A5.9	ER347	2.2
BÖHLER SAS 2-IG (Si)	EN ISO 14343-A	G 19 9 Nb Si	AWS A5.9	ER347Si	3.2
BÖHLER SAS 4-IG	EN ISO 14343-A	W 19 12 3 Nb	AWS A5.9	ER318	2.2

# Table of Contents (alphabetical) *cont.*

Product Name	EN/ISO-Standard	EN/ISO-Classification	AWS-Stand-ard	AWS-Classification	Chapter
BÖHLER SG 8-P	EN ISO 14341-A	G 42 5 M21 3Ni1	AWS A5.28	ER80S-G	3.1
BÖHLER SKWAM-IG	EN ISO 14343-A	G Z 17 Mo	-	-	3.2
BÖHLER TI 52-FD	EN ISO 17632-A	T 46 4 P M 1 H10 / T 42 2 P C 1 H5	AWS A5.20	E71T1-M21A4-CS1-H8; E71T1-C1A2-CS1-H4	5.1
BÖHLER TI 60-FD	EN ISO 17632-A	T 50 6 1Ni P M 1 H5	AWS A5.29	E81T1-M21A8-Ni1-H4	5.1
BÖHLER TI 70 PIPE-FD	EN 18276-A	T 55 4 Mn1Ni P M 1H5	AWS A5.29	E91T1-M21A4-G	5.1
BÖHLER X 70-IG	EN ISO 16834-A	G 69 5 M21 Mn3Ni1CrMo	AWS A5.28	ER110S-G	3.1
BÖHLER X 90-IG	EN ISO 16834-A	G 89 6 M21 Mn4Ni2CrMo	AWS A5.28	ER120S-G	3.1
Marathon 431	EN ISO 14174	SA FB 2 64 DC	-	-	4.3
Marathon 543	EN ISO 14174	SA FB 2 55 DC H5	-	-	4.3
Phoenix 120 K	EN ISO 2560-A	E 42 5 B 32 H5	AWS A5.1	E7018-1	1.1
Phoenix Blau	EN ISO 2560-A	E 42 0 RC 11	AWS A5.1	E6013	1.1
Phoenix Cel 70	EN ISO 2560-A	E 42 2 C 25	AWS A5.1	E6010	1.1
Phoenix Cel 75	EN ISO 2560-A	E 42 2 C 25	AWS A5.5	E7010-P1	1.1
Phoenix Cel 80	EN ISO 2560-A	E 46 3 C 25	AWS A5.5	E8010-P1	1.1
Phoenix Cel 90	EN ISO 2560-A	E 50 3 1Ni C 25	AWS A5.5	E9010-G	1.1
Phoenix Chromo 1	EN ISO 3580-A	E CrMo 1 B 42 H5	AWS A5.5	E8018-B2	1.1
Phoenix Grün T	EN ISO 2560-A	E 42 0 RR 12	AWS A5.1	E6013	1.1
Phoenix SH Chromo 2 KS	EN ISO 3580-A	E CrMo 2 B 42 H5	AWS A5.5	E9015-B3	1.1
Phoenix SH Gelb R	EN ISO 2560-A	E 38 2 RB 12	AWS A5.1	E6013	1.1
Phoenix SH Kupfer 3 KC	EN ISO 3580-A	E ZCrMoV 1 B 42 H5	AWS A5.5	E9015-G	1.1
Phoenix SH Ni 2 K 100	EN ISO 18275-A	E 69 5 Mn2NiCrMo B 42 H5	AWS A5.5	E11018-G	1.1
Phoenix SH Schwarz 3 K	EN ISO 2560-A	E 50 4 Mo B 42	AWS A5.5	E7015-G	1.1
Phoenix SH Schwarz 3 K Ni	EN ISO 2560-A	E 50 4 1NiMo B 42 H5	AWS A5.5	E9018-G	1.1
Phoenix SH Schwarz 3 MK	EN ISO 3580-A	E Mo B 42 H5	AWS A5.5	E7018-A1	1.1
Phoenix SPEZIAL D	EN ISO 2560-A	E 42 3 B 12 H10	AWS A5.1-04	E 7016	1.1
Thermanit 17/15 TT	EN ISO 14343-A	G Z 17 15 Mn W	-	-	3.2
Thermanit 22/09	EN ISO 14343-A	W 22 9 3 N L	AWS A5.9	ER2209	2.2
Thermanit 22/09	EN ISO 14343-A	G 22 9 3 N L	AWS A5.9	ER2209	3.2
Thermanit 22/09	EN ISO 14343-A	S 22 9 3 N L	AWS A5.4	ER2209	4.2
Thermanit 25/09 CuT	EN ISO 3581	E 25 9 4 N L B 2 2	AWS A5.4	E2553-15 (mod.)	1.2
Thermanit 25/09 CuT	EN ISO 14343-A	W 25 9 4 N L	AWS A5.9	ER2594	2.2
Thermanit 25/09 CuT	EN ISO 14343-A	G 25 9 4 N L	AWS A5.9	ER2594	3.2
Thermanit 25/14 E-309L	EN ISO 14343-A	W 23 12 L	AWS A5.9	ER309L	2.2
Thermanit 25/14 E-309L	EN ISO 14343-A	S 23 12 L	AWS A5.9	ER309L	4.2
Thermanit 25/14 E-309L Si	EN ISO 14343-A	G 23 12 L Si	AWS A5.9	ER309LSi	3.2
Thermanit 25/22 H	EN ISO 3581	E 225 22 2 L B 2 2	-	-	1.2
Thermanit 30/10 W	EN 1600	E 29 9 R 12	AWS A5.4	E312-16 mod.	1.2
Thermanit 35/45 Nb	EN ISO 18274	S Ni Z (NiCr36Fe15Nb0,8)	-	-	2.2
Thermanit 35/45 Nb	EN ISO 18274	S Ni Z (NiCr36Fe15Nb0,8)	-	-	3.2
Thermanit 439 Ti	EN ISO 14343-A	G Z 18 Ti L	AWS A5.9	ER439 (mod.)	3.2
Thermanit 617	EN ISO 18274	S Ni 6617 (NiCr22Co12Mo9)	AWS A5.14	ERNiCrCoMo-1	2.2
Thermanit 617	EN ISO 18274	S Ni 6617 (NiCr22Co12Mo9)	AWS A5.14	ERNiCrCoMo-1	3.2
Thermanit 625	EN ISO 14172	E Ni 6625 (NiCr22Mo9Nb)	AWS A 5.11-05	E NiCrMo-3	1.2
Thermanit 625	EN ISO 18274	S Ni 6625 (NiCr22Mo9Nb)	AWS A5.14	ERNiCrMo-3	2.2
Thermanit 625	EN ISO 18274	S Ni 6625 (NiCr22Mo9Nb)	AWS A5.14	ERNiCrMo-3	3.2
Thermanit 625	EN ISO 18274	S Ni 6625 (NiCr22Mo9Nb)	AWS A5.14	ERNiCrMo-3	4.2
Thermanit A	EN ISO 14343-A	W 19 12 3 Nb	AWS A5.9	ER318	2.2
Thermanit A	EN ISO 14343-A	S 19 12 3 Nb	AWS A5.9	ER318	4.2
Thermanit A Si	EN ISO 14343-A	G 19 12 3 Nb Si	AWS A5.9	ER318 (mod.)	3.2
Thermanit ATS 4	EN 1600	E 19 9 H B 22	AWS A5.4	E308H-15	1.1
Thermanit ATS 4	EN ISO 14343-A	W 19 9 H	AWS A5.4	ER19-10H	2.1

# Table of Contents (alphabetical) *cont.*

Product Name	EN/ISO-Standard	EN/ISO-Classification	AWS-Standard	AWS-Classification	Chapter
Thermanit ATS 4	EN ISO 14343-A	G 19 9 H	AWS A5.9	ER19-10H	3.1
Thermanit AW	EN ISO 3581	E 19 12 3 Nb R 3 2	AWS A5.4	E318-17	1.2
Thermanit Chromo 9 V	EN ISO 3580-A	E CrMo 91 B 42 H5	AWS A5.5	E9015-B9	1.1
Thermanit D	EN ISO 14343-A	W 22 12 H	AWS A5.9	ER309 (mod.)	2.2
Thermanit D	EN ISO 14343-A	G 22 12 H	AWS A5.9	ER309 (mod.)	3.2
Thermanit GE-316L	EN ISO 14343-A	W 19 12 3 L	AWS A5.9	ER316L	2.2
Thermanit GE-316L	EN ISO 14343-A	S 19 12 3 L	AWS A5.9	ER316L	4.2
Thermanit GE-316L Si	EN ISO 14343-A	W 19 12 3 L Si	AWS A5.9	ER316L.Si	2.2
Thermanit GE-316L Si	EN ISO 14343-A	G 19 12 3 L Si	AWS A5.9	ER316L.Si	3.2
Thermanit GEW 316L-17	EN ISO 3581	E 19 12 3 L R 3 2	AWS A5.4	E316L-17	1.2
Thermanit H Si	EN ISO 14343-A	G 19 9 Nb Si	AWS A5.9	ER347Si	3.2
Thermanit H-347	EN ISO 14343-A	W 19 9 Nb	AWS A5.9	ER347	2.2
Thermanit H-347	EN ISO 14343-A	S 19 9 Nb	AWS A5.9	ER347	4.2
Thermanit JE-308L	EN ISO 14343-A	W 19 9 L	AWS A5.9	ER308L	2.2
Thermanit JE-308L	EN ISO 14343-A	S 19 9 L	AWS A5.9	ER308L	4.2
Thermanit JE-308L Si	EN ISO 14343-A	W 19 9 L Si	AWS A5.9	ER308L.Si	2.2
Thermanit JE-308L Si	EN ISO 14343-A	G 19 9 L Si	AWS A5.9	ER308L.Si	3.2
Thermanit JEW 308L-17	EN ISO 3581	E 19 9 L R 3 2	AWS A5.4	E308L-17	1.2
Thermanit L	EN ISO 14343-A	W 25 4	-	-	2.2
Thermanit L	EN ISO 14343-A	G 25 4	-	-	3.2
Thermanit MTS 3	EN ISO 3580-A	E CrMo 91 B 42 H5	AWS A5.5	E9015-B9	1.1
Thermanit MTS 3	EN ISO 21952-A	W CrMo91	AWS A5.28	ER90S-B9	2.1
Thermanit MTS 3	EN ISO 21952-A	G CrMo91	AWS A5.28	ER90S-B9	3.1
Thermanit MTS 3	EN ISO 24598-A	S CrMo91	AWS A5.28	EB9	4.1
Thermanit MTS 616	EN ISO 3580-A	E ZCrMoWVNB 9 0,5 2 B 4 2 H5	AWS A5.5	E9015-G	1.1
Thermanit MTS 616	EN ISO 21952-A	W Z CrMoWVNB 9 0,5 1,5	AWS A5.28	ER90S-G [ER90S-B9(mod.)]	2.1
Thermanit MTS 616	EN ISO 21952-A	G Z CrMoWVNB 9 0,5 1,5	AWS A5.28	ER90S-G [ER90S-B9(mod.)]	3.1
Thermanit MTS 616	EN ISO 24598-A	S ZCrMoWVNB 9 0,5 1,5	AWS A5.23	EG [EB9(mod.)]	4.1
Thermanit Nicro 182	EN ISO 14172	E Ni 6182 (NiCr15Fe6Mn)	AWS A5.11	ENiCrFe-3	1.2
Thermanit Nicro 82	EN ISO 14172	E Ni 6082 (NiCr20Mn3Nb)	AWS A 5.11-05	ENiCrFe-3 (mod.)	1.2
Thermanit Nicro 82	EN ISO 18274	S Ni 6082 (NiCr20Mn3Nb)	AWS A5.14	ERNiCr-3	2.2
Thermanit Nicro 82	EN ISO 18274	S Ni 6082 (NiCr20Mn3Nb)	AWS A5.14	ERNiCr-3	3.2
Thermanit Nicro 82	EN ISO 18274	S Ni 6082 (NiCr20Mn3Nb)	AWS A5.14	ERNiCr-3	4.2
Thermanit NiMo C 24	EN ISO 14172	E Ni 6059 (NiCr23Mo16)	AWS A5.11	ENiCrMo-13	1.2
Thermanit NiMo C 24	EN ISO 18274	S Ni 6059 (NiCr23Mo16)	AWS A5.14	ERNiCrMo-13	2.2
Thermanit NiMo C 24	EN ISO 18274	S Ni 6059 (NiCr23Mo16)	AWS A5.14	ERNiCrMo-13	3.2
Thermanit NiMo C 276	EN ISO 18274	S Ni 6276 (NiCr15Mo-16Fe6W4)	AWS A5.14	ERNiCrMo-4	4.2
Thermanit TG 308 L	EN ISO 17633-A	T 19 9 L R M/C3	AWS A5.22	E308LT0-4 ; E308LT0-1	5.2
Thermanit TG 309 L	EN ISO 17633-A	T 23 12 L R M(C) 3	AWS A5.22	E309LT0-4 ; E309LT0-1	5.2
Thermanit TG 316 L	EN ISO 17633-A	T 19 12 3 L R M(C) 3	AWS A5.22	E316LT0-4 ; E316LT0-1	5.2
Thermanit X	EN ISO 3581	E 18 8 Mn B 2 2	AWS A5.4	E307-15 (mod.)	1.2
Thermanit X	EN ISO 14343-A	W 18 8 Mn	AWS A5.9	ER307 (mod.)	2.2
Thermanit X	EN ISO 14343-A	G 18 8 Mn	AWS A5.9	ER307 (mod.)	3.2
Thermanit X	EN ISO 14343-A	S 18 8 Mn	AWS A5.9	ER307(mod.)	4.2
Thermanit XW	EN ISO 3581	E 18 8 Mn R 1 2	AWS A5.4	E307-16 (mod.)	1.2
Union I 52	EN ISO 636-A	W 42 5 W3Si1	AWS A5.18	ER70S-6	2.1
Union I CrMo	EN ISO 21952-A	W CrMo1Si	AWS A5.28	ER80S-G	2.1
Union I CrMo	EN ISO 21952-A	G CrMo1Si	AWS A5.28	ER80S-G [ER80S-B2 (mod.)]	3.1
Union I CrMo 910	EN ISO 21952-A	W CrMo2Si	AWS A5.28	ER90S-G	2.1
Union I CrMo 910	EN ISO 21952-A	G CrMo2Si	AWS A5.28	ER90S-G	3.1
Union I Mo	EN ISO 636-A	W 46 3 W2Mo	AWS A5.28	ER80S-G(A1)	2.1

# Table of Contents (alphabetical) *cont.*

Product Name	EN/ISO-Standard	EN/ISO-Classification	AWS-Standard	AWS-Classification	Chapter
Union I Mo	EN ISO 21952-A	G MoSi	AWS A5.28	ER80S-G(A1)	3.1
Union I P24	EN ISO 21952-A	W Z CrMo2V/Ti/Nb	AWS A5.28	ER90S-G	2.1
Union K 5 Ni	EN ISO 14341-A	G 50 5 M21 3Ni1/G 46 3 C1 3Ni1	AWS A5.28	ER80S-G	3.1
Union K 52	EN ISO 14341-A	G 42 2 C1 3Si1 / G 46 4 M21 3Si1	AWS A5.18	ER70S-6	3.1
Union K 52 Ni	EN ISO 14341-A	G 50 6 M21 Z3Ni1/G 46 4 C1 Z3Ni1	AWS A5.28	ER80S-G [ER80S-Ni1(mod.]]	3.1
Union K 56	EN ISO 14341-A	G 46 2 C G4Si1 / G 46 4 M G4Si1	-	ER70S-6	3.1
Union K NOVA Ni	EN ISO 14341-A	G 42 5 M21 3Ni1	AWS A5.28	ER80S-G [ER80S-Ni1(mod.]]	3.1
Union MoNi	EN ISO 16834-A	G 62 5 M21 Mn3Ni1Mo	AWS A5.28	ER90S-G	3.1
Union Ni 2,5	EN ISO 14341-A	G 50 7 M21 2Ni2	AWS A5.28	ER80S-Ni2	3.1
Union NiMoCr	EN ISO 16834-A	G 69 6 M21 Mn4Ni1,5CrMo	AWS A5.28	ER100S-G	3.1
Union S 1 CrMo 2	EN ISO 24598-A	S CrMo2	AWS A5.23	EB3R	4.1
Union S 1 CrMo 2 V	EN ISO 24598-A	S ZCrMoV2	AWS A5.23	EG	4.1
Union S 2	EN ISO 14171-A	S2	AWS A5.17	EM12	4.1
Union S 2 CrMo	EN ISO 24598-A	S CrMo1	AWS A5.23	EB2R	4.1
Union S 2 Mo	EN ISO 24598-A	S2Mo	AWS A5.23	EA2	4.1
Union S 2 Ni 2,5	EN ISO 14171-A	S2Ni2	AWS A5.23	ENi2	4.1
Union S 2 Ni 3,5	EN ISO 14171-A	S2Ni3	AWS A5.23	ENi3	4.1
Union S 2 NiMo 1	EN ISO 14171-A	SZ2Ni1Mo	AWS A5.23	ENi1	4.1
Union S 2 Si	EN ISO 14171-A	S2Si	AWS A5.17	EM12K	4.1
Union S 3	EN ISO 14171-A	S3	AWS A5.17	EH10K	4.1
Union S 3 Mo	EN ISO 24598-A	S3Mo	AWS A5.23	EA4	4.1
Union S 3 NiMo	EN ISO 14171-A	S3Ni1,5Mo	AWS A5.23	EG [EF1 (mod.]]	4.1
Union S 3 NiMo 1	EN ISO 14171-A	S3Ni1Mo	AWS A5.23	EF3	4.1
Union S 3 NiMoCr	EN ISO 26304-A	SZ3Ni2,5CrMo	AWS A5.23	EG [EF6 (mod.]]	4.1
Union S 3 Si	EN ISO 14171-A	S3Si	AWS A5.17	EH12K	4.1
Union S P 24	EN ISO 24598-A	S Z CrMo2VNb	AWS A5.23	EG	4.1
Union TG 55 M	EN ISO 17632-A	T 46 4 P M 1 H10 / T 42 2 P C 1 H5	AWS A5.20	E71T-1MJH8 / E71T-1CH8	5.1
Union X 85	EN ISO 16834-A	G 79 5 M21 Mn4Ni1,5CrMo	AWS A5.28	ER110S-G	3.1
Union X 90	EN ISO 16834-A	G 89 6 M21 Mn4Ni2CrMo	AWS A5.28	ER120S-G	3.1
Union X 96	EN ISO 16834-A	G 89 5 M21 Mn4Ni2,5CrMo	AWS A5.28	ER120S-G	3.1
UTP 068 HH	EN ISO 14172	E Ni 6082 (NiCr20Mn3Nb)	AWS A 5.11	E NiCrFe-3 (mod.)	1.2
UTP 2133 Mn	EN ISO 3581	E Z 2133 B 42	-	-	1.2
UTP 2535 Nb	EN ISO 3581	E Z 25 35 Nb B62	-	-	1.2
UTP 6170 CO	EN ISO 14172	E Ni 6117 (NiCr22Co12Mo)	AWS A 5.11	~E NiCrCoMo-1	1.2
UTP 6222 Mo	EN ISO 14172	E Ni 6625 (NiCr22Mo9Nb)	AWS A 5.11	E NiCrMo-3	1.2
UTP 65	EN ISO 3581	E 29 9 R 3 2	-	-	1.2
UTP 65 D	EN ISO 3581	E 29 9 R 12	-	-	1.2
UTP 7013 Mo	EN ISO 14172	E Ni 6620 (NiCr14Mo7Fe)	AWS A5.11	E NiCrMo-6	1.2
UTP 7015	EN ISO 14172	E Ni 6182 (NiCr15Fe6Mn)	AWS A 5.11	E Ni Cr Fe-3	1.2
UTP 7015 Mo	EN ISO 14172	E Ni 6093 (NiCr15Fe8NbMo)	AWS A 5.11	E Ni Cr Fe-2	1.2
UTP 759 Kb	EN ISO 14172	E Ni 6059 (NiCr23Mo16)	AWS A5.11	ENiCrMo-13	1.2
UTP 80 M	EN ISO 14172	E Ni 4060 (NiCu30Mn3Ti)	AWS A 5.11	ENiCu-7	1.2
UTPA 068 HH	EN ISO 18274	S Ni 6082 (NiCr20Mn3Nb)	AWS A5.14	ERNiCr-3	2.2
UTPA 068 HH	EN ISO 18274	S Ni 6082 (NiCr20Mn3Nb)	AWS A5.14	ERNiCr-3	3.2
UTPA A 2133 Mn	EN ISO 14343-A	W Z 21 33 Mn Nb	-	-	2.2
UTPA A 2133 Mn	EN ISO 14343-A	G Z 21 33 Mn Nb	-	-	3.2
UTPA A 2535 Nb	EN ISO 14343-A	W Z 25 35 Zr	-	-	2.2
UTPA A 2535 Nb	EN ISO 14343-A	G Z 25 35 Zr	-	-	3.2
UTPA A 3545 Nb	EN ISO 14343-A	W Z 35 45 Nb	-	-	2.2
UTPA A 3545 Nb	EN ISO 14343-A	G Z 35 45 Nb	-	-	3.2

## Table of Contents (alphabetical) *cont.*

Product Name	EN/ISO-Standard	EN/ISO-Classification	AWS-Stand- ard	AWS-Classification	Chapter
UTP A 6170 Co	EN ISO 18274	S Ni 6617 (NiCr22Co12Mo9)	AWS A5.14	ERNiCrCoMo-1	2.2
UTP A 6170 Co	EN ISO 18274	S Ni 6617 (NiCr22Co12Mo9)	AWS A5.14	ERNiCrCoMo-1	3.2
UTP A 6222 Mo	EN ISO 18274	S Ni 6625 (NiCr22Mo9Nb)	AWS A5.14	ER NiCrMo-3	2.2
UTP A 6222 Mo	EN ISO 18274	S Ni 6625 (NiCr22Mo9Nb)	AWS A5.14	ERNiCrMo-3	3.2
UTP A 759	EN ISO 18274	S Ni 6059 (NiCr23Mo16)	AWS A5.14	ER NiCrMo-13	2.2
UTP A 759	EN ISO 18274	S Ni 6059 (NiCr23Mo16)	AWS A5.14	ER NiCrMo-13	3.2
UTP A 776	EN ISO 18274	S Ni 6276 (NiCr15Mo-16Fe6W4)	AWS A5.14	ERNiCrMo-4	2.2
UTP A 776	EN ISO 18274	S Ni 6276 (NiCr15Mo-16Fe6W4)	AWS A5.14	ERNiCrMo-4	3.2
UTP A 80 M	EN ISO 18274	S Ni 4060 (NiCu30Mn3Ti)	AWS A5.14	ERNiCu-7	2.2
UTP A 80 M	EN ISO 18274	S Ni 4060 (NiCu30Mn3Ti)	AWS A5.14	ERNiCu-7	3.2
UTP AF 068 HH	EN ISO 12153	T Ni 6082 R M 3	AWS A5.34	ENiCr3TO-4	5.2
UTP AF 6222 MoPW	EN ISO 12153	T Ni 6625 P M 2	AWS A5.34	ENiCrMo3T1-4	5.2
UTP COMET J 50 N	EN ISO 2560-A	E 42 3 B 12 H 10	AWS A 5.1	E 7016	1.1
UTP UP 6222 Mo	EN ISO 18274	S Ni 6625 (NiCr22Mo9Nb)	AWS A5.14	ERNiCrMo-3	4.2
UV 305	EN ISO 14174	SA AR 1 76 AC H5	-	-	4.3
UV 306	EN ISO 14174	SA AR 1 77 AC H5	-	-	4.3
UV 309 P	EN ISO 14174	SA AB 1 65 AC H5	-	-	4.3
UV 310 P	EN ISO 14174	SA AB 1 55 AC H5	-	-	4.3
UV 400	EN ISO 14174	SA AB 1 67 AC H5	-	-	4.3
UV 418 TT	EN ISO 14174	SA FB 1 55 AC H5	-	-	4.3
UV 420 TT	EN ISO 14174	SA FB 1 65 DC / SA FB 1 65 DC H5	-	-	4.3
UV 420 TTR	EN ISO 14174	SA FB 1 65 DC / SA FB 1 65 AC	-	-	4.3
UV 420 TTR-C	EN ISO 14174	SA FB 1 65 DC	-	-	4.3
UV 420 TTR-W	EN ISO 14174	SA FB 1 65 AC	-	-	4.3
UV 421 TT	EN ISO 14174	SA FB 1 55 AC H5	-	-	4.3

# Table of Contents (EN ISO)

Product Name	EN/ISO-Standard	EN/ISO-Classification	AWS-Standard	AWS-Classification	Chapter
Avesta 317L/SNR	-	-	AWS A5.4	E317L-17	1.2
Avesta BLUEONE PICKLING PASTE 130	-	-	-	-	6.1
Avesta CLEANER 401	-	-	-	-	6.1
Avesta FINISHONE PASSIVATOR 630	-	-	-	-	6.1
Avesta PASSIVATOR 601	-	-	-	-	6.1
Avesta PICKLING BATH 302	-	-	-	-	6.1
Avesta PICKLING GEL 122	-	-	-	-	6.1
Avesta PICKLING SPRAY 204	-	-	-	-	6.1
Avesta REDONE PICKLING PASTE 140	-	-	-	-	6.1
Avesta REDONE PICKLING SPRAY 240	-	-	-	-	6.1
BÖHLER PIPESHIELD 71 T8-FD	-	-	AWS A5.29	E71T8-A4-K6	5.1
BÖHLER PIPESHIELD 81 T8-FD	-	-	AWS A5.29	E81T8-A4-G ; E81T8-A4-Ni2	5.1
BÖHLER FOX CN 13/4	EN ISO 3581	E 13 4 B 2	AWS A5.4	E410NiMo-15	1.2
BÖHLER FOX A 7	EN ISO 3581	E 18 8 Mn B 2 2	AWS A5.4	E307-15 (mod.)	1.2
Thermanit X	EN ISO 3581	E 18 8 Mn B 2 2	AWS A5.4	E307-15 (mod.)	1.2
Thermanit XW	EN ISO 3581	E 18 8 Mn R 1 2	AWS A5.4	E307-16 (mod.)	1.2
BÖHLER FOX EAS 4 M	EN ISO 3581	E 19 12 3 L B 2 2	AWS A5.4	E316L-15	1.2
Avesta 316L/SKR	EN ISO 3581	E 19 12 3 L R	AWS A5.4	E316L-17	1.2
Avesta 316L/SKR Cryo	EN ISO 3581	E 19 12 3 L R	AWS A5.4	E316L-16	1.2
Avesta 316L/SKR-2D	EN ISO 3581	E 19 12 3 L R	AWS A5.4	E316L-17	1.2
Avesta 316L/SKR-4D	EN ISO 3581	E 19 12 3 L R	AWS A5.4	E316L-17	1.2
Avesta 316L/SKR-PW AC/DC	EN ISO 3581	E 19 12 3 L R	AWS A5.4	E316L-17	1.2
BÖHLER FOX EAS 4 M-A	EN ISO 3581	E 19 12 3 L R 3 2	AWS A5.4	E316L-17	1.2
Thermanit GEW 316L-17	EN ISO 3581	E 19 12 3 L R 3 2	AWS A5.4	E316L-17	1.2
BÖHLER FOX SAS 4	EN ISO 3581	E 19 12 3 Nb B 2 2	AWS A5.4	E318-15	1.2
BÖHLER FOX SAS 4-A	EN ISO 3581	E 19 12 3 Nb R 3 2	AWS A5.4	E318-17	1.2
Thermanit AW	EN ISO 3581	E 19 12 3 Nb R 3 2	AWS A5.4	E318-17	1.2
Thermanit ATS 4	EN 1600	E 19 9 HB 2 2	AWS A5.4	E308H-15	1.1
BÖHLER FOX E 308 H	EN ISO 3581	E 19 9 HR 4 2	AWS A5.4	E308H-16	1.1
BÖHLER FOX EAS 2	EN ISO 3581	E 19 9 L B 2 2	AWS A5.4	E308L-15	1.2
Avesta 308L/MVR	EN ISO 3581	E 19 9 L R	AWS A5.4	E308L-17	1.2
BÖHLER FOX EAS 2-A	EN ISO 3581	E 19 9 L R 3 2	AWS A5.4	E308L-17	1.2
Thermanit JEW 308L-17	EN ISO 3581	E 19 9 L R 3 2	AWS A5.4	E308L-17	1.2
BÖHLER FOX SAS 2	EN ISO 3581	E 19 9 Nb B 2 2	AWS A5.4	E347-15	1.2
Avesta 347/MVNB	EN ISO 3581	E 19 9 Nb R	AWS A5.4	E347-17	1.2
BÖHLER FOX SAS 2-A	EN ISO 3581	E 19 9 Nb R 3 2	AWS A5.4	E347-17	1.2
Avesta 308/308H AC/DC	EN ISO 3581	E 19 9 R	AWS A5.4	E308H-17	1.1
BÖHLER FOX CN 19/9 M	EN ISO 3581	E 20 10 3 R 3 2	AWS A5.4	E308Mo-17 (mod.)	1.2
Avesta 904L	EN ISO 3581	E 20 25 5 Cu N L R	AWS A5.4	E385-17	1.2
BÖHLER FOX CN 20/25 M-A	EN ISO 3581	E 20 25 5 Cu N L R 3 2	AWS A5.4	E385-17 (mod.)	1.2
Avesta 253 MA	EN ISO 3581	E 21 10 R	-	-	1.2
Avesta 2205 basic	EN ISO 3581	E 22 9 3 N L B	AWS A5.4	E2209-15	1.2
Avesta 2205	EN ISO 3581	E 22 9 3 N L R	AWS A5.4	E2209-17	1.2
Avesta 2205-PW AC/DC	EN ISO 3581	E 22 9 3 N L R	AWS A5.4	E2209-17	1.2
BÖHLER FOX CN 22/9 N	EN ISO 3581	E 22 9 3 N L R 3 2	AWS A5.4	E2209-17	1.2
Avesta P5	EN ISO 3581	E 23 12 2 L R	AWS A5.4	E309MoL-17	1.2
BÖHLER FOX CN 23/12 Mo-A	EN ISO 3581	E 23 12 2 L R 3 2	AWS A5.4	E309Lmo-17	1.2
Avesta 309L	EN ISO 3581	E 23 12 L R	AWS A5.4	E309L-17	1.2
BÖHLER FOX CN 23/12-A	EN ISO 3581	E 23 12 L R 3 2	AWS A5.4	E309L-17	1.2
Avesta 2304	EN ISO 3581	E 23 7 N L R	-	-	1.2
Avesta LDX 2101	EN ISO 3581	E 23 7 N L R	-	-	1.2
BÖHLER FOX FFB	EN ISO 3581	E 25 20 B 2 2	AWS A5.4	E310-15 (mod.)	1.2
Avesta 310	EN ISO 3581	E 25 20 R	AWS A5.4	E310-17	1.2

# Table of Contents (EN ISO) *cont.*

Product Name	EN/ISO-Standard	EN/ISO-Classification	AWS-Stand- ard	AWS-Classification	Chapter
BÖHLER FOX FFB-A	EN ISO 3581	E 25 20 R 3 2	AWS A5.4	E310-16	1.2
Thermit 25/09 CuT	EN ISO 3581	E 25 9 4 N L B 2 2	AWS A5.4	E2553-15 (mod.)	1.2
Avesta 2507/P100 RUTILE	EN ISO 3581	E 25 9 4 N L R	AWS A5.4	E2594-16	1.2
Avesta P7 AC/DC	EN ISO 3581	E 29 9 R	-	-	1.2
Thermit 30/10 W	EN 1600	E 29 9 R 12	AWS A5.4	E312-16 mod.	1.2
UTP 65 D	EN ISO 3581	E 29 9 R 12	-	-	1.2
BÖHLER FOX CN 29/9-A	EN ISO 3581	E 29 9 R 3 2	AWS A5.4	E312-17	1.2
UTP 65	EN ISO 3581	E 29 9 R 3 2	-	-	1.2
BÖHLER FOX KE	EN ISO 2560-A	E 38 0 RC 11	AWS A5.1	E6013	1.1
BÖHLER FOX OHV	EN ISO 2560-A	E 38 0 RC 11	AWS A5.1	E6013	1.1
BÖHLER FOX CEL+	EN ISO 2560-A	E 38 2 C 21	AWS A5.1	E6010	1.1
Phoenix SH Gelb R	EN ISO 2560-A	E 38 2 RB 12	AWS A5.1	E6013	1.1
BÖHLER FOX CEL	EN ISO 2560-A	E 38 3 C 21	AWS A5.1	E6010	1.1
BÖHLER FOX EV 47	EN ISO 2560-A	E 38 4 B 42 H5	AWS A5.1	E7016-1H4R	1.1
Phoenix Blau	EN ISO 2560-A	E 42 0 RC 11	AWS A5.1	E6013	1.1
BÖHLER FOX ETI	EN ISO 2560-A	E 42 0 RR 12	AWS A5.1	E6013	1.1
Phoenix Grün T	EN ISO 2560-A	E 42 0 RR 12	AWS A5.1	E6013	1.1
Phoenix Cel 70	EN ISO 2560-A	E 42 2 C 25	AWS A5.1	E6010	1.1
Phoenix Cel 75	EN ISO 2560-A	E 42 2 C 25	AWS A5.5	E7010-P1	1.1
UTP COMET J 50 N	EN ISO 2560-A	E 42 3 B 12 H 10	AWS A 5.1	E 7016	1.1
BÖHLER FOX EV 50-A	EN ISO 2560-A	E 42 3 B 12 H10	AWS A5.1-04	E7016	1.1
Phoenix SPEZIAL D	EN ISO 2560-A	E 42 3 B 12 H10	AWS A5.1-04	E 7016	1.1
BÖHLER FOX CEL 75	EN ISO 2560-A	E 42 3 C 25	AWS A5.5	E7010-P1	1.1
BÖHLER FOX CEL Mo	EN ISO 2560-A	E 42 3 Mo C 25	AWS A5.5	E7010-A1	1.1
BÖHLER FOX EV PIPE	EN ISO 2560-A	E 42 4 B 12 H5	AWS A5.1	E7016-1H4R	1.1
Phoenix 120 K	EN ISO 2560-A	E 42 5 B 32 H5	AWS A5.1	E7018-1	1.1
BÖHLER FOX EV 50	EN ISO 2560-A	E 42 5 B 42 H5	AWS A5.1	E7018-1H4R	1.1
Phoenix Cel 80	EN ISO 2560-A	E 46 3 C 25	AWS A5.5	E8010-P1	1.1
BÖHLER FOX CEL 85	EN ISO 2560-A	E 46 4 1Ni C 25	AWS A5.5	E8010-P1	1.1
BÖHLER FOX BVD 85	EN ISO 2560-A	E 46 5 1Ni B 45	AWS A5.5	E8045-P2	1.1
BÖHLER FOX EV 60	EN ISO 2560-A	E 46 6 1Ni B 42 H5	AWS A5.5	E8018-C3H4R	1.1
BÖHLER FOX 2,5 Ni	EN ISO 2560-A	E 46 8 2Ni B 42 H5	AWS A5.5	E8018-C1H4R	1.1
BÖHLER FOX CEL 90	EN ISO 2560-A	E 50 3 1Ni C 25	AWS A5.5	E9010-P1	1.1
Phoenix Cel 90	EN ISO 2560-A	E 50 3 1Ni C 25	AWS A5.5	E9010-G	1.1
Phoenix SH Schwarz 3 K Ni	EN ISO 2560-A	E 50 4 1NiMo B 42 H5	AWS A5.5	E9018-G	1.1
Phoenix SH Schwarz 3 K	EN ISO 2560-A	E 50 4 Mo B 42	AWS A5.5	E7015-G	1.1
BÖHLER FOX BVD 90	EN ISO 18275	E 55 5 Z2Ni B 45	AWS A5.5	E9045-P2 (mod.)	1.1
BÖHLER FOX EV 65	EN ISO 18275	E 55 6 1NiMo B 42 H5	AWS A5.5	E8018-GH4R	1.1
BÖHLER FOX BVD 100	EN ISO 18275	E 62 5 Z2Ni B 45	AWS A5.5	E10045-P2 (mod.)	1.1
Phoenix SH Ni 2 K 100	EN ISO 18275-A	E 69 5 Mn2NiCrMo B 42 H5	AWS A5.5	E11018-G	1.1
BÖHLER FOX EV 85	EN ISO 18275	E 69 6 Mn2NiCrMo B 42 H5	AWS A5.5	E11018-GH4R	1.1
Phoenix Chromo 1	EN ISO 3580-A	E CrMo 1 B 42 H5	AWS A5.5	E8018-B2	1.1
Phoenix SH Chromo 2 KS	EN ISO 3580-A	E CrMo 2 B 42 H5	AWS A5.5	E9015-B3	1.1
Thermit Chromo 9 V	EN ISO 3580-A	E CrMo 91 B 42 H5	AWS A5.5	E9015-B9	1.1
Thermit MTS 3	EN ISO 3580-A	E CrMo 91 B 42 H5	AWS A5.5	E9015-B9	1.1
BÖHLER FOX DCMS Kb	EN ISO 3580-A	E CrMo1 B 4 2 H5	AWS A5.5	E8018-B2H4R	1.1
BÖHLER FOX CM 2 Kb	EN ISO 3580-A	E CrMo2 B 4 2 H5	AWS A5.5	E9018-B3H4R	1.1
BÖHLER FOX CM 5 Kb	EN ISO 3580-A	E CrMo5 B 4 2 H5	AWS A5.5	E8018-B6H4R	1.1
BÖHLER FOX CM 9 Kb	EN ISO 3580-A	E CrMo9 B 4 2 H5	AWS A5.5	E8018-B8	1.1
BÖHLER FOX C 9 MV	EN ISO 3580-A	E CrMo91 B 4 2 H5	AWS A5.5	E9015-B9	1.1
BÖHLER FOX 20 MVV	EN ISO 3580-A	E CrMoWV 12 B 4 2 H5	-	-	1.1
BÖHLER FOX DMO Kb	EN ISO 3580-A	E Mo B 4 2 H5	AWS A5.5	E7018-A1H4R	1.1

# Table of Contents (EN ISO) *cont.*

Product Name	EN/ISO-Standard	EN/ISO-Classification	AWS-Standard	AWS-Classification	Chapter
Phoenix SH Schwarz 3 MK	EN ISO 3580-A	E Mo B 42 H5	AWS A5.5	E7018-A1	1.1
UTP 80 M	EN ISO 14172	E Ni 4060 (NiCu30Mn3Ti)	AWS A 5.11	ENiCu-7	1.2
Thermanit NiMo C 24	EN ISO 14172	E Ni 6059 (NiCr23Mo16)	AWS A5.11	ENiCrMo-13	1.2
UTP 759 Kb	EN ISO 14172	E Ni 6059 (NiCr23Mo16)	AWS A5.11	ENiCrMo-13	1.2
BÖHLER FOX NIBAS 70/20	EN ISO 14172	E Ni 6082 (NiCr20Mn3Nb)	AWS A 5.11	ENiCrFe-3 (mod.)	1.2
Thermanit Nicro 82	EN ISO 14172	E Ni 6082 (NiCr20Mn3Nb)	AWS A 5.11-05	ENiCrFe-3 (mod.)	1.2
UTP 068 HH	EN ISO 14172	E Ni 6082 (NiCr20Mn3Nb)	AWS A 5.11	E NiCrFe-3 (mod.)	1.2
UTP 7015 Mo	EN ISO 14172	E Ni 6093(NiCr15Fe8NbMo)	AWS A 5.11	E Ni Cr Fe-2	1.2
UTP 6170 CO	EN ISO 14172	E Ni 6117 (NiCr22Co12Mo)	AWS A 5.11	-E NiCrCoMo-1	1.2
Thermanit Nicro 182	EN ISO 14172	E Ni 6182 (NiCr15Fe6Mn)	AWS A5.11	ENiCrFe-3	1.2
UTP 7015	EN ISO 14172	E Ni 6182 (NiCr15Fe6Mn)	AWS A 5.11	E Ni Cr Fe-3	1.2
UTP 7013 Mo	EN ISO 14172	E Ni 6620 (NiCr14Mo7Fe)	AWS A5.11	E NiCrMo-6	1.2
BÖHLER FOX NIBAS 625	EN ISO 14172	E Ni 6625 (NiCr22Mo9Nb)	AWS A5.11	ENiCrMo-3	1.2
Thermanit 625	EN ISO 14172	E Ni 6625 (NiCr22Mo9Nb)	AWS A 5.11-05	E NiCrMo-3	1.2
UTP 6222 Mo	EN ISO 14172	E Ni 6625 (NiCr22Mo9Nb)	AWS A 5.11	ENiCrMo-3	1.2
Avesta P12-R basic	EN ISO 3581	E Ni Cr 22 Mo 9	AWS A5.11	ERNiCrMo-12	1.2
UTP 2133 Mn	EN ISO 3581	E Z 2133 B 42	-	-	1.2
UTP 2535 Nb	EN ISO 3581	E Z 25 35 Nb B62	-	-	1.2
BÖHLER FOX A 7-A	EN ISO 3581	E Z 18 9 MnMo R 3 2	AWS A5.4	E307-16 (mod.)	1.2
Thermanit 25/22 H	EN ISO 3581	E Z25 22 2 L B 2 2	-	-	1.2
Phoenix SH Kupfer 3 KC	EN ISO 3580-A	E ZCrMoV 1 B 42 H5	AWS A5.5	E9015-G	1.1
BÖHLER FOX P 92	EN ISO 3580-A	E ZCrMoVVNb 9 0,5 2 B 4 2 H5	AWS A5.5	E9015-B9 (mod.)	1.1
Thermanit MTS 616	EN ISO 3580-A	E ZCrMoVVNb 9 0,5 2 B 4 2 H5	AWS A5.5	E9015-G	1.1
BÖHLER CN 13/4-IG	EN ISO 14343-A	G 13 4	AWS A5.9	ER410NiMo (mod.)	3.2
Avesta 307-Si	EN ISO 14343-A	G 18 8 Mn	-	ER307 (mod.)	3.2
BÖHLER A 7-IG / A 7 CN-IG	EN ISO 14343-A	G 18 8 Mn	AWS A5.9	ER307 (mod.)	3.2
Thermanit X	EN ISO 14343-A	G 18 8 Mn	AWS A5.9	ER307 (mod.)	3.2
Avesta 316L-Si/SKR-Si	EN ISO 14343-A	G 19 12 3 L Si	AWS A5.9	ER316LSi	3.2
BÖHLER EAS 4 M-IG (Si)	EN ISO 14343-A	G 19 12 3 L Si	AWS A5.9	ER316LSi	3.2
Thermanit GE-316L Si	EN ISO 14343-A	G 19 12 3 L Si	AWS A5.9	ER316LSi	3.2
Avesta 318-Si/SKNb-Si	EN ISO 14343-A	G 19 12 3 Nb Si	-	-	3.2
Thermanit A Si	EN ISO 14343-A	G 19 12 3 Nb Si	AWS A5.9	ER318 (mod.)	3.2
Thermanit ATS 4	EN ISO 14343-A	G 19 9 H	AWS A5.9	ER19-10H	3.1
Avesta 308L-Si/MVR-Si	EN ISO 14343-A	G 19 9 L Si	AWS A5.9	ER308LSi	3.2
BÖHLER EAS 2-IG (Si)	EN ISO 14343-A	G 19 9 L Si	AWS A5.9	ER308LSi	3.2
Thermanit JE-308L Si	EN ISO 14343-A	G 19 9 L Si	AWS A5.9	ER308LSi	3.2
BÖHLER SAS 2-IG (Si)	EN ISO 14343-A	G 19 9 Nb Si	AWS A5.9	ER347Si	3.2
Thermanit H Si	EN ISO 14343-A	G 19 9 Nb Si	AWS A5.9	ER347Si	3.2
BÖHLER FF-IG	EN ISO 14343-A	G 22 12 H	AWS A5.9	ER309 (mod.)	3.2
Thermanit D	EN ISO 14343-A	G 22 12 H	AWS A5.9	ER309 (mod.)	3.2
Avesta 2205	EN ISO 14343-A	G 22 9 3 N L	AWS A5.9	ER2209	3.2
Thermanit 22/09	EN ISO 14343-A	G 22 9 3 N L	AWS A5.9	ER2209	3.2
BÖHLER CN 22/9 N-IG	EN ISO 14343-A	G 22 9 3 NL	AWS A5.9	ER2209	3.2
Avesta P5	EN ISO 14343-A	G 23 12 2 L	-	-	3.2
BÖHLER CN 23/12-IG	EN ISO 14343-A	G 23 12 L	AWS A5.9	ER309L	3.2
Avesta 309L-Si	EN ISO 14343-A	G 23 12 L Si	AWS A5.9	ER309LSi	3.2
Thermanit 25/14 E-309L Si	EN ISO 14343-A	G 23 12 L Si	AWS A5.9	ER309LSi	3.2
Avesta LDX 2101	EN ISO 14343-A	G 23 7 N L	-	-	3.2
BÖHLER FFB-IG	EN ISO 14343-A	G 25 20 Mn	AWS A5.9	ER310 (mod.)	3.2
BÖHLER FA-IG	EN ISO 14343-A	G 25 4	-	-	3.2



# Table of Contents (EN ISO) *cont.*

Product Name	EN/ISO-Standard	EN/ISO-Classification	AWS-Stand-ard	AWS-Classification	Chapter
Thermanit L	EN ISO 14343-A	G 25 4	-	-	3.2
Avesta 2507/P100	EN ISO 14343-A	G 25 9 4 N L	-	-	3.2
Thermanit 25/09 CuT	EN ISO 14343-A	G 25 9 4 N L	AWS A5.9	ER2594	3.2
Union K 52	EN ISO 14341-A	G 42 2 C1 3Si1 / G 46 4 M21 3Si1	AWS A5.18	ER70S-6	3.1
BÖHLER EMK 6	EN ISO 14341-A	G 42 4 M21 3Si1 / G 42 4 C1 3Si1	AWS A5.18	ER70S-6	3.1
BÖHLER NiCu 1-IG	EN ISO 14341-A	G 42 4 M21 Z3Ni1Cu / G 42 4 C1 Z3Ni1Cu	AWS A5.28	ER80S-G	3.1
BÖHLER SG 8-P	EN ISO 14341-A	G 42 5 M21 3Ni1	AWS A5.28	ER80S-G	3.1
Union K NOVA Ni	EN ISO 14341-A	G 42 5 M21 3Ni1	AWS A5.28	ER80S-G [ER80S-Ni1(mod.)]	3.1
Union K 56	EN ISO 14341-A	G 46 2 C G4Si1 / G 46 4 M G4Si1	-	ER70S-6	3.1
BÖHLER EMK 8	EN ISO 14341-A	G 46 4 M21 4Si1 / G 46 4 C1 4Si1	AWS A5.18	ER70S-6	3.1
BÖHLER 2,5 Ni-IG	EN ISO 14341-A	G 46 8 M21 2Ni2	AWS A5.28	ER80S-Ni2	3.1
Union K 5 Ni	EN ISO 14341-A	G 50 5 M21 3Ni1/G 46 3 C1 3Ni1	AWS A5.28	ER80S-G	3.1
Union K 52 Ni	EN ISO 14341-A	G 50 6 M21 Z3Ni1/G 46 4 C1 Z3Ni1	AWS A5.28	ER80S-G [ER80S-Ni1(mod.)]	3.1
Union Ni 2,5	EN ISO 14341-A	G 50 7 M21 2Ni2	AWS A5.28	ER80S-Ni2	3.1
BÖHLER NiMo 1-IG	EN ISO 16834-A	G 55 6 M21 Mn3Ni1Mo / G 55 4 C1 Mn3Ni1Mo	AWS A5.28	ER90S-G	3.1
Union MoNi	EN ISO 16834-A	G 62 5 M21 Mn3Ni1Mo	AWS A5.28	ER90S-G	3.1
BÖHLER X 70-IG	EN ISO 16834-A	G 69 5 M21 Mn3Ni1CrMo	AWS A5.28	ER110S-G	3.1
BÖHLER NiCrMo 2,5-IG	EN ISO 16834-A	G 69 6 M21 Mn3Ni2,5CrMo / G 69 4 C1 Mn3Ni2,5CrMo	AWS A5.28	ER110S-G	3.1
Union NiMoCr	EN ISO 16834-A	G 69 6 M21 Mn4Ni1,5CrMo	AWS A5.28	ER100S-G	3.1
Union X 85	EN ISO 16834-A	G 79 5 M21 Mn4Ni1,5CrMo	AWS A5.28	ER110S-G	3.1
Union X 96	EN ISO 16834-A	G 89 5 M21 Mn4Ni2,5CrMo	AWS A5.28	ER120S-G	3.1
BÖHLER X 90-IG	EN ISO 16834-A	G 89 6 M21 Mn4Ni2CrMo	AWS A5.28	ER120S-G	3.1
Union X 90	EN ISO 16834-A	G 89 6 M21 Mn4Ni2CrMo	AWS A5.28	ER120S-G	3.1
BÖHLER DCMS-IG	EN ISO 21952-A	G CrMo1Si	AWS A5.28	ER80S-G [ER80S-B2 (mod.)]	3.1
Union 1 CrMo	EN ISO 21952-A	G CrMo1Si	AWS A5.28	ER80S-G [ER80S-B2 (mod.)]	3.1
BÖHLER CM 2-IG	EN ISO 21952-A	G CrMo2Si	AWS A5.28	ER90S-B3 (mod.)	3.1
Union 1 CrMo 910	EN ISO 21952-A	G CrMo2Si	AWS A5.28	ER90S-G	3.1
BÖHLER C 9 MV-IG	EN ISO 21952-A	G CrMo91	AWS A5.28	ER90S-B9	3.1
Thermanit MTS 3	EN ISO 21952-A	G CrMo91	AWS A5.28	ER90S-B9	3.1
BÖHLER DMO-IG	EN ISO 21952-A	G MoSi	AWS A5.28	ER70S-A1	3.1
Union 1 Mo	EN ISO 21952-A	G MoSi	AWS A5.28	ER80S-G(A1)	3.1
Thermanit 17/15 TT	EN ISO 14343-A	G Z 17 15 Mn W	-	-	3.2
BÖHLER SKWAM-IG	EN ISO 14343-A	G Z 17 Mo	-	-	3.2
BÖHLER CAT 430L Co-IG	EN ISO 14343-A	G Z 18 L Nb	AWS A5.9	ER430 (mod.)	3.2
Thermanit 439 Ti	EN ISO 14343-A	G Z 18 Ti L	AWS A5.9	ER439 (mod.)	3.2
UTP A 2133 Mn	EN ISO 14343-A	G Z 21 33 Mn Nb	-	-	3.2
UTP A 2535 Nb	EN ISO 14343-A	G Z 25 35 Zr	-	-	3.2
UTP A 3545 Nb	EN ISO 14343-A	G Z 35 45 Nb	-	-	3.2
BÖHLER CAT 430L CoTi-IG	EN ISO 14343-A	G Z Cr 18 NbTi L	AWS A5.9	ER430Nb (mod.)	3.2
BÖHLER ASN 5-IG (Si)	EN ISO 14343-A	G Z 18 16 5 N L	AWS A5.9	ER317L (mod.)	3.2
Thermanit MTS 616	EN ISO 21952-A	GZ CrMoWVNb 9 0,5 1,5	AWS A5.28	ER90S-G [ER90S-B9(mod.)]	3.1
BÖHLER DMO	EN 12536	O IV	AWS A5.2	R60-G	2.1
BÖHLER CN 13/4-UP	EN ISO 14343-A	S 13 4	AWS A5.9	ER410NiMo (mod.)	4.2
BÖHLER A 7 CN-UP + BB 203	EN ISO 14343-A	S 18 8 Mn	AWS A5.9	ER307 (mod.)	4.2
Thermanit X	EN ISO 14343-A	S 18 8 Mn	AWS A5.9	ER307(mod.)	4.2
Avesta 316L/SKR	EN ISO 14343-A	S 19 12 3 L	AWS A5.9	ER316L	4.2
BÖHLER EAS 4 M-UP + BB 202	EN ISO 14343-A	S 19 12 3 L	AWS A5.9	ER316L	4.2

# Table of Contents (EN ISO) *cont.*

Product Name	EN/ISO-Standard	EN/ISO-Classification	AWS-Stand- ard	AWS-Classification	Chapter
Thermanit GE-316L	EN ISO 14343-A	S 19 12 3 L	AWS A5.9	ER316L	4.2
Thermanit A	EN ISO 14343-A	S 19 12 3 Nb	AWS A5.9	ER318	4.2
Avesta 308L/MVR	EN ISO 14343-A	S 19 9 L	AWS A5.9	ER308L	4.2
Thermanit JE-308L	EN ISO 14343-A	S 19 9 L	AWS A5.9	ER308L	4.2
Thermanit H-347	EN ISO 14343-A	S 19 9 Nb	AWS A5.9	ER347	4.2
Avesta 2205	EN ISO 14343-A	S 22 9 3 N L	AWS A5.9	ER2209	4.2
Thermanit 22/09	EN ISO 14343-A	S 22 9 3 N L	AWS A5.4	ER2209	4.2
Avesta P5	EN ISO 14343-A	S 23 12 2 L	-	ER309L(Mo(mod.))	4.2
Avesta 309L	EN ISO 14343-A	S 23 12 L	AWS A5.9	ER309L	4.2
Thermanit 25/14 E-309L	EN ISO 14343-A	S 23 12 L	AWS A5.9	ER309L	4.2
Avesta LDX 2101	EN ISO 14343-A	S 23 7 N L	-	-	4.2
Avesta 2507/P100	EN ISO 14343-A	S 25 9 4 N L	AWS A5.9	ER2594	4.2
BÖHLER EMS 2 + BB 24	EN ISO 14171-A	S 38 6 FB S2	AWS A5.17	F7A8-EM12K (F6P6-EM12K)	4.1
BÖHLER EMS 2 Mo + BB 24	EN ISO 14171-A	S 46 4 FB S2Mo	AWS A5.23	F8A4-EA2-A2/F8P0-EA2-A2	4.1
BÖHLER Ni 2-UP + BB 24	EN ISO 14171-A	S 46 6 FB S2Ni2	AWS A5.23	F8A8-ENi2-Ni2	4.1
BÖHLER 3 NiMo 1-UP + BB 24	EN ISO 26304-A	S 55 4 FB S3Ni1Mo	AWS A5.23	F9A4-EF3-F3	4.1
BÖHLER 3 NiCrMo 2,5-UP + BB 24	EN ISO 26304-A	S 69 6 FB S3Ni2,5CrMo	AWS A5.23	F11A8-EM4 (mod. J-M4H4)	4.1
Union S 2 CrMo	EN ISO 24598-A	S CrMo1	AWS A5.23	EB2R	4.1
Union S 1 CrMo 2	EN ISO 24598-A	S CrMo2	AWS A5.23	EB3R	4.1
Thermanit MTS 3	EN ISO 24598-A	S CrMo91	AWS A5.28	EB9	4.1
UTP A 80 M	EN ISO 18274	S Ni 4060 (NiCu30Mn3Ti)	AWS A5.14	ERNiCu-7	2.2
UTP A 80 M	EN ISO 18274	S Ni 4060 (NiCu30Mn3Ti)	AWS A5.14	ERNiCu-7	3.2
Thermanit NiMo C 24	EN ISO 18274	S Ni 6059 (NiCr23Mo16)	AWS A5.14	ERNiCrMo-13	2.2
Thermanit NiMo C 24	EN ISO 18274	S Ni 6059 (NiCr23Mo16)	AWS A5.14	ERNiCrMo-13	3.2
UTP A 759	EN ISO 18274	S Ni 6059 (NiCr23Mo16)	AWS A5.14	ER NiCrMo-13	2.2
UTP A 759	EN ISO 18274	S Ni 6059 (NiCr23Mo16)	AWS A5.14	ER NiCrMo-13	3.2
BÖHLER NiBAS 70/20-IG	EN ISO 18274	S Ni 6082 (NiCr20Mn3Nb)	AWS A5.14	ERNiCr-3	2.2
BÖHLER NiBAS 70/20-IG	EN ISO 18274	S Ni 6082 (NiCr20Mn3Nb)	AWS A5.14	ERNiCr-3	3.2
Thermanit Nicro 82	EN ISO 18274	S Ni 6082 (NiCr20Mn3Nb)	AWS A5.14	ERNiCr-3	2.2
Thermanit Nicro 82	EN ISO 18274	S Ni 6082 (NiCr20Mn3Nb)	AWS A5.14	ERNiCr-3	3.2
Thermanit NicrO 82	EN ISO 18274	S Ni 6082 (NiCr20Mn3Nb)	AWS A5.14	ERNiCr-3	4.2
UTP A 068 HH	EN ISO 18274	S Ni 6082 (NiCr20Mn3Nb)	AWS A5.14	ERNiCr-3	2.2
UTP A 068 HH	EN ISO 18274	S Ni 6082 (NiCr20Mn3Nb)	AWS A5.14	ERNiCr-3	3.2
Thermanit NiMo C 276	EN ISO 18274	S Ni 6276 (NiCr15Mo-16Fe6W4)	AWS A5.14	ERNiCrMo-4	4.2
UTP A 776	EN ISO 18274	S Ni 6276 (NiCr15Mo-16Fe6W4)	AWS A5.14	ERNiCrMo-4	2.2
UTP A 776	EN ISO 18274	S Ni 6276 (NiCr15Mo-16Fe6W4)	AWS A5.14	ERNiCrMo-4	3.2
Thermanit 617	EN ISO 18274	S Ni 6617 (NiCr22Co12Mo9)	AWS A5.14	ERNiCrCoMo-1	2.2
Thermanit 617	EN ISO 18274	S Ni 6617 (NiCr22Co12Mo9)	AWS A5.14	ERNiCrCoMo-1	3.2
UTP A 6170 Co	EN ISO 18274	S Ni 6617 (NiCr22Co12Mo9)	AWS A5.14	ERNiCrCoMo-1	2.2
UTP A 6170 Co	EN ISO 18274	S Ni 6617 (NiCr22Co12Mo9)	AWS A5.14	ERNiCrCoMo-1	3.2
Avesta P12	EN ISO 18274	S Ni 6625 (NiCr22Mo9Nb)	AWS A5.14	ERNiCrMo-3	2.2
Avesta P12	EN ISO 18274	S Ni 6625 (NiCr22Mo9Nb)	AWS A5.14	ERNiCrMo-3	3.2
Avesta P12	EN ISO 18274	S Ni 6625 (NiCr22Mo9Nb)	AWS A5.14	ERNiCrMo-3	4.2
BÖHLER NiBAS 625-IG	EN ISO 18274	S Ni 6625 (NiCr22Mo9Nb)	AWS A5.14	ERNiCrMo-3	2.2
BÖHLER NiBAS 625-IG	EN ISO 18274	S Ni 6625 (NiCr22Mo9Nb)	AWS A5.14	ERNiCrMo-3	3.2
Thermanit 625	EN ISO 18274	S Ni 6625 (NiCr22Mo9Nb)	AWS A5.14	ERNiCrMo-3	2.2
Thermanit 625	EN ISO 18274	S Ni 6625 (NiCr22Mo9Nb)	AWS A5.14	ERNiCrMo-3	3.2
Thermanit 625	EN ISO 18274	S Ni 6625 (NiCr22Mo9Nb)	AWS A5.14	ERNiCrMo-3	4.2
UTP A 6222 Mo	EN ISO 18274	S Ni 6625 (NiCr22Mo9Nb)	AWS A5.14	ER NiCrMo-3	2.2
UTP A 6222 Mo	EN ISO 18274	S Ni 6625 (NiCr22Mo9Nb)	AWS A5.14	ERNiCrMo-3	3.2
UTP UP 6222 Mo	EN ISO 18274	S Ni 6625 (NiCr22Mo9Nb)	AWS A5.14	ERNiCrMo-3	4.2

# Table of Contents (EN ISO) *cont.*

Product Name	EN/ISO-Standard	EN/ISO-Classification	AWS-Stand- ard	AWS-Classification	Chapter
Thermanit 35/45 Nb	EN ISO 18274	S Ni Z (NiCr36Fe15Nb0,8)	-	-	2.2
Thermanit 35/45 Nb	EN ISO 18274	S Ni Z (NiCr36Fe15Nb0,8)	-	-	3.2
BÖHLER EMS 2 CrMo + BB 24	EN ISO 24598-A	S S CrMo1 FB	AWS A5.23	F8P2-EB2-B2	4.1
BÖHLER CM 2-UP + BB 418 TT	EN ISO 24598-A	S S CrMo2 FB	AWS A5.23	F8P2-EB3-B3	4.1
BÖHLER C 9 MV-UP + BB 910	EN ISO 24598-A	S S CrMo91 FB	AWS A5.23	EB9	4.1
Union S P 24	EN ISO 24598-A	S Z CrMo2VNb	AWS A5.23	EG	4.1
Union S 1 CrMo 2 V	EN ISO 24598-A	S ZCrMoV2	AWS A5.23	EG	4.1
Thermanit MTS 616	EN ISO 24598-A	S ZCrMoWVNb 9 0,5 1,5	AWS A5.23	EG [EB9(mod.)]	4.1
Union S 2	EN ISO 14171-A	S2	AWS A5.17	EM12	4.1
Union S 2 Mo	EN ISO 24598-A	S2Mo	AWS A5.23	EA2	4.1
Union S 2 Ni 2,5	EN ISO 14171-A	S2Ni2	AWS A5.23	ENi2	4.1
Union S 2 Ni 3,5	EN ISO 14171-A	S2Ni3	AWS A5.23	ENi3	4.1
Union S 2 Si	EN ISO 14171-A	S2Si	AWS A5.17	EM12K	4.1
Union S 3	EN ISO 14171-A	S3	AWS A5.17	EH10K	4.1
Union S 3 Mo	EN ISO 24598-A	S3Mo	AWS A5.23	E44	4.1
Union S 3 NiMo	EN ISO 14171-A	S3Ni1,5Mo	AWS A5.23	EG [EF1 (mod.)]	4.1
Union S 3 NiMo 1	EN ISO 14171-A	S3Ni1Mo	AWS A5.23	EF3	4.1
Union S 3 Si	EN ISO 14171-A	S3Si	AWS A5.17	EH12K	4.1
UV 310 P	EN ISO 14174	SAAB 1 55 AC H5	-	-	4.3
UV 309 P	EN ISO 14174	SAAB 1 65 AC H5	-	-	4.3
BÖHLER BB 400	EN ISO 14174	SAAB 1 67 AC H5	-	-	4.3
UV 400	EN ISO 14174	SAAB 1 67 AC H5	-	-	4.3
Avesta FLUX 805	EN ISO 14174	SA AF 2 Cr DC	-	-	4.3
UV 305	EN ISO 14174	SAAR 1 76 AC H5	-	-	4.3
UV 306	EN ISO 14174	SAAR 1 77 AC H5	-	-	4.3
Avesta FLUX 801	EN ISO 14174	SA CS 2 Cr DC	-	-	4.3
BÖHLER BB 418 TT	EN ISO 14174	SA FB 1 55 AC H5	-	-	4.3
UV 418 TT	EN ISO 14174	SA FB 1 55 AC H5	-	-	4.3
UV 421 TT	EN ISO 14174	SA FB 1 55 AC H5	-	-	4.3
UV 420 TTR-W	EN ISO 14174	SA FB 1 65 AC	-	-	4.3
UV 420 TTR-C	EN ISO 14174	SA FB 1 65 DC	-	-	4.3
UV 420 TTR	EN ISO 14174	SA FB 1 65 DC / SA FB 1 65 AC	-	-	4.3
UV 420 TT	EN ISO 14174	SA FB 1 65 DC / SA FB 1 65 DC H5	-	-	4.3
BÖHLER BB 24	EN ISO 14174	SA FB 1 65 DC H5	-	-	4.3
Marathon 543	EN ISO 14174	SA FB 2 65 DC H5	-	-	4.3
Marathon 431	EN ISO 14174	SA FB 2 64 DC	-	-	4.3
BÖHLER BB 202	EN ISO 14174	SA FB 2 DC	-	-	4.3
BÖHLER BB 910	EN ISO 14174	SA FB 2 DC H5	-	-	4.3
Union S 2 NiMo 1	EN ISO 14171-A	SZ2Ni1Mo	AWS A5.23	ENi1	4.1
Union S 3 NiMoCr	EN ISO 26304-A	SZ3Ni2,5CrMo	AWS A5.23	EG [EF6 (mod.)]	4.1
BÖHLER CN 13/4-MC	EN ISO 17633-A	T 13 4 M M 2	AWS A5.9	EC410NiMo (mod.)	5.2
BÖHLER A 7-MC	EN ISO 17633-A	T 18 8 Mn M M 1	AWS A5.9	EC307 (mod.)	5.2
BÖHLER A7 FD	EN ISO 17633-A	T 18 8 Mn R M(C) 3	AWS A5.22	E307T0-G	5.2
Avesta FCW 316L/SKR-PW	EN ISO 17633-A	T 19 12 3 L P M/C1	AWS A5.22	E316LT1-4 ; E316LT1-1	5.2
BÖHLER EAS 4 PW-FD	EN ISO 17633-A	T 19 12 3 L P M/C1	AWS A5.22	E316LT1-4 ; E316LT1-1	5.2
BÖHLER EAS 4 M-FD	EN ISO 17633-A	T 19 12 3 L R M(C) 3	AWS A5.22	E316LT0-4 ; E316LT0-1	5.2
Thermanit TG 316 L	EN ISO 17633-A	T 19 12 3 L R M(C) 3	AWS A5.22	E316LT0-4 ; E316LT0-1	5.2
Avesta FCW-2D 316L/SKR	EN ISO 17633-A	T 19 12 3 L R M/C3	AWS A5.22	E316LT0-4 ; E316LT0-1	5.2
BÖHLER EAS 2 PW-FD	EN ISO 17633-A	T 19 9 L P M(C) 1	AWS A5.22	E308LT1-4 ; E308LT1-1	5.2
Avesta FCW 308L/MVR-PW	EN ISO 17633-A	T 19 9 L P M/C 1	AWS A5.22	E308LT1-4 ; E308LT1-1	5.2
BÖHLER EAS 2-FD	EN ISO 17633-A	T 19 9 L R M(C) 3	AWS A5.22	E308LT0-4 ; E308LT0-1	5.2
Avesta FCW-2D 308L/MVR	EN ISO 17633-A	T 19 9 L R M/C 3	AWS A5.22	E308LT0-4 ; E308LT0-1	5.2

# Table of Contents (EN ISO) *cont.*

Product Name	EN/ISO-Standard	EN/ISO-Classification	AWS-Stand- ard	AWS-Classification	Chapter
Thermanit TG 308 L	EN ISO 17633-A	T 19 9 L R M/C3	AWS A5.22	E308LT0-4 ; E308LT0-1	5.2
BÖHLER SAS 2 PW-FD	EN ISO 17633-A	T 19 9 Nb P M(C) 1	AWS A5.22	E347T1-4 ; E347T1-1	5.2
BÖHLER SAS 2-FD	EN ISO 17633-A	T 19 9 Nb R M(C) 3	AWS A5.22	E347T0-4 ; E347T0-1	5.2
Avesta FCW-2D 347/IMNb	EN ISO 17633-A	T 19 9 Nb R M/C3	AWS A5.22	E347T0-4 ; E347T0-1	5.2
Avesta FCW 2205-PW	EN ISO 17633-A	T 22 9 3 N L P M(C) 1	AWS A5.22	E2209T1-4 ; E2209T1-1	5.2
BÖHLER CN 22/9 PW-FD	EN ISO 17633-A	T 22 9 3 NL P M(C) 1	AWS A5.22	E2209T1-4 ; E2209T1-1	5.2
Avesta FCW-2D 2205	EN ISO 17633-A	T 22 9 3 NL R M/C3	AWS A5.22	E2209T0-4 ; E2209T0-1	5.2
BÖHLER CN 23/12 Mo PW-FD	EN ISO 17633-A	T 23 12 2 L P M(C) 1	AWS A5.22	E309LMoT1-4 ; E309LMoT1-1	5.2
BÖHLER CN 23/12 Mo-FD	EN ISO 17633-A	T 23 12 2 L R M(C) 3	AWS A5.22	E309LMoT0-4 ; E309LMoT0-1	5.2
Avesta FCW-2D P5	EN ISO 17633-A	T 23 12 2 L R M/C3	AWS A5.22	E309LMoT0-4 ; E309LMoT0-1	5.2
Avesta FCW 309L-PW	EN ISO 17633-A	T 23 12 L P M/C1	AWS A5.22	E309LT1-4 ; E309LT1-1	5.2
BÖHLER CN 23/12 PW-FD	EN ISO 17633-A	T 23 12 L P M/C1	AWS A5.22	E309LT1-4 ; E309LT1-1	5.2
BÖHLER CN 23/12-FD	EN ISO 17633-A	T 23 12 L R M(C) 3	AWS A5.22	E309LT0-1 ; E309LT0-4	5.2
Thermanit TG 309 L	EN ISO 17633-A	T 23 12 L R M(C) 3	AWS A5.22	E309LT0-4 ; E309LT0-1	5.2
Avesta FCW-2D 309L	EN ISO 17633-A	T 23 12 L R M/C 3	AWS A5.22	E309LT0-4 ; E309LT0-1	5.2
Avesta FCW 2507/P100-PW	EN ISO 17633-A	T 25 9 4 N L P M21 (C) 2	AWS A5.22	E2594T1-4 ; E2594T1-1	5.2
BÖHLER TI 52-FD	EN ISO 17632-A	T 46 4 P M 1 H10 / T 42 2 P C 1 H5	AWS A5.20	E71T1-M21A4-CS1-H8; E71T1-C1A2-CS1-H4	5.1
Union TG 55 M	EN ISO 17632-A	T 46 4 P M 1 H10 / T 42 2 P C 1 H5	AWS A5.20	E71T-1MJH8 / E71T-1CH8	5.1
BÖHLER TI 60-FD	EN ISO 17632-A	T 50 6 1Ni P M 1 H5	AWS A5.29	E81T1-M21A8-Ni1-H4	5.1
BÖHLER TI 70 PIPE-FD	EN 18276-A	T 55 4 Mn1Ni P M 1H5	AWS A5.29	E91T1-M21A4-G	5.1
BÖHLER DCM5 TI-FD	EN ISO 17634-A	T 0m1 P M 1 H10	AWS A5.29	E81T1-M21PY-B2H8	5.1
BÖHLER DMO TI-FD	EN ISO 17634-A	T MoL P M 1 H10	AWS A5.29	E81T1-M21PY-A1H8	5.1
BÖHLER NIBAS 70/20-FD	EN ISO 12153	T Ni 6082 R M 3	AWS A5.34	ENiCr3T0-4	5.2
UTP AF 068 HH	EN ISO 12153	T Ni 6082 R M 3	AWS A5.34	ENiCr3T0-4	5.2
Avesta FCW P12-PW	EN ISO 12153	T Ni 6625 P M 2	AWS A5.34	ENiCrMo3T1-4	5.2
BÖHLER NIBAS 625 PW-FD	EN ISO 12153	T Ni 6625 P M 2	AWS A5.34	ENiCrMo3T1-4	5.2
UTP AF 6222 MoPW	EN ISO 12153	T Ni 6625 P M 2	AWS A5.34	ENiCrMo3T1-4	5.2
Avesta FCW LDX 2101-PW	EN ISO 17633-A	T 2 24 9 N L P M(C) 1	AWS A5.22	E2307T1-4 ; E2307T1-1	5.2
Avesta FCW-2D LDX 2101	EN ISO 17633-A	T 2 24 9 N L R M(C) 3	AWS A5.22	E2307T0-4 ; E2307T0-1	5.2
BÖHLER EAS 4 PW-FD (LF)	EN ISO 17633-A	T 19 12 3 L P M/C1	AWS A5.22	E316LT1-4 ; E316LT1-1	5.2
BÖHLER CN 13/4-IG	EN ISO 14343-A	W 13 4	AWS A5.9	ER410NiMo (mod.)	2.2
BÖHLER A 7 CN-IG	EN ISO 14343-A	W 18 8 Mn	AWS A5.9	ER307 (mod.)	2.2
Thermanit X	EN ISO 14343-A	W 18 8 Mn	AWS A5.9	ER307 (mod.)	2.2
Avesta 316L/SKR	EN ISO 14343-A	W 19 12 3 L	AWS A5.9	ER316L	2.2
BÖHLER EAS 4 M-IG	EN ISO 14343-A	W 19 12 3 L	AWS A5.9	ER316L	2.2
Thermanit GE-316L	EN ISO 14343-A	W 19 12 3 L	AWS A5.9	ER316L	2.2
Avesta 316L-Si/SKR-Si	EN ISO 14343-A	W 19 12 3 L Si	AWS A5.9	ER316LSi	2.2
Thermanit GE-316L Si	EN ISO 14343-A	W 19 12 3 L Si	AWS A5.9	ER316LSi	2.2
BÖHLER SAS 4-IG	EN ISO 14343-A	W 19 12 3 Nb	AWS A5.9	ER318	2.2
Thermanit A	EN ISO 14343-A	W 19 12 3 Nb	AWS A5.9	ER318	2.2
Avesta 318-Si/SKNb-Si	EN ISO 14343-A	W 19 12 3 Nb Si	AWS A5.9	ER318(mod.)	2.2
Thermanit ATS 4	EN ISO 14343-A	W 19 9 H	AWS A5.4	ER19-10H	2.1
Avesta 308L/MVR	EN ISO 14343-A	W 19 9 L	AWS A5.9	ER308L	2.2
Thermanit JE-308L	EN ISO 14343-A	W 19 9 L	AWS A5.9	ER308L	2.2
Avesta 308L-Si/MVR-Si	EN ISO 14343-A	W 19 9 L Si	AWS A5.9	ER308LSi	2.2
Thermanit JE-308L Si	EN ISO 14343-A	W 19 9 L Si	AWS A5.9	ER308LSi	2.2
BÖHLER SAS 2-IG	EN ISO 14343-A	W 19 9 Nb	AWS A5.9	ER347	2.2
Thermanit H-347	EN ISO 14343-A	W 19 9 Nb	AWS A5.9	ER347	2.2
BÖHLER FF-IG	EN ISO 14343-A	W 22 12 H	AWS A5.9	ER309 (mod.)	2.2
Thermanit D	EN ISO 14343-A	W 22 12 H	AWS A5.9	ER309 (mod.)	2.2
Avesta 2205	EN ISO 14343-A	W 22 9 3 N L	AWS A5.9	ER2209	2.2
BÖHLER CN 22/9 N-IG	EN ISO 14343-A	W 22 9 3 N L	AWS A5.9	ER2209	2.2

## Table of Contents (EN ISO) *cont.*

Product Name	EN/ISO-Standard	EN/ISO-Classification	AWS-Stan- dard	AWS-Classification	Chapter
Thermanit 22/09	EN ISO 14343-A	W 22 9 3 N L	AWS A5.9	ER2209	2.2
Avesta P5	EN ISO 14343-A	W 23 12 2 L	AWS A5.09	ER309L.Mo(mod.)	2.2
BÖHLER CN 23/12-IG	EN ISO 14343-A	W 23 12 L	AWS A5.9	ER309L	2.2
Thermanit 25/14 E-309L	EN ISO 14343-A	W 23 12 L	AWS A5.9	ER309L	2.2
Avesta 309L-Si	EN ISO 14343-A	W 23 12 L Si	AWS A5.9	ER309LSi	2.2
Avesta LDX 2101	EN ISO 14343-A	W 23 7 N L	-	-	2.2
BÖHLER FFB-IG	EN ISO 14343-A	W 25 20 Mn	AWS A5.9	ER310 (mod.)	2.2
BÖHLER FA-IG	EN ISO 14343-A	W 25 4	-	-	2.2
Thermanit L	EN ISO 14343-A	W 25 4	-	-	2.2
Avesta 2507/P100	EN ISO 14343-A	W 25 9 4 N L	AWS A5.9	ER2594	2.2
BÖHLER CN 25/9 CuT-IG	EN ISO 14343-A	W 25 9 4 N L	AWS A5.9	ER2594	2.2
Thermanit 25i/09 CuT	EN ISO 14343-A	W 25 9 4 N L	AWS A5.9	ER2594	2.2
BÖHLER EMK 6	EN ISO 636-A	W 42 5 W3Si1	AWS A5.18	ER70S-6	2.1
Union I 52	EN ISO 636-A	W 42 5 W3Si1	AWS A5.18	ER70S-6	2.1
Union I Mo	EN ISO 636-A	W 46 3 W2Mo	AWS A5.28	ER80S-G(A1)	2.1
BÖHLER EML 5	EN ISO 636-A	W 46 5 W2Si	AWS A5.18	ER70S-3	2.1
BÖHLER 2,5 Ni-IG	EN ISO 636-A	W 46 8 W2Ni2	AWS A5.28	ER80S-Ni2	2.1
BÖHLER DCMS-IG	EN ISO 21952-A	W CrMo1Si	AWS A5.28	ER80S-B2 (mod.)	2.1
Union I CrMo	EN ISO 21952-A	W CrMo1Si	AWS A5.28	ER80S-G	2.1
BÖHLER CM 2-IG	EN ISO 21952-A	W CrMo2Si	AWS A5.28	ER90S-B3 (mod.)	2.1
Union I CrMo 910	EN ISO 21952-A	W CrMo2Si	AWS A5.28	ER90S-G	2.1
BÖHLER C 9 MV-IG	EN ISO 21952-A	W CrMo91	AWS A5.28	ER90S-B9	2.1
Thermanit MTS 3	EN ISO 21952-A	W CrMo91	AWS A5.28	ER90S-B9	2.1
BÖHLER DMO-IG	EN ISO 636-A	W MoSi	AWS A5.28	ER70S-A1	2.1
UTP A 2133 Mn	EN ISO 14343-A	W Z 21 33 Mn Nb	-	-	2.2
UTP A 2535 Nb	EN ISO 14343-A	W Z 25 35 Zr	-	-	2.2
UTP A 3545 Nb	EN ISO 14343-A	W Z 35 45 Nb	-	-	2.2
Union I P24	EN ISO 21952-A	W Z CrMo2VTiNb	AWS A5.28	ER90S-G	2.1
Thermanit MTS 616	EN ISO 21952-A	W Z CrMoWV Nb 9 0,5 1,5	AWS A5.28	ER90S-G [ER90S-B9(mod.)]	2.1
BÖHLER Ni 1-IG	EN ISO 636-A	W3Ni1	AWS A5.28	ER80S-Ni1 (mod.)	2.1

### Overview

Between the publication of the last version of this manual and the present, up-to-date version, a range of standards that previously were exclusively European and national have been replaced by EN-ISO standards. This section provides a summary of the new standards that are now considered in the product information and provides references to national standards that are affected. This section also provides information on the forms of delivery in which you can obtain various welding consumables, along with notes on proper storage of the welding consumables.

### Welding consumables standard according to European standards

#### Summary of EN / EN ISO standards for welding consumables

Standard	Title of the standard
EN ISO 636	Rods, wires and deposits for tungsten inert gas welding of non-alloy and fine-grain steels.
EN ISO 2560	Covered electrodes for manual metal arc welding of non-alloy and fine grain steels.
EN ISO 3580	Covered electrodes for manual metal arc welding of creep-resisting steels.
EN ISO 3581 <i>replaces EN 1600</i>	Covered electrodes for manual metal arc welding of stainless and heat-resisting steels.
EN ISO 12153	Tubular cored electrodes for gas shielded and non-gas shielded metal arc welding of nickel and nickel alloys.
EN 12536	Rods for gas welding of non alloy and creep-resisting steels.
EN ISO 14171 <i>replaces EN 756</i>	Solid wire electrodes, tubular cored electrodes and electrode/flux combinations for submerged arc welding of non alloy and fine grain steels.
EN ISO 14172	Covered electrodes for manual metal arc welding of nickel and nickel alloys.
EN ISO 14174 <i>replaces EN 760</i>	Fluxes for submerged arc welding and electroslag welding.
EN ISO 14175	Gases and gas mixtures for fusion welding and allied processes
EN ISO 14341	Wire electrodes and weld deposits for gas shielded metal arc welding of non alloy and fine grain steels.
EN ISO 14343	Wire electrodes, strip electrodes, wires and rods for arc welding of stainless and heat resisting steels.
EN ISO 16834 steels.	Wire electrodes, wires, rods and deposits for gas shielded arc welding of high strength
EN ISO 17632	Tubular cored electrodes for gas shielded and non-gas shielded metal arc welding of non-alloy and fine grain steels.
EN ISO 17633	Tubular cored electrodes and rods for gas shielded and non-gas shielded metal arc welding of stainless and heat-resisting steels.
EN ISO 17634	Tubular cored electrodes for gas shielded metal arc welding of creep-resisting steels.
EN ISO 18274	Solid wire electrodes, solid strip electrodes, solid wires and solid rods for fusion welding of nickel and nickel alloys.
EN ISO 18275 <i>replaces EN 757</i>	Covered electrodes for manual metal arc welding of high-strength steels.
EN ISO 18276	Tubular cored electrodes for gas-shielded and non-gas-shielded metal arc welding of high-strength steels.
EN ISO 21952	Wire electrodes, wires, rods and deposits for gas shielded arc welding of creep-resisting steels.
EN ISO 24034	Solid wire electrodes, solid wires and rods for fusion welding of titanium and titanium alloys.
EN ISO 24373	Solid wires and rods for fusion welding of copper and copper alloys.
EN ISO 24598	Solid wire electrodes, tubular cored electrodes and electrode-flux combinations for submerged arc welding of creep-resisting steels.
EN ISO 26304	Solid wire electrodes, tubular cored electrodes and electrode-flux combinations for submerged arc welding of high strength steels.

The European standards quoted above have been or are being adopted by national standards institutes, and their content is therefore identical to that of the national standards.

## I. General information

### Examples of the classification system using various welding consumables

Classification system according to **EN ISO 18275-A** using a **FOX EV 70 Mo** as an example

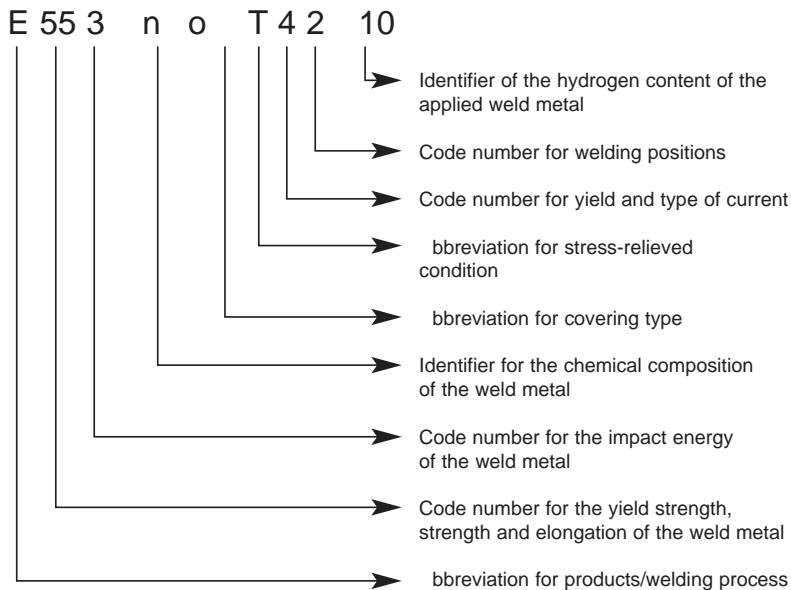

Classification system according to **EN ISO 14341-A** taking an **EMK 8** as an example

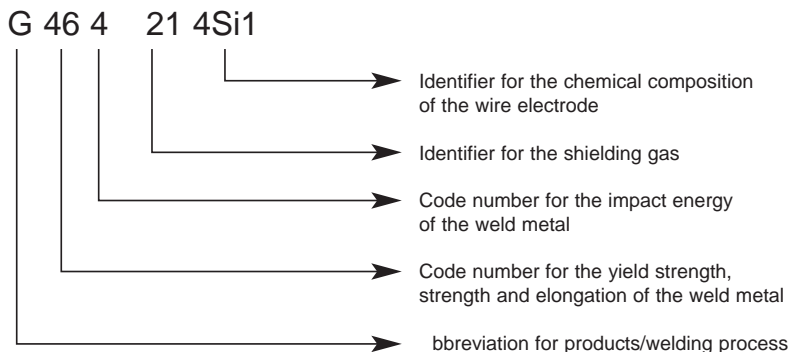



## I. General information

Classification system according to **EN ISO 3581-A** using a **FOX EAS 4 M** as an example

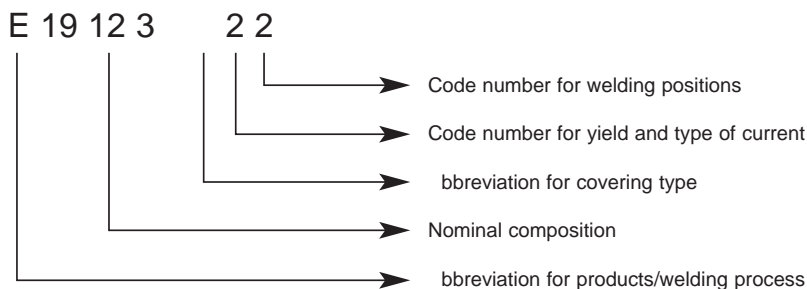

Classification system according to **EN ISO 17 32-A** taking a **i 52-F** as an example

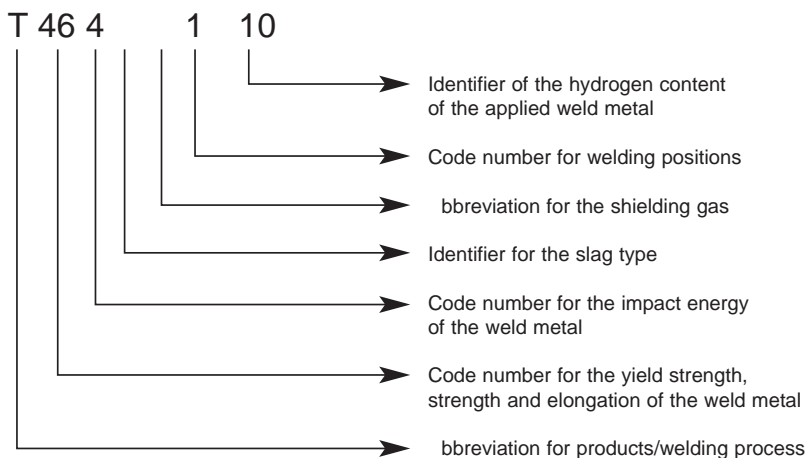

## I. General information

### Abbreviations code numbers for welding consumables classification A in EN ISO standards

#### Abbreviation for welding process product

Abbreviation	Description	EN ISO standards concerned
E	Manual metal arc welding	2560, 3580, 3581, 14172, 18275
G	Gas shielded metal arc welding with solid wire electrodes	14341, 14343, 21952, 16834
W	Tungsten inert gas welding	636, 14343, 16834, 21952
T	Gas shielded metal arc welding with flux cored wires	12153, 17632, 17633, 17634, 18276
S S/T	Submerged arc welding solid/flux cored wire	14171, 14343, 24598, 26304
O	Gas welding	12536
	Plasma welding	14341
S or	Solid wire / stick or solid strip	14343, 18274

#### Code number for the yield strength strength and elongation of the weld metal

Code number	$R_{eH}$ (MPa)	$R_m$ (MPa)	$A_5$ (%)	EN ISO standards concerned
35	355	440-570	22	636, 2560, 14341, 14171, 17632
38	380	470-600	20	
42	420	500-640	20	
46	460	530-680	20	
50	500	560-720	18	
55	550	610-780	18	16834, 18275, 18276, 26304
62	620	690-890	18	
69	690	760-960	17	
79	790	880-1080	16	
89	890	980-1180	15	

#### Code number for yield strength and strength with single-run two-run welding

Code number	Yield strength of the weld metal $R_{eH}$ (MPa)	Tensile strength of the weld metal $R_m$ (MPa)	EN ISO standards concerned
2T	275	370	14171
3T	355	470	14171, 17632
4T	420	520	
5T	500	600	

#### Identifier for impact energy

Code number	Temperature for impact energy $T_{KV}$ (°C)	EN ISO standards concerned
	No requirement	636, 2560, 14341, 14171, 16384, 18275, 18276, 26304
	20	
0	0	
2	-20	
3	-30	
4	-40	
5	-50	
6	-60	
7	-70	
8	-80	
10	-100	14171, 18275, 18276
		14171

## I. General information

Abbreviation for stress-relieved condition		
Abbreviation	description	EN ISO standards concerned
T	mechanical properties after annealing 560-600 C / 1h / furnace up to 300 C / air	16834, 18275 26304
	mechanical properties in the welded condition	all
Code number for yield and type of current		
code number	yield	type of current
1	≤ 105	alternating and direct current
2	≤ 105	direct current
3	>105 ≤ 125	alternating and direct current
4	>105 ≤ 125	direct current
5	>125 ≤ 160	alternating and direct current
6	>125 ≤ 160	direct current
7	160	alternating and direct current
8	160	direct current
		2560, 3580, 3581, 18275  2560, 3581, 18275
Code number for welding positions		
Identifier	description	EN ISO standards concerned
1	All positions	2560, 3580, 3581, 12153, 18275, 17632, 17633, 17634, 18276
2	All positions except for vertical down	
3	butt weld in flat position, fillet weld in flat and horizontal positions	
4	butt weld in flat position, fillet weld in flat position	
5	vertical down position, and positions as in code number 3	
Code number of hydrogen content in the weld-metal		
code number	Maximum hydrogen content ml 100g weld metal	EN ISO standards concerned
5	5	2560, 3580, 14171,
10	10	17632, 17634, 18275,
15	15	18276, 26304
Abbreviation for shielding gases		
Abbreviation	Shielding gas type	EN ISO standards concerned
	Shielding gas EN ISO 14175- 2, but without helium	17632, 17634, 18276
C	Shielding gas EN ISO 14175-C1, carbon dioxide	
e.g. 21	The abbreviation for the shielding gas must be accordance with EN ISO 14175	12153, 14341, 16834, 17633
	No shielding gas specified	14341, 16834, 17633
N	No shielding gas	17632, 18276
NO	No shielding gas	12153, 17633

## I. General information

Abbreviation for covering type		
Abbreviation	covering type	EN ISO standards concerned
	acid covering	2560
C	cellulosic covering	
R	rutile covering	2560, 3580, 3581
RR	rutile thick covering	2560
RC	rutile-cellulosic covering	
R	rutile-acid covering	
R	rutile-basic covering	
	basic covering	2560, 3580, 3581, 18275
Abbreviation for flux type		
Abbreviation	Flux type main	EN ISO standards concerned
	aluminate basic	14174, 14171, 18274, 26304, 24598
S	aluminate-silicate	
F	aluminate-fluoride basic	
R	aluminate-rutile	
	basic-aluminate	
CG	calcium-magnesium	
CS	calcium-silicate	
F	fluoride basic	
S	manganese-silicate	
RS	rutile-silicate	
S	irconium-silicate	
	any other composition	
Identifier for the type of core		
code	number	EN ISO standards concerned
	<b>type and properties</b>	<b>concerned</b>
R	Rutile, slowly solidifying slag, shielding gas required	12153, 17632, 17633, 17634, 18276
	Rutile, fast solidifying slag, shielding gas required	
	asic, shielding gas required	
	etal powder, shielding gas required	
	Rutile or basic/fluoride, shielding gas not required	17632
W	asic/fluoride, slowly solidifying slag, shielding gas not required	
	asic/fluoride, fast solidifying slag, shielding gas not required	
	Other types	12153, 17632, 17633, 17634, 18276
	Without shielding gas, self-shielding	12153, 17633
list of the abbreviations for the chemical composition has been omitted from this manual.		

## I. Storage guidelines and redrying

### Storing stick electrodes

Covered electrodes should always be stored in their original packaging until they are used. Electrode packages should, as far as possible, be removed on first-in first out basis.

Stick electrodes must be stored in dry rooms in order to protect them from moisture damage. The storage area should therefore be protected against the weather and ventilated. Ceilings, floors and walls must be dry, and there must be no open water surfaces in the room. The room must be fitted with pallets or with shelving, since storage directly on the floor or against the walls is not recommended.

Electrode packages that have been opened must be stored in dry rooms, which may have to be heated to avoid falling below the dew point.

### Redrying and processing electrodes

It is recommended that any electrodes that have become damp or that have not been properly stored are redried according to the temperatures given in the following table immediately before welding. Following this it is in any case recommended to weld from a quiver heated to 100-150 C in order to be able to maintain the lowest possible hydrogen content.

Stick electrodes for ...	Covering type	Redrying recommended	Redrying temperature in C	Redrying time in hours
alloyed and low-alloy steels	R, C, RC, RR, RR, R	No	--	--
		Yes	300 350	2 10
High-strength fine-grained structural steels		Yes	300 350	2 10
Creep-resistant steels	R	No	--	--
	R, C	Yes	300 350	2 10
Stainless and heat-resistant steels	R	If necessary	120 200	2 10
	R, C	No	--	--
Soft martensitic steels		Yes	300 350	2 10
Duplex steels	R	Yes	250 300	2 10
Nickel alloys	R, C	If necessary	120 300	2 10

The redrying temperature is also quoted on the labels of the electrode packages.

The following procedure is helpful for redrying electrodes

- The electrodes should be placed in a pre-heated furnace approx. 80 - 100 C. Layers should not be more than three.
- Once heated up, the recommended temperature should be maintained for about 2 hours. If the redrying temperature is above 250 C, the temperature should be raised to the recommended value slowly approx. 150 C/hour.
- Total redrying time i.e. the total of the times of individual redrying procedures of more than 10 hours should not be exceeded. This maximum time must also be observed if the redrying is carried out in a number of cycles.
- The temperature should be lowered to between 100 and 150 C before removing from the furnace.

Electrodes that have been in direct contact with water, grease or oil should not be used. In such cases, even redrying does not provide an adequate solution.

Covered electrodes that are delivered in undamaged boxes or in vacuum packaging do not require redrying if they are put immediately into a heated quiver and used from there.

Electrodes from damaged boxes or vacuum packaging must be treated according to the specifications.

## I. Storage guidelines and redrying

Stick electrodes for which redrying is not recommended in the table above may, in some individual cases, still benefit from redrying. This can be the case if storage was inappropriate, or as a result of other conditions that lead to an excessive water content. The high water content can often be recognised from increased spraying or pore formation during welding. In these cases, the stick electrodes can unless otherwise specified by the manufacturer be redried for about one hour at 100 - 120 C. This recommendation does not apply to cellulose-covered electrodes, which must never be redried.

The temperature for intermediate storage in a furnace after redrying should be between 120 and 200 C maximum total storage time 30 days, or, if stored in quivers, between 100 and 200 C maximum storage time 10 days.

### Storage of flux cored wires

The risk of moisture absorption is not as great with flux cored wires as it is for stick electrodes. The core is shielded from the ambient atmosphere to a large extent by the metal surround. Nevertheless, the low-hydrogen character of a flux cored wire can be impaired by long contact with moist air. This can, for instance, happen through unprotected storage overnight in a high-humidity environment.

Flux cored wire should be kept in storage facilities where the temperature and humidity conditions are controlled. We recommend the use of dry rooms, possibly heated, to avoid falling below the dew point. The aim should be a maximum 60 relative air humidity and a minimum temperature of 15 C.

If stored below 10 C there is a risk that water will condense on the surface of the wire when the package is opened in heated rooms. This can lead to pore and gas impressions on the welded seam when welding starts.

Welding should only be done with acclimatised wires.

When welding has finished, the spool with the remaining wire should be removed from the machine and placed back in the original packaging the compound aluminium foil should be closed again as far as possible. It is also possible to use a box such as is used for deliveries of filler welding flux for high-alloy steels.

37

### redrying flux cored wires

Redrying is not required as a rule. If, in some exceptional case, redrying is needed, this can be done at 150 C for 24h.

### Storage and redrying of welding flux

It is recommended that welding flux is stored in the driest possible conditions and at the most even possible temperature, in order to keep water absorption during storage as low as possible. Under these conditions, fluxes can generally be kept for up to three years. Flux from containers that have been damaged during transport must either be used immediately or put into new packaging. In order to ensure crack-free welding, fluoride-basic fluxes should be redried prior to use. Fluxes that are taken directly from airtight, sealed, undamaged metal sheet containers do not have to be redried.

Type of flux manufacture	Flux type	Redrying recommended	Redrying temperature in C	Redrying time in hours
agglomerated	F	es	ca. 350	2 - 10
	R	es	ca. 300	2 - 10
elted	S	es	ca. 150	2 - 500

The drying temperatures and times given in the above table should be considered as a general guideline. After redrying, welding flux that is not being used immediately is to be stored at 150 C until used for welding. The intermediate storage period should not exceed 30 days.

The furnace used for the redrying must not permit any local overheating of the flux, and must be adequately ventilated. If drying is stationary, the flux layer should not be thicker than 50 mm.

## I. Certificates of conformity and other certificates

### General notes

If wanted, factory certificates or acceptance test certificates according to EN 10204 can be prepared for each delivery. Test Reports according to WS 5.01 can also be supplied. Whatever the type of certification, it must always be requested at the time of order.

It is essential that the extent of testing is stated for EN 10204-3.1 acceptance test certificates and for Test Reports. The subsequent preparation of a 3.1 Certificate or a Test Report with a testing scope that differs from schedules F and is always associated with increased administration and increased costs. If a production series has already been entirely processed, it is not possible to prepare retrospective certificates.

### Factory certificates according to EN 10204-2 2

These certificates are product-specific, which means that a separate certificate is prepared for every series or batch number. All those values that are gathered during the course of operational testing and that are relevant to the certificate are entered onto the certificate. This means that all the actual values obtained during ongoing quality testing of all low, medium and high-alloy stick electrodes and flux cored wires for their chemical composition are entered, whereas only statistical values based on non-specific testing are entered for unalloyed electrodes and flux cored wires in some cases.

The melt analyses of the associated batches are given on the factory certificates of all solid wires and sticks.

Mechanical grades are shown on the factory certificates of all products with the exception of S W wires and flux. The quoted values are guaranteed tolerance limits minimum and/or maximum, depending on the requirements of the standard, and correspond to the minimum properties for the product guaranteed in this manual.

### Acceptance test certificates according to EN 10204-3 1 and 3 2

3.1 or 3.2 acceptance test certificates are also prepared if required. For this purpose, tests must be carried out on the delivery or on the manufacturing unit associated with the delivery. Since this involves certification of a delivery-specific test according to the requirements of the customer, it is essential that the extent of testing is made known at the time of the order, or at the initial enquiry stage. The resulting costs will be charged according to expenditure.

### Test reports according to AWS A5.01

If certification of conformity of the product with the WS American Welding Society is required for a customer project, a Test Report should be requested. The Test Report contains, as standard, a confirmation of conformity for correspondence with the applicable WS standard, or with the reference to this WS standard contained in SE II, art C. If no further elements are specified by the customer, the Test Report corresponds to Schedule F of the WS 5.01. The content of this Test Report is comparable to that of a 2.2 factory certificate.

The necessary testing scope must be made known at the time of order for all other schedules. In this case, charging will be according to expenditure.

## I. Product information

Information about the materials is amongst the most important prerequisites for choosing the right welding consumables. The limited scope of this manual does not permit every relevant property to be given, but at least an overview is given of the valid EN designations, and of the obsolescent or still valid DIN designations, as well as of the chemical composition of all the materials that have been standardised through materials numbers within Europe.



## II. General notes on the data section

The product information on the following pages is maintained consistently for all the welding consumables from Böhler Welding. For the sake of easier orientation, the header of each data page carries information on the subchapter, the product form and/or a colour coding.

Each product is identified by its trade name and by a product group. The product description contains some changes from the last issue of the manual. Amongst other things, the classification according to standards has been thoroughly adapted to the current issues (at the time of going to press) of the EN ISO, EN and AWS standards.

The conversion has also been applied to the information about the base materials. The "Properties" section of each data page gives a brief characterisation of the welding consumable. It describes the type of covering or alloy, the range of application, the welding behaviour, areas of use and general information about temperature control and/or subsequent heat treatment.

The "**Reference analysis**" gives the chemical composition of the pure weld metal for stick electrodes and flux cored wires, and for other product forms it gives the composition of the wire, stick or flux. For wire/flux combinations, the reference analysis of the wire and that of the weld metal is given.

The information about minimum values or ranges of chemical composition and of the mechanical grade of the weld metal are specified primarily in the light of the requirements in the standards. In contrast, the guide values are based on the evaluations of our permanent statistical quality control, and are only for information. In both cases, the latest state of the art at the time of going to press is taken into account.

The "**processing instructions**" represent an extension over previous issues of the manual.

The symbols for the welding position and the electrical polarity accord with the labelling on the product packaging. In addition, you will find information on the stamping or embossing of products, and instructions for redrying.

Information on **products with identical or similar alloys** has also been added. This should make it easier for you to select a welding consumable if you want to change the welding procedure while using the same base material.

### Explanation of symbols and abbreviations

No.	EN/ IN material number
EN	European standard or the national standard derived from it
EN ISO	International standard based on the EN standard
WS	American Welding Society
IN	German industrial standard

#### Welding positions

PD	PE	PF	PG	PA	PC	PB	w	1G, 1F	downhand/flat position
					C		h	2F	horizontal position
							q	2G	horizontal vertical position
					E		h	4F	horizontal overhead position
								4G	overhead position
					F		s	3G, 3F, 5G up	vertical position up
					G		f	3G, 3F, 5G down	vertical position down

dotted arrow	----->	limited weldability in this welding position
bold arrow	—————>	especially designed for welding in this position

#### Type of current and polarity

<b>==+</b>	direct current positive polarity
<b>==-</b>	direct current negative polarity
<b>~</b>	alternating current

Combinations are possible, e.g.

<b>==±</b>	direct current positive or negative polarity or alternating current
------------	---

#### Mechanical Property Values

yield strength $R_{eL}$	independent from the base material the term yield strength covers the upper or lower elastic limit $R_{eL}$ , $R_{eH}$ or the proof stress in the case of non-proportional elongation $R_{p0.2}$ .
Impact work ISO-	the test results shown in this handbook are measured using test specimen with ISO-V-notch.

#### Approvals and inspecting authorities

S	American Bureau of Shipping
	Bureau Veritas
CE	CE mark
CRS	Croatian Register of Shipping
CW	Canadian Welding Bureau
	German Railways Deutsche Bahn
	Det Norske Veritas
N	Germanischer Lloyd
G	T approval T safety standard 1408.1 Germany
T 1408.1	
R	Lloyd's Register of Shipping

## II. General notes on the data section

### Approvals and inspecting authorities

LTSS	= Lithuanian Technical Supervision Service
NAKS	= Nationalna Assoziacija Kontrol i Svarka
R.I.NA	= Registro Italiano Navale
RS	= Maritime Register of Shipping, Russia
SEPROZ	= Approval Society, Ukraine
Statoil	= Statoil, Norway
Gazprom	= Russian energy company
TUV-D	= Technical Inspection Association (Technischer Überwachungsverein), Germany
TUV-A	= Technical Inspection Association (Technischer Überwachungsverein), Austria
VG 95132	= Approval list for armour steel
WIWEB	= Bundeswehr Research Institute for Materials, Explosives, Fuels and Lubricants (Wehrwissenschaftliches Institut für Werk- und Betriebsstoffe)

### Remark:

Details for approvals regarding base materials, classifications, welding positions, etc. can be found in the approval certificates – please contact the service departments for detailed information.

### Shielding gases according to EN ISO 14175

short designation		components in vol.-%					
group	no.	oxidising		inert		de-oxidising	slow reaction
		CO <sub>2</sub>	O <sub>2</sub>	Ar	He	H <sub>2</sub>	N <sub>2</sub>
I	1			100			
	2				100		
	3			bal.	0,5 ≤ He ≤ 95		
M1	1	0,5 ≤ CO ≤ 5				0,5 ≤ H ≤ 5	
	2	0,5 ≤ CO ≤ 5					
	3		0,5 ≤ O <sub>2</sub> ≤ 3				
M2	4	0,5 ≤ CO ≤ 5	0,5 ≤ O <sub>2</sub> ≤ 3				
	0	5 ≤ CO ≤ 15					
	1	15 ≤ CO ≤ 25					
	2		3 ≤ O <sub>2</sub> ≤ 10				
	3	0,5 ≤ CO ≤ 5	3 ≤ O <sub>2</sub> ≤ 10				
	4	5 ≤ CO ≤ 15	0,5 ≤ O <sub>2</sub> ≤ 3				
M3	5	5 ≤ CO ≤ 15	3 ≤ O <sub>2</sub> ≤ 10				
	6	15 ≤ CO ≤ 25	0,5 ≤ O <sub>2</sub> ≤ 3				
	7	15 ≤ CO ≤ 25	3 ≤ O <sub>2</sub> ≤ 10				
	1	25 ≤ CO ≤ 50					
	2		10 ≤ O <sub>2</sub> ≤ 15				
	3	25 ≤ CO ≤ 50	2 ≤ O <sub>2</sub> ≤ 10				
	4	5 ≤ CO ≤ 25	10 ≤ O <sub>2</sub> ≤ 15				
5	25 ≤ CO ≤ 50	10 ≤ O <sub>2</sub> ≤ 15					
C	1	100					
	2	bal.	0,5 ≤ O <sub>2</sub> ≤ 30				
R	1			bal. <sup>a</sup>		0,5 ≤ H ≤ 15	
	2			bal. <sup>a</sup>		15 ≤ H ≤ 50	
N	1						100
	2			bal. <sup>a</sup>			0,5 ≤ N ≤ 5
	3			bal. <sup>a</sup>			5 ≤ N ≤ 50
	4			bal. <sup>a</sup>		0,5 ≤ H ≤ 10	0,5 ≤ N ≤ 5
	5					0,5 ≤ H ≤ 50	bal.
O	1		100				
Z	Mixture gases with components which are not listed in this table or mixture gases with a composition which is not in the stated range <sup>b</sup>						
<sup>a</sup> For this classification you can substitute Argon particulate or complete by Helium <sup>b</sup> Two mixture gases with the same Z designation should not be exchanged against each other							

**Remark:** This handbook references standardised shielding gases just in these cases where best welding result can be expected. If the shielding gas class shows too wide ranges the handbook recommends the optimum gas composition. The standardised shielding gas can be applicable but will produce different welding behaviour and/or other mechanical property values.

## Chapter 1.1 - Stick electrodes (unalloyed, low-alloyed)

Product name	EN ISO	AWS	Page
BOHLER FOX KE	E 38 0 RC 11	E6013	2
BOHLER FOX OHV	E 38 0 RC 11	E6013	3
Phoenix SH Gelb R	E 38 2 RB 12	E6013	4
Phoenix Blau	E 42 0 RC 11	E6013	5
BOHLER FOX ETI	E 42 0 RR 12	E6013	6
Phoenix Grün T	E 42 0 RR 12	E6013	7
BOHLER FOX EV 47	E 38 4 B 42 H5	E7016-1H4R	8
BOHLER FOX EV 50-A	E 42 3 B 12 H10	E7016	9
Phoenix SPEZIAL D	E 42 3 B 12 H10	E 7016	10
UTP COMET J 50 N	E 42 3 B 12 H 10	E 7016	11
BOHLER FOX EV 50	E 42 5 B 42 H5	E7018-1H4R	12
Phoenix 120 K	E 42 5 B 32 H5	E7018-1	13
BOHLER FOX CEL	E 38 3 C 21	E6010	14
BOHLER FOX CEL+	E 38 2 C 21	E6010	15
Phoenix Cel 70	E 42 2 C 25	E6010	16
Phoenix Cel 75	E 42 2 C 25	E7010-P1	17
BOHLER FOX CEL 75	E 42 3 C 25	E7010-P1	18
BOHLER FOX CEL Mo	E 42 3 Mo C 25	E7010-A1	19
Phoenix Cel 80	E 46 3 C 25	E8010-P1	20
BOHLER FOX CEL 85	E 46 4 1Ni C 25	E8010-P1	21
BOHLER FOX CEL 90	E 50 3 1Ni C 25	E9010-P1	22
Phoenix Cel 90	E 50 3 1Ni C 25	E9010-G	23
BOHLER FOX EV PIPE	E 42 4 B 12 H5	E7016-1H4R	24
BOHLER FOX BVD 85	E 46 5 1Ni B 45	E8045-P2	25
BOHLER FOX BVD 90	E 55 5 Z2Ni B 45	E9045-P2 (mod.)	26
BOHLER FOX BVD 100	E 62 5 Z2Ni B 45	E10045-P2 (mod.)	27
BOHLER FOX EV 60	E 46 6 1Ni B 42 H5	E8018-C3H4R	28
Phoenix SH Schwarz 3 K	E 50 4 Mo B 42	E7015-G	29
Phoenix SH Schwarz 3 K Ni	E 50 4 1NiMo B 42 H5	E9018-G	30
BOHLER FOX EV 65	E 55 6 1NiMo B 42 H5	E8018-GH4R	31
Phoenix SH Ni 2 K 100	E 69 5 Mn2NiCrMo B 42 H5	E11018-G	32
BOHLER FOX EV 85	E 69 6 Mn2NiCrMo B 42 H5	E11018-GH4R	33
BOHLER FOX DMO Kb	E Mo B 4 2 H5	E7018-A1H4R	34
Phoenix SH Schwarz 3 MK	E Mo B 42 H5	E7018-A1	35
BOHLER FOX DCMS Kb	E CrMo1 B 4 2 H5	E8018-B2H4R	36
Phoenix Chromo 1	E CrMo 1 B 42 H5	E8018-B2	37
Phoenix SH Chromo 2 KS	E CrMo 2 B 42 H5	E9015-B3	38
Phoenix SH Kupfer 3 KC	E ZCrMoV 1 B 42 H5	E9015-G	39
BOHLER FOX C 9 MV	E CrMo91 B 4 2 H5	E9015-B9	40
BOHLER FOX P 92	E ZCrMoWVNb 9 0,5 2 B 4 2 H5	E9015-B9 (mod.)	41
Thermanit MTS 616	E ZCrMoWVNb 9 0,5 2 B 4 2 H5	E9015-G	42
Thermanit Chromo 9 V	E CrMo 91 B 42 H5	E9015-B9	43
Thermanit MTS 3	E CrMo 91 B 42 H5	E9015-B9	44
BOHLER FOX CM 2 Kb	E CrMo2 B 4 2 H5	E9018-B3H4R	45
BOHLER FOX CM 5 Kb	E CrMo5 B 4 2 H5	E8018-B6H4R	46
BOHLER FOX CM 9 Kb	E CrMo9 B 4 2 H5	E8018-B8	47
BOHLER FOX 20 MWV	E CrMoWV 12 B 4 2 H5	-	48
Avesta 308/308H AC/DC	E 19 9 R	E308H-17	49
BOHLER FOX E 308 H	E 19 9 H R 4 2	E308H-16	50
Thermanit ATS 4	E 19 9 H B 22	E308H-15	51
BOHLER FOX 2,5 Ni	E 46 8 2Ni B 42 H5	E8018-C1H4R	52

## Classifications

unalloyed rutile

EN ISO 2560-A:

AWS A5.1:

E 38 0 RC 11

E6013

## Characteristics and field of use

Rutile cellulose coated stick electrode with comfortable weldability in all positions, including vertical down to some extent. Exceptional weldability with AC, good ignition and re-ignition properties, reliable fusion penetration, flat seam. Preferred for building fitters and assembly jobs.

## Base materials

Steels up to a yield strength of 380 MPa (52 Ksi)  
 S235JR-S355JR, S235JO-S355JO, P195TR1-P265TR1, P195GH-P265GH,  
 L245NB-L360NB, L245MB-L360MB, shipbuilding steels: A, B, D  
 ASTM A 106, Gr. A, B; A 283 Gr. A, C; A 285 Gr. A, B, C; A 501, Gr. B; A 573, Gr. 58, 65;  
 A 633, Gr. A, C; A 711 Gr. 1013; API 5 L Gr. B, X42, X52

## Typical analysis of all-weld metal (Wt-%)

C	Si	Mn		
0,06	0,3	0,5		

## Mechanical properties of all-weld metal

Heat Treatment	Yield strength 0,2%	Tensile strength	Elongation ( $L_0=5d_0$ )	Impact values in J CVN		
				+20°C:	±0°C:	-10°C:
untreated	430	490	26	75	65	50

## Operating data



Polarity = - / ~

## Dimensions (mm)

## Amperage A

2,0 x 250	45-80
2,5 x 250/350	60-100
3,2 x 350	90-130
4,0 x 350/450	110-170

## Approvals and certificates

LR (2m), SEPROZ

**Classifications**

unalloyed rutile

EN ISO 2560-A:

AWS A5.1:

E 38 0 RC 11

E6013

**Characteristics and field of use**

Rutile cellulose coated stick electrode with very good weldability in all positions, including vertical down.

Universal electrode, particularly for small transformers. Bendable covering. Versatile application in steel, vehicle, boiler, container and ship construction, as well as for galvanised components.

**Base materials**

Steels up to a yield strength of 380 MPa (52 ksi)  
 S235JR-S355JR, S235JO-S355JO, P195TR1-P265TR1, P195GH-P265GH, L245NBL360NB, L245MB-L360MB, shipbuilding steels: A, B, D  
 ASTM A 106, Gr. A, B; A 283 Gr. A, C; A 285 Gr. A, B, C; A 501, Gr. B; A 573, Gr. 58, 65;  
 A 633, Gr. A, C; A 711 Gr. 1013; API 5 L Gr. B, X42, X52

**Typical analysis of all-weld metal (Wt-%)**

C	Si	Mn		
0,06	0,4	0,5		

**Mechanical properties of all-weld metal**

Heat Treatment	Yield strength 0,2%	Tensile strength	Elongation ( $L_0=5d_0$ )	Impact values in J CVN		
				+20°C:	±0°C:	-10°C:
untreated	MPa 460	MPa 490	% 25	75	60	47

**Operating data**



Polarity = - / -

Dimensions (mm)	Amperage A
2,0 x 250	45-80
2,5 x 250/350	60-100
3,2 x 350	90-130
4,0 x 350/450	110-170
5,0 x 450	170-240

**Approvals and certificates**

TÜV-D (5687.), DB (10.014.12), ABS (2), DNV (2), LR (2), LTSS, SEPROZ, CE

## Phoenix Sh Gelb R

Stick electrode

## Classifications

unalloyed rutile

EN ISO 2560-A:

AWS A5.1:

E 38 2 RB 12

E6013

## Characteristics and field of use

Rutile basic electrode. Excellent vertical up welding characteristics; easy handling in out of position work; particularly suitable for fabricating radiographically sound circumferential pipe welds; good porosity-free root weld fusion, also in tight air gaps. Useable in pipeline, boiler and tank construction, structural steel work and shipbuilding.

## Base materials

S235JRG2 - S355J2; shipbuilding steels appr.-grade 3; boiler steels P235GH, P265GH, P295GH; ASTM A36 and A53 Gr. all; A106 Gr. A, B, C; A135 Gr. A, B; A283 Gr. A, B, C, D; A366; A285 Gr. A, B, C; A500 Gr. A, B, C; A570 Gr. 30, 33, 36, 40, 45; A607 Gr. 45; A668 Gr. A, B; A907 Gr. 30, 33, 36, 40; A935 Gr. 45; A936 Gr. 50; API 5 L Gr. B, X42-X52

## Typical analysis of all-weld metal (Wt-%)

C

Si

Mn

0,08

0,20

0,55

## Mechanical properties of all-weld metal

Heat Treatment

Yield strength  
0,2%

Tensile strength

Elongation  
( $L_0=5d_0$ )Impact values  
in J CVN

MPa

MPa

%

at room temperature

untreated

380

460

22

75

## Operating data



Polarity = - / ~

Dimensions (mm)

Amperage A

2,0 x 250

30- 75

2,5 x 250

40- 90

2,5 x 350

40- 90

3,2 x 350

90-130

4,0 x 350

140-190

4,0 x 450

140-190

5,0 x 450

190-250

## Approvals and certificates

TÜV (Certificate No. 01591) DB (Reg. form No. 10.132.20) ABS BV GL LR DNV

## Classifications

unalloyed rutile

EN ISO 2560-A:

AWS A5.1-04:

E 42 0 RC 11

E6013

## Characteristics and field of use

Rutile cellulose covered electrode. General purpose; useable in all positions; excellent gap-bridging and arc-striking ability; for tack-welding and bad fit-ups. Well suited for welding rusty and primed plates (roughly 40 µm); excellent vertical down characteristics. Useable on small transformers (42 V, open circuit).

## Base materials

S235JRG2 - S355J2; GS-38; GS-45; St35; St45; St35.8; boiler steels P235GH, P265GH, P295GH; shipbuilding steels corresp. to app.-grade 2; fine grained structural steels up to P355N; weldable ribbed reinforcing steel bars. ASTM A36 and A53 Gr. all; A106 Gr. A, B, C; A135 Gr. A, B; A283 Gr. A, B, C, D; A366; A285 Gr. A, B, C; A500 Gr. A, B, C; A570 Gr. 30, 33, 36, 40, 45; A607 Gr. 45; A668 Gr. A, B; A907 Gr. 30, 33, 36, 40; A935 Gr. 45; A936 Gr. 50; API 5 L Gr. B, X42-X52

## Typical analysis of all-weld metal (Wt-%)

C	Si	Mn		
0,09	0,35	0,50		

## Mechanical properties of all-weld metal

Heat Treatment	Yield strength 0,2%	Tensile strength	Elongation ( $L_0=5d_0$ )	Impact values
				in J CVN
	MPa	MPa	%	at room temperature
untreated	420	510	22	50

## Operating data



Polarity = - / -

Dimensions (mm)	Amperage A
2,0 x 250	30- 75
2,5 x 250	40- 90
2,5 x 350	40- 90
3,2 x 350	90-130
4,0 x 350	140-190
4,0 x 450	140-190
5,0 x 350	190-240
5,0 x 450	190-240

## Approvals and certificates

TÜV (Certificate No. 00425) DB (Reg. form No. 10.132.19) ABS BV LR GL (2Y) DNV



## Classifications

unalloyed rutile

EN ISO 2560-A:

AWS A5.1:

E 42 0 RR 12

E6013

## Characteristics and field of use

Rutile coated stick electrode with excellent weldability in all positions with the exception of vertical down. Particularly smooth seams, self-releasing slag. Little spatter, and good weldability with AC. Exceptional re-ignition properties and easy handling. High run-out lengths can be achieved. Versatile applicability in industry and craft.

## Base materials

Steels up to a yield strength of 420 MPa (60ksi) S235JR-S355JR, S235JO-S355JO, P195TR1-P265TR1, P195GH-P265GH, L245NB-L360NB, L245MB-L360MB, L415NB, L415MB, shipbuilding steels: A, B, D ASTM A 106, Gr. A, B; A 283 Gr. A, C; A 285 Gr. A, B, C; A 501, Gr. B; A 573, Gr. 58, 65, 70; A 633, Gr. A, C; A 711 Gr. 1013; API 5 L Gr. B, X42, X52, X60

## Typical analysis of all-weld metal (Wt-%)

C	Si	Mn		
0,07	0,4	0,5		

## Mechanical properties of all-weld metal

Heat Treatment	Yield strength 0,2%	Tensile strength	Elongation ( $L_0=5d_0$ )	Impact values in J CVN		
				MPa	MPa	%
untreated	430	520	26	65	50	

## Operating data



Polarity = - / ~

## Dimensions (mm)

## Amperage A

1,5 x 250	40-60
2,0 x 250	45-80
2,5 x 250/350	60-110
3,2 x 350/450	90-140
4,0 x 450	110-190
5,0 x 450	170-240

## Approvals and certificates

TÜV-D (1097.), ABS (2), BV (2), DNV (2), GL (2), LR (2m), LTSS, SEPPOZ, CE

## Classifications

unalloyed rutile

EN ISO 2560-A:

AWS A5.1:

E 42 0 RR 12

E6013

## Characteristics and field of use

Rutile covered electrode. Very little spatter, self releasing slag; finely rippled, smooth welds with notch-free weld metal / parent metal interface. Unproblematical welding of general-purpose structural steels; also suitable for vertical down welding in diam. up to 2.0 mm. Outstanding striking and restriking ability. For use on small transformers (42 V, open circuit).

## Base materials

S235JRG2 - S355J2; St 35; St 45; St 35.8; St 45.8; boiler steels P235GH, P265GH, P295GH; ship-building steels; fine grained structural steels up to P355N- and M-grades. ASTM A36 and A53 Gr. all; A106 Gr. A, B, C; A135 Gr. A, B; A283 Gr. A, B, C, D; A366; A285 Gr. A, B, C; A500 Gr. A, B, C; A570 Gr. 30, 33, 36, 40, 45; A607 Gr. 45; A668 Gr. A, B; A907 Gr. 30, 33, 36, 40; A935 Gr. 45; A936 Gr. 50; API 5 L Gr. B, X42-X56

## Typical analysis of all-weld metal (Wt-%)

C	Si	Mn		
0,08	0,35	0,55		

## Mechanical properties of all-weld metal

Heat Treatment	Yield strength 0,2%	Tensile strength	Elongation ( $L_0=5d_0$ )	Impact values
				in J CVN
	MPa	MPa	%	at room temperature
untreated	420	510	22	60

## Operating data

	Polarity = - / ~
---	------------------

Dimensions (mm)	Amperage A
2,0 x 250	45-65
2,0 x 350	45-65
2,5 x 250	60-100
2,5 x 350	60-100
3,2 x 350	85-140
3,2 x 450	85-140
4,0 x 350	130-200
4,0 x 450	130-200
5,0 x 450	230-300
6,0 x 450	280-370

## Approvals and certificates

TÜV (Certificate No. 00350), DB (Reg. form No. 10.132.58), ABS, BV, LR, GL, DNV

## Classifications

unalloyed basic

EN ISO 2560-A:

AWS A5.1:

E 38 4 B 42 H5

E7016-1H4R

## Characteristics and field of use

Basic coated stick electrode for high-quality welded joints. Good out-of-position welding except for vertical down. Deposition efficiency about 110%. Very low hydrogen content in the weld metal (under AWS conditions HD  $\leq$  4 ml/100g). The weld metal is particularly tough and resistant to cracking and ageing, therefore specially suitable for rigid components with large seam cross-sections.

## Base materials

Steels up to a yield strength of 380 MPa (52 ksi) S235JR-S355JR, S235JO-S355JO, S235J2-S355J2, S275N-S355N, S275M-S355M, P235GH-P355GH, P355N, P275NL1-P355NL1, P215NL, P265NL, P285NH-P355NH, P195TR1-P265TR1, P195TR2-P265TR2, P195GH-P265GH, L245NB-L360NB, L245MB-L360MB, GE200-GE240, shipbuilding steels: A, B, D, E, A 32-E 36 ASTM A 106 Gr. A, B, C; A 181 Gr. 60, 70; A 283 Gr. A, C; A 285 Gr. A, B, C; A 350 Gr. LF1, LF2; A 414 Gr. A, B, C, D, E, F, G; A 501 Gr. B; A 513 Gr. 1018; A 516 Gr. 55, 60, 65, 70; A 573 Gr. 58, 65, 70; A 588 Gr. A, B; A 633 Gr. A, C, D; A 662 Gr. A, B, C; A 678 Gr. A, B; A 711 Gr. 1013; API 5 L Gr. B, X42, X52, X56

## Typical analysis of all-weld metal (Wt-%)

C

Si

Mn

0,07

0,4

0,9

## Mechanical properties of all-weld metal

Heat Treatment	Yield strength 0,2%	Tensile strength	Elongation ( $L_0=5d_0$ )	Impact values in J CVN			
				+20°C:	-20°C:	-40°C:	-45°C:
untreated	440	530	27	190	110	90	

## Operating data



Polarity = +

## Dimensions (mm)

## Amperage A

2,5 x 250/350

80-110

3,2 x 350/450

100-140

4,0 x 435/450

130-180

5,0 x 450

180-230

## Approvals and certificates

TÜV-D (1098.), DB (10.014.09), ABS (3H5), BV (3HHH), DNV (3H10), GL (3H5), LR (3m H5), RMR (2), RINA (3YH5, 3H5), LTSS, SEPROZ, CE

## Classifications

unalloyed basic

EN ISO 2560-A:

AWS A5.1:

E 42 3 B 12 H10

E7016

## Characteristics and field of use

Basic double coated electrode in all positions, except for vertical down, exceptionally good welding. Thanks to its well-aligned arc, it is particularly suitable for out-of-position welding. Very good root welding. Well-suited to AC power. Low spatter, good slag detachability, even weld pattern. Also suitable for small transformers.

## Base materials

Steels up to a yield strength of 420 MPa (60 ksi) S235JR-S355JR, S235JO-S355JO, S235J2-S355J2, S275N-S420N, S275M-S420M, P235GH-P355GH, P355N, P285NH-P420NH, P195TR1-P265TR1, P195TR2-P265TR2, P195GH-P265GH, L245NB-L415NB, L245MB-L415MB, GE200-GE240 ASTM A 106 Gr. A, B, C; A 181 Gr. 60, 70; A 283 Gr. A, C; A 285 Gr. A, B, C; A 414 Gr. A, B, C, D, E, F, G; A 501 Gr. B; A 516 Gr. 55, 60, 65, 70; A 573 Gr. 58, 65, 70; A 588 Gr. A, B; A 633 Gr. A, C, D; A 662 Gr. A, B, C; A 678 Gr. A, B; A 711 Gr. 1013; API 5 L Gr. B, X42, X52, X56, X60

## Typical analysis of all-weld metal (Wt-%)

C	Si	Mn		
0,07	0,7	1,1		

## Mechanical properties of all-weld metal

Heat Treatment	Yield strength 0,2%	Tensile strength	Elongation ( $L_0=5d_0$ )	Impact values in J CVN	
				+20°C:	-30°C:
untreated	440	550	28	180	

## Operating data



Polarity = ± / ~

## Dimensions (mm)

## Amperage A

2,0 x 350	60-90
2,5 x 350/450	100-150
3,2 x 450	140-190
4,0 x 450	190-250

## Approvals and certificates

TÜV-D (10574.), DB (10.014.17), CE

## Phoenix Spezial D

Stick electrode

## Classifications

unalloyed basic

EN ISO 2560-A:

AWS A5.1:

E 42 3 B 12 H10

E7016

## Characteristics and field of use

Double covered basic electrode. Outstanding welding characteristics on AC and DC in all positions except the vertical down; stable arc, good radiographic soundness. Useable in handicraft and industry for field and workshop applications. Redry for 2 h at 250 - 300 °C (482 - 572 °F).

## Base materials

S235JRG2 - S355J2, boiler steels P235GH, P265GH, P295GH, P355GH; fine grained structural steels up to S355N; pipe steels St 35, St 35.8, L210 - L360NB, GS-52, L290MB - L360MB; ASTM A27 and A36 Gr. all, A214, A242 Gr. 1-5, A266 Gr. 1, 2, 4, A283 Gr. A, B, C, D, A285 Gr. A, B, C, A299 Gr. A, B, A328, A366, A515 Gr. 60, 65, 70, A516 Gr. 55, A570 Gr. 30, 33, 36, 40, 45, A572 Gr. 42, 50, A606 Gr. all, A607 Gr. 45, A656 Gr. 50, 60, A668 Gr. A, B, A907 Gr. 30, 33, 36, 40, A841, A851 Gr. 1, 2, A935 Gr. 45, A936 Gr. 50; API 5 L Gr. B, X42-X56

## Typical analysis of all-weld metal (Wt-%)

C	Si	Mn		
0,06	0,65	1,05		

## Mechanical properties of all-weld metal

Heat Treatment	Yield strength 0,2%	Tensile strength	Elongation ( $L_0=5d_0$ )	Impact values in J CVN	
				at RT	-30 °C
untreated	440	550	22	80	50

## Operating data



Polarity = + / -

## Dimensions (mm)

## Amperage A

2,5 x 350	60-90
3,2 x 350	95-150
3,2 x 450	95-150
4,0 x 450	140-190
5,0 x 450	190-250

## Approvals and certificates

TÜV (Certificate No. 03282), DB (Reg. form No. 10.132.42), ABS, BV, DNV, GL, LR

**Classifications**

unalloyed basic

EN ISO 2560-A:

AWS A5.1:

E 42 3 B 12 H10

E7016

**Characteristics and field of use**

The special coating technology of Comet J 50N provides a flat, regular and finely rippled bead surface, a stable arc, a good slag detachability and a notch-free wetting behaviour. The weld metal is not sensitive towards metal impurities. Thank to its double coating, this electrode is well applied for root-passes and welding out of position. Comet J 50 N can be welded in DC and AC, the weld efficiency amounts to 120%, H<sub>2</sub>-% in the weld deposit < 8 ml/100g.

**Base materials**

Unalloyed steels S235JRG2 – S355J2; E295, E335, St35, St 45, St 35.8, St45.8, St50-2  
 Pressure vessel construction steels P235GH, P265GH, P295GH Fine-grain steels till grade S355N  
 Shipping construction steels A – E, AH - EH Cast steels C 35, GS-38, GS-45

**Typical analysis of all-weld metal (Wt-%)**

C	Si	Mn		
0,06	0,7	1,1		

**Mechanical properties of all-weld metal**

Heat Treatment	Yield strength 0,2%	Tensile strength	Elongation (L <sub>0</sub> =5d <sub>0</sub> )	Impact values in J CVN
	MPa	MPa	%	at RT
untreated	420	510	22	140

**Operating data**

Polarity = + / -

**Dimensions (mm)****Amperage A**

2,5 x 350	50-100
3,2 x 450	70-130
4,0 x 450	110-170
5,0 x 450	140-220

**Approvals and certificates**

ABS, BV, DNV, FT, GL, LR, TÜV

## Classifications

unalloyed basic

EN ISO 2560-A:

AWS A5.1:

E 42 5 B 42 H5

E7018-1H4R

## Characteristics and field of use

Basic coated stick electrode for high-quality welded joints. Exceptional strength and toughness properties down to -50°C. Deposition efficiency about 110%. Good welding in all positions except for vertical down. Very low hydrogen content in the weld metal (under AWS conditions  $HD \leq 4$  ml/100g). The electrode is suitable for joint welding in steel, boiler, container, vehicle, ship and machine construction, and as a buffer layer for build-up welds with high-carbon steels. Suitable for welding steels of low purity and high carbon content. Particularly suitable for offshore constructions, CTOD-tested at -10°C. BÖHLER FOX EV 50 is also suitable for use in acid gas (HIC test according to NACE TM-02-84). Values for the SSC test are also available.

## Base materials

Steels up to a yield strength of 420 MPa (60 ksi) S235JR-S355JR, S235JO-S355JO, S235J2-S355J2, S275N-S420N, S275M-S420M, S275NL-S420NL, S275ML-S420ML, P235GH-P355GH, P275NL1-P355NL1, P275NL2-P355NL2, P215NL, P265NL, P355N, P285NH-P420NH, P195TR1-P265TR1, P195TR2-P265TR2, P195GH-P265GH, L245NB-L415NB, L245MB-L415MB, GE200-GE240, GE300, shipbuilding steels: A, B, D, E, A 32-F 36, A 40-F 40 ASTM A 106 Gr. A, B, C; A 181 Gr. 60, 70; A 283 Gr. A, C; A 285 Gr. A, B, C; A 350 Gr. LF1, LF2; A 414 Gr. A, B, C, D, E, F, G; A 501 Gr. B; A 513 Gr. 1018; A 516 Gr. 55, 60, 65, 70; A 573 Gr 58, 65, 70; A 588 Gr. A, B; A 633 Gr. A, C, D, E; A 662 Gr. A, B, C; A 707 Gr. L1, L2, L3; A 711 Gr. 1013; A 841 Gr. A, B, C; API 5 L Gr. B, X42, X52, X56, X60

## Typical analysis of all-weld metal (Wt-%)

C	Si	Mn		
0,08	0,4	1,2		

## Mechanical properties of all-weld metal

Heat Treatment	Yield strength 0,2%	Tensile strength	Elongation ( $L_0=5d_0$ )	Impact values in J CVN		
				+20°C:	-20°C:	-50°C:
untreated	460	560	27	190	160	70

## Operating data



Polarity = +

## Dimensions (mm)

## Amperage A

2,0 x 250	50-70
2,5 x 250/350	80-110
3,2 x 350/450	100-140
4,0 x 350/450	130-180
5,0 x 450	180-230
6,0 x 450	240-290

## Approvals and certificates

TÜV-D (0426.), DB (10.014.02), ABS (3H5, 4Y), BV (3YHHH), DNV (3YH10), GL (4Y40H15), LR (3, 3YH5), RMR (3YHH), RINA (4YH5 / 4H5), LTSS, SEPPOZ, CRS (3YH5), CE, NAKS

# Phoenix 120 K

Stick electrode

## Classifications

unalloyed basic

EN ISO 2560-A:

AWS A5.1:

E 42 5 B 32 H5

E7018-1

## Characteristics and field of use

Basic covered electrode. Very good welding characteristics including out of position work; 120 % weld metal recovery; H<sub>2</sub>- content in the weld metal ≤5 ml/100 g; very pure cryogenic weld metal at temperatures as low as -50 °C (-58 °F); CTOD tested up to -10 °C (14 °F). Suitable for use in structural steel work, boiler making, tank construction, ship and bridge building and vehicle manufacture; particularly suitable for welding fine grained structural steels. Excellent weldability on offshore steels. Redry for 2 h at 250 - 350 °C (482 - 662 °F).

## Base materials

S235JRG2 - S355J2, E295, E335, C 35; boiler steels P235GH, P265GH, P295GH, P355GH; fine grained structural steels up to S420N; shipbuilding steels A, B, D, E; offshore steels; pipe steels P265, P295, L290NB - L415NB, L290MB - L415MB; X 42 - X 60; cast steel GS-38, GS-45, GS-52; ageing resistant steels ASt 35 - ASt 52; ASTM A27 and A36 Gr. all, A214, A242 Gr. 1-5, A266 Gr. 1, 2, 4, A283 Gr. A, B, C, D, A285 Gr. A, B, C, A299 Gr. A, B, A328, A366, A515 Gr. 60, 65, 70, A516 Gr. 55, A570 Gr. 30, 33, 36, 40, 45, A572 Gr. 42, 50, A606 Gr. all, A607 Gr. 45, A656 Gr. 50, 60, A668 Gr. A, B, A907 Gr. 30, 33, 36, 40, A841, A851 Gr. 1, 2, A935 Gr. 45, A936 Gr. 50;

## Typical analysis of all-weld metal (Wt-%)

C	Si	Mn		
0,07	0,35	1,2		

## Mechanical properties of all-weld metal

Heat Treatment	Yield strength	Tensile strength	Elongation	Impact values	
	0,2%		(L <sub>0</sub> =5d <sub>0</sub> )	in J CVN	
	MPa	MPa	%	at RT	-50 °C:
untreated	420	510	22	120	47

## Operating data



Polarity = + / -

## Dimensions (mm)

## Amperage A

2,0 x 250	45-65
2,5 x 250	65-110
2,5 x 350	65-110
3,2 x 350	100-145
3,2 x 450	100-145
4,0 x 350	135-200
4,0 x 450	135-200
5,0 x 450	180-280
6,0 x 450	240-375
8,0 x 450	290-420

## Approvals and certificates

TÜV (Certificate No. 00348), DB (Reg. form No. 10.132.17), ABS, BV, GL, LR, DNV



## Classifications

unalloyed cellulotic

EN ISO 2560-A:

AWS A5.1:

E 38 3 C 2 1

E6010

## Characteristics and field of use

Cellulose coated stick electrode for vertical welding of the root (down and up), hot pass, filler and cover pass welding of large pipelines. Ideally suited for welding the root pass. Highly economical when compared with vertical up welding, also in combination with basic vertical down electrodes. BÖHLER FOX CEL is characterised by a very intensive, fine-droplet depositing, as well as good toughness properties. Insensitive to weather conditions, high resistance to the formation of shrinkage grooves. HIC and SSC resistance tested according to NACE TM 02-84 or TM 01-77.

## Base materials

S235JR, S275JR, S235J2G3, S275J2G3, S355J2G3, P235GH, P265GH, P355T1, P235T2-P355T2, L210NB-L385NB, L290MB-L385MB, P235G1TH, P255G1TH root pass up to L555NB, L555MB API Spec. 5 L: A, B, X 42, X 46, X 52, X 56, root pass up to X 80

## Typical analysis of all-weld metal (Wt-%)

C	Si	Mn		
0,12	0,14	0,5		

## Mechanical properties of all-weld metal

Heat Treatment	Yield strength 0,2%	Tensile strength	Elongation ( $L_0=5d_0$ )	Impact values in J CVN			
				+20°C:	±0°C:	-20°C:	-30°C:
untreated	450	550	26	100	90	80	50

## Operating data



Polarity = +/- -  
Minus Polarity for root pass only

## Dimensions (mm)

## Amperage A

2,5 x 250/300

50-90

3,2 x 350

80-130

4,0 x 350

120-180

5,0 x 350

160-210

## Approvals and certificates

TÜV-D (1281.), DNV (3), Statoil, SEPROZ, CE, NAKS (Ø 3.2; 4.0 mm)

## Classifications

unalloyed cellulosic

EN ISO 2560-A:

AWS A5.1:

E 38 2 C 2 1

E6010

## Characteristics and field of use

Cellulose coated stick electrode for vertical down welding in pipeline construction and in general pipe construction. Particularly suitable for root pass welding (down and up) using DC on the positive pole. BÖHLER FOX CEL+ permits good gap bridging, has good root fusion penetration due to the intensive, fine-droplet material transfer, high welding speeds and high resistance to the formation of root wormholes (piping).

## Base materials

S235JR, S275JR, S235J2G3, S275J2G3, S355J2G3, P235GH, P265GH, P355T1, P235T2-P355T2, L210NB-L385NB, L290MB-L385MB, P235G1TH, P255G1TH root pass up to L555NB, L555MB API Spec. 5 L: A, B, X 42, X 46, X 52, X 56, root pass up to X 80

## Typical analysis of all-weld metal (Wt-%)

C	Si	Mn		
0,17	0,15	0,6		

## Mechanical properties of all-weld metal

Heat Treatment	Yield strength 0,2%	Tensile strength	Elongation ( $L_0=5d_0$ )	Impact values in J CVN			
				+20°C:	±0°C:	-20°C:	-30°C:
untreated	450	520	26	105	95	65	

## Operating data



Polarity = +/- -  
Minus Polarity for root pass only

## Dimensions (mm)

## Amperage A

2,5 x 300	50-90
3,2 x 350	80-130
4,0 x 350	120-180

## Classifications

unalloyed cellulose

EN ISO 2560-A:

AWS A5.1:

E 42 2 C 25

E6010

## Characteristics and field of use

Cellulose covered electrode for vertical down circumferential welds in pipeline constructions. Excellent weldability in root pass welding (DC  $\pm$ ); also in the vertical up position. CTOD, HIC and HSCC tested. Do not redry!

## Base materials

API5L: Grade A, B, X 42, X 46, X 52, root pass welding up to X 80; EN 10208-2: L290MB-, 360MB- and root pass welding up to L485MB- and NB-qualities; EN 10113-3: S275ML, S355ML, S275NL, S355NL

## Typical analysis of all-weld metal (Wt-%)

C	Si	Mn		
0,14	0,18	0,55		

## Mechanical properties of all-weld metal

Heat Treatment	Yield strength 0,2%	Tensile strength	Elongation ( $L_0=5d_0$ )	Impact values in J CVN		
				at RT	-20°C:	-40°C
untreated	420	510	22	80	50	28

## Operating data



Polarity = +/- -  
Minus Polarity for root pass only

## Dimensions (mm)

## Amperage A

2,5 x 300	50-80
3,2 x 350	80-130
4,0 x 350	120-180
5,0 x 350	160-220

## Approvals and certificates

TÜV (Certificate No. 00247), DB (Reg. form No. 10.132.44), ABS, LR, GL, DNV, VNIIST

# Phoenix Cel 75

Stick electrode

## Classifications

unalloyed cellulosic

EN ISO 2560-A:

AWS A5.5:

E 42 2 C 25

E7010-P1

## Characteristics and field of use

Cellulose covered electrode for vertical down circumferential welds in pipeline constructions. Excellent weldability in root, hot, fill and cap pass welding. Easy slag removal. Particularly suitable for root pass welding (DC ±); also in the vertical up position. CTOD, HIC and HSCC tested. Do not redry!

## Base materials

API5L: Grade B, X 42 - X 60 and root pass up to X 70; EN 10208-2: L290MB-, L360MB- and root pass L485MB- and NB-qualities; EN 10113-3: S275ML, S355ML, S275NL, S355NL

## Typical analysis of all-weld metal (Wt-%)

C	Si	Mn		
0,15	0,20	0,60		

## Mechanical properties of all-weld metal

Heat Treatment	Yield strength 0,2%	Tensile strength	Elongation ( $L_0=5d_0$ )	Impact values in J CVN		
				MPa	MPa	%
untreated	420	530	22	80	55	28

## Operating data



Polarity = +/- -  
Minus Polarity for root pass only

## Dimensions (mm)

## Amperage A

3,2 x 350	80-130
4,0 x 350	120-180
5,0 x 350	160-220

## Approvals and certificates

TÜV (Certificate Approvals No. 03199), LR

**Classifications**

unalloyed cellulose

EN ISO 2560-A:

AWS A5.5:

E 42 3 C 2 5

E7010-P1

**Characteristics and field of use**

Higher-strength, cellulose coated stick electrode for vertical down welding on large pipelines. Highly economical compared to vertical up welding. Particularly suitable for hot pass, filler and cover pass welding on higher-strength pipe steels. BÖHLER FOX CEL 75 is characterised by a very intensive, fine-droplet depositing, as well as good toughness properties. Insensitive to weather conditions. HIC and SSC resistance tested according to NACE TM 02-84 or TM 01-77.

**Base materials**

S235JR, S275JR, S235J2G3, S275J2G3, S355J2G3, P235GH, P265GH, L210-L415NB, L290MB-L415MB, P355T1, P235T2-P355T2, P235G1TH, P255G1TH  
 root pass up to L480MB  
 API Spec. 5 L: Grade A, B, X42, X 46, X 52, X 56, X 60, root pass up to X 70

**Typical analysis of all-weld metal (Wt-%)**

C	Si	Mn		
0,14	0,14	0,7		

18

**Mechanical properties of all-weld metal**

Heat Treatment	Yield strength 0,2%	Tensile strength	Elongation ( $L_0=5d_0$ )	Impact values in J CVN				
				+20°C	±0°C	-20°C	-30°C	-40°C
untreated	480	550	23	100	95	65	55	45

**Operating data**

Polarity = + / - -  
 Minus Polarity for root pass only

**Dimensions (mm)**
**Amperage A**

3,2 x 350

80-130

4,0 x 350

120-180

5,0 x 350

160-210

**Approvals and certificates**

TÜV-A (533)

## Classifications

unalloyed cellulosic

EN ISO 2560-A:

AWS A5.5:

E 42 3 Mo C 2 5

E7010-A1

## Characteristics and field of use

Higher-strength, cellulose coated stick electrode for vertical down welding on large pipelines. Highly economical compared to vertical up welding. Particularly suitable for hot pass, filler and cover pass welding on higher-strength pipe steels. BÖHLER FOX CEL Mo is characterised by a very intensive, fine-droplet depositing, as well as good toughness properties. Insensitive to weather conditions, high resistance to the formation of shrinkage grooves. HIC and SSC resistance tested according to NACE TM 02-84 or TM 01-77.

## Base materials

S235JR, S275JR, S235J2G3, S275J2G3, S355J2G3, P235GH, P265GH, L210-L415NB, L290MB – L415MB, P355T1, P235T2-P355T2, P235G1TH, P255G1TH root pass up to L555MB API Spec. 5 L: Grade A, B, X 42, X 46, X 52, X 56, X 60, root pass up to X 80

## Typical analysis of all-weld metal (Wt-%)

C	Si	Mn	Mo
0,1	0,14	0,4	0,5

## Mechanical properties of all-weld metal

Heat Treatment	Yield strength 0,2%	Tensile strength	Elongation ( $L_0=5d_0$ )	Impact values in J CVN				
				20°C	±0°C	-20°C	-30°C	-40°C
untreated	480	550	23	100	95	85	50	42

## Operating data



Polarity = + / -  
Minus Polarity for root pass only

## Dimensions (mm)

## Amperage A

3,2 x 350

80-130

4,0 x 350

120-180

5,0 x 350

140-210

## Approvals and certificates

TÜV-D (11181.), CE

## Classifications

unalloyed cellulose

EN ISO 2560-A:

AWS A5.5:

E 46 3 C 25

E8010-P1

## Characteristics and field of use

Cellulose covered electrode for vertical down circumferential welds; for field welding of higher strength pipeline steels; excellent weldability in root, hot, fill and cap pass welding. Easy slag removal. Particularly suitable for root pass welding (DC  $\pm$ ), also in the vertical up position. Good bend and radio-graphic test results. High ductility of the welded joint and great safety against root pass cracking. Do not redry!

## Base materials

API5L: X 42, X 46, X 52, X 56, X 60, X 65, X 70 and root pass up to X 80 EN 10208-2: L290MB-, L485MB- and root pass up to L555MB- and NB-qualities; EN 10113-3: S355ML, S420ML, S460ML

## Typical analysis of all-weld metal (Wt-%)

C	Si	Mn	Ni	
0,16	0,20	0,85	0,20	

## Mechanical properties of all-weld metal

Heat Treatment	Yield strength 0,2%	Tensile strength	Elongation ( $L_0=5d_0$ )	Impact values in J CVN		
				at RT	-20°C:	-30°C
untreated	460	550	19	70	60	47

## Operating data



Polarity = +/- -  
Minus Polarity for root pass only

## Dimensions (mm)

## Amperage A

3,2 x 350	80-130
4,0 x 350	140-190
5,0 x 350	160-220

## Approvals and certificates

TÜV (Certificate No. 00536), ABS, LR

**Classifications** unalloyed cellulosic

EN ISO 2560-A:	AWS A5.5:	
E 46 4 1Ni C 2 5	E8010-P1	

**Characteristics and field of use**

Higher-strength, cellulose coated stick electrode for vertical down welding on large pipelines. Highly economical compared to vertical up welding. Particularly suitable for hot pass, filler and cover pass welding on higher-strength pipe steels. FOX CEL 85 is one of the most widely used cellulose electrodes, and meets the highest quality demands in large pipeline construction. It is characterised by a very intensive, fine-droplet depositing, as well as good toughness properties. Insensitive to weather conditions, high resistance to the formation of shrinkage grooves. HIC and SSC resistance tested according to NACE TM 02-84 or TM 01-77.

**Base materials**

L415NB-L450NB, L415MB-L450MB API Spec. 5 L: X 56, X 60, X 65

**Typical analysis of all-weld metal (Wt-%)**

C	Si	Mn	Ni	
0,14	0,15	0,75	0,7	

**Mechanical properties of all-weld metal**

Heat Treatment	Yield strength 0,2%	Tensile strength	Elongation ( $L_0=5d_0$ )	Impact values in J CVN			
				+20°C:	±0°C:	-20°C:	-40°C:
untreated	490	570	23	110	105	100	70

**Operating data**

	Polarity = +
---	--------------

Dimensions (mm)	Amperage A
3,2 x 350	80-130
4,0 x 350	120-180
5,0 x 350	160-210

**Approvals and certificates**

TÜV-D (1361.), ABS (E8010-P1), SEPROZ, CE



## Classifications

unalloyed cellulose

EN ISO 2560-A:

AWS A5.5:

E 50 3 1Ni C 2 5

E9010-P1

## Characteristics and field of use

Higher-strength, cellulose coated stick electrode for vertical down welding on large pipelines. Highly economical compared to vertical up welding. Particularly suitable for hot pass, filler and cover pass welding on higher-strength pipe steels. BÖHLER FOX CEL 90 meets the toughest quality demands in large pipeline construction, and is characterised by a very intensive, fine-droplet depositing, as well as toughness properties. Insensitive to weather conditions.

## Base materials

API5L: X 42, X 46, X 52, X 56, X 60, X 65, X 70 and root pass up to X 80 EN 10208-2: L290MB-, L485MB- and root pass up to L555MB- and NB-qualities; EN 10113-3: S355ML, S420ML, S460ML

## Typical analysis of all-weld metal (Wt-%)

C	Si	Mn	Ni	
0,17	0,15	0,9	0,8	

## Mechanical properties of all-weld metal

Heat Treatment	Yield strength 0,2%	Tensile strength	Elongation ( $L_0=5d_0$ )	Impact values in J CVN				
				20°C	±0°C	-20°C	-30°C	-40°C
untreated	580	650	21	100	90	75	65	40

## Operating data



Polarity = +  
Minus Polarity for root pass only

## Dimensions (mm)

## Amperage A

4,0 x 350

120-180

5,0 x 350

160-210

## Approvals and certificates

TÜV-D (1324.), Statoil, SEPROZ, CE

# Phoenix Cel 90

Stick electrode

## Classifications

unalloyed cellulosic

EN ISO 2560-A:

AWS A5.5:

E 50 3 1 Ni C 25

E9010-G

## Characteristics and field of use

Cellulose covered electrode for circumferential welds; developed for field welding of higher strength pipeline steels in the vertical down position. Excellent weldability in root, hot, fill and cap pass welding. Easy slag removal. Good bend and radiographic test results. High ductility of the welded joint. Do not redry!

## Base materials

API5L: X 60, X 65, X 70, (X 80) EN 10208-2: L415MB-, L450MB-, L485MB-, (L555MB-) and B-qualities; Phoenix Cel 90 is overmatching the X 60 and X 65 steels

## Typical analysis of all-weld metal (Wt-%)

C	Si	Mn	Ni	
0,18	0,20	0,85	0,75	

## Mechanical properties of all-weld metal

Heat Treatment	Yield strength 0,2%	Tensile strength	Elongation ( $L_0=5d_0$ )	Impact values in J CVN		
				MPa	MPa	%
untreated	530	630	18	70	55	47

## Operating data



Polarity = +/- -

## Dimensions (mm)

## Amperage A

3,2 x 350	80-140
4,0 x 350	140-190
5,0 x 350	160-220

## Approvals and certificates

TÜV (Approvals Certificate No. 00105)

## Classifications

low-alloy basic vertical up

EN ISO 2560-A:

AWS A5.1:

E 42 4 B 1 2 H5

E7016-1H4R

## Characteristics and field of use

BÖHLER FOX EV PIPE is a basic coated stick electrode particularly noted for its excellent welding performance in the vertical up welding of pipe root passes on the negative pole, as well as filler and cover pass welding on the positive pole. At wall thicknesses of 8 mm and above, the 3.2 mm electrode diameter can be used for the root weld. The shorter melting times that can be achieved, and the greater run-out lengths of each electrode, bring significant cost savings in comparison with the type AWS E7018 stick electrodes usually used for this purpose. The electrode is also well suited to use with AC, and can therefore also be used for AC welding in building and plant construction. The electrode features outstanding low-temperature impact energy and a low hydrogen content of max. 5 ml/100g in the weld metal.

## Base materials

EN P235GH, P265GH, P295GH, P235T1, P275T1, P235G2TH, P255G1TH, S255N-S420N1), S255NL1 up to S420NL1, L290NB up to L360NB, L290MB up to L415MB, L450MB2) up to L555MB2) API Spec. 5L: A, B, X 42, X46, X52, X56, X60, X65-X802) ASTM A53 Grade A-B, A106 Grade A-C, A179, A192, A210 Grade A-1 1) stress relieved up to S380N / S380NL1 2) only for root pass

## Typical analysis of all-weld metal (Wt-%)

C	Si	Mn		
0,06	0,6	0,9		

## Mechanical properties of all-weld metal

Heat Treatment	Yield strength 0,2%	Tensile strength	Elongation ( $L_0=5d_0$ )	Impact values in J CVN			
	MPa	MPa	%	+20°C:	-20°C:	-40°C:	-45°C:
untreated	470	560	29	170	100	60	55

## Operating data



Polarity = + / - / ~

## Dimensions (mm)

## Amperage A

2,0 x 300

30-60

2,5 x 300

40-90

3,2 x 350

60-130

4,0 x 350

110-180

## Approvals and certificates

TÜV-D (7620.), DB (10.014.77), LTSS, SEPROZ, CE, NAKS (Ø 2.5 - 4.0 mm), GAZPROM (Ø 2.5 - 4.0 mm)

**Classifications** low-alloy basic vertical down

EN ISO 2560-A:	AWS A5.5:	
E 46 5 1Ni B 4 5	E8045-P2	

**Characteristics and field of use**

Basic coated vertical down electrode for high quality welded joints on large pipelines and in building structures. Suitable for welding filler and cover passes in pipeline construction. Weld metal, particularly crack-resistant, with high toughness down to -50°C. Very low hydrogen content in the weld metal. The deposition rate is 80-100% higher than vertical up welding. Through its good welding properties this stick electrode permits easy processing even under difficult welding conditions. The special preparation of the striking ends gives maximum protection from start porosity. HIC and SSC resistance tested according to NACE TM 02-84 or TM 01-77.

**Base materials**

S235J2G3-S355J2G3, L290NB-L450NB, L290MB-L450MB, P235GH-P295GH API Spec. 5 L: A, B, X 42, X46, X 52, X 56, X 60, X 65

**Typical analysis of all-weld metal (Wt-%)**

C	Si	Mn	Ni	
0,05	0,4	1,1	0,9	

**Mechanical properties of all-weld metal**

Heat Treatment	Yield strength 0,2%	Tensile strength	Elongation (L <sub>0</sub> =5d <sub>0</sub> )	Impact values in J CVN				
				20°C	±0°C	-20°C	-40°C	-50°C
untreated	510	560	27	170	150	120	85	65

**Operating data**



Polarity = +

Dimensions (mm)	Amperage A
3,2 x 350	110-160
4,0 x 350	180-210
4,5 x 350	200-240

**Approvals and certificates**

TÜV-D (03531.), SEPROZ, CE

**Classifications** low-alloy basic vertical down

EN ISO 18275-A:	AWS A5.5:	
E 55 5 Z2Ni B 4 5	E9045-P2 (mod.)	

**Characteristics and field of use**

Basic coated vertical down electrode for high quality welded joints on large pipelines and in building structures. Suitable for welding filler and cover passes in pipeline construction. Weld metal, particularly crack-resistant, with high toughness. Through its good welding properties this stick electrode permits easy processing even under difficult welding conditions. The special preparation of the striking ends gives maximum protection from start porosity. Very low hydrogen content in the weld metal. The deposition rate is 80-100% higher than vertical up welding.

**Base materials**

L485MB, L555MB API Spec. 5 L: X70, X80

**Typical analysis of all-weld metal (Wt-%)**

C	Si	Mn	Ni	
0,05	0,3	1,2	2,2	

**Mechanical properties of all-weld metal**

Heat Treatment	Yield strength 0,2%	Tensile strength	Elongation ( $L_0=5d_0$ )	Impact values in J CVN				
				20°C	±0°C	-20°C	-40°C	-50°C
untreated	600	650	27	170	145	130	110	80

**Operating data**



Polarity = +

Dimensions (mm)	Amperage A
3,2 x 350	110-160
4,0 x 350	180-210
4,5 x 350	200-240

**Approvals and certificates**

TÜV-D (03402.), Statoil, SEPROZ, CE, GAZPROM (Ø 3.2; 4.0; 4.5 mm)

**Classifications** low-alloy basic vertical down

EN ISO 18275-A:	AWS A5.5:	
E 62 5 Z2Ni B 4 5	E10045-P2 (mod.)	

**Characteristics and field of use**

Basic coated vertical down electrode for high quality welded joints on large pipelines and in building structures. Suitable for welding filler and cover passes in pipeline construction. Weld metal, particularly crack-resistant, with high toughness. Through its good welding properties this stick electrode permits easy processing even under difficult welding conditions. The special preparation of the striking ends gives maximum protection from start porosity. Very low hydrogen content in the weld metal. The deposition rate is 80-100% higher than vertical up welding.

**Base materials**

L555MB API Spec. 5 L: X80

**Typical analysis of all-weld metal (Wt-%)**

C	Si	Mn	Ni	
0,07	0,4	1,2	2,3	

**Mechanical properties of all-weld metal**

Heat Treatment	Yield strength 0,2%	Tensile strength	Elongation ( $L_0=5d_0$ )	Impact values in J CVN			
				+20°C:	±0°C:	-20°C:	-50°C:
untreated	670	730	24	150	125	120	70

**Operating data**

	Polarity = +
--	--------------

Dimensions (mm)	Amperage A
4,0 x 350	180-210
4,5 x 350	200-240

**Approvals and certificates**

TÜV-D (06333.), SEPROZ, CE

## Classifications

low-alloy high strength

EN ISO 2560-A:

AWS A5.5:

E 46 6 1Ni B 42 H5

E8018-C3H4R

## Characteristics and field of use

Ni-alloy, basic coated stick electrode with exceptional quality figures, in particular with high toughness and crack resistance for higher-strength fine-grained structural steels. Approved for armour plates. Suitable for the temperature range from -60°C to +350°C. Very good impact energy in aged condition. Deposition efficiency about 115%. Easily handled in all positions except for vertical down. Very low hydrogen content in the weld metal (under AWS conditions HD ≤ 4 ml/100g).

## Base materials

general structural steels, pipe and boiler steels, cryogenic fine-grained structural steels and special qualities. S275N-S460N, S275NL-S460NL, S275M-S460M, S275ML-S460ML, P355N, P355NH, P460N, P460NH, P275NL1-P460NL1, P275NL2-P460NL2, L360NB, L415NB, L360MB-L450MB, L360QB-L450QB ASTM A 203 Gr. D, E; A 350 Gr. LF1, LF2, LF3; A 420 Gr. WPL3, WPL6; A 516 Gr. 60, 65, 70; A 572 Gr. 42, 50, 55, 60, 65; A 633 Gr. A, D, E; A 662 Gr. A, B, C; A 707 Gr. L1, L2, L3; A 738 Gr. A; A 841 A, B, C; API 5 L X52, X60, X65, X52Q, X60Q, X65Q

## Typical analysis of all-weld metal (Wt-%)

C	Si	Mn	Ni	
0,07	0,4	1,15	0,9	

## Mechanical properties of all-weld metal

Heat Treatment	Yield strength 0,2%	Tensile strength	Elongation (L <sub>0</sub> =5d <sub>0</sub> )	Impact values in J CVN	
	MPa	MPa	%	+20°C:	-60°C:
untreated	510	610	27	180	110

## Operating data



Polarity = +

## Dimensions (mm)

## Amperage A

2,5 x 350	80-100
3,2 x 350	110-140
4,0 x 450	140-180
5,0 x 450	190-230

## Approvals and certificates

TÜV-D (1524.), DNV (3 YHH), RMR (3 YHH), Statoil, LTSS, SEPROZ, CRS (3YH5), CE, VG 95132

# Phoenix SH Schwarz 3 K

Stick electrode

## Classifications

low-alloy high strength

EN ISO 2560-A:

AWS A5.5:

E 50 4 Mo B 42

E7015-G (E7015-A1 mod.)

## Characteristics and field of use

Basic covered electrode for welding high strength and creep resistant joints. High temperature resistant up to 500 °C (932 °F) and creep resistant up to 550 °C (1022 °F); high strength and cracking resistance; very low H<sub>2</sub>-content ≤5 ml/100 g. For welding creep resistant joints in boilers, tanks and pipeline constructions, especially suited for boiler steel 16 Mo 3. Redry for 2 h at 300 - 350 °C (572 - 662 °F).

## Base materials

boiler steels P235GH, P265GH, P295GH, P355GH, 16 Mo 3, 15 NiCuMoNb 5, 17 MnMoV 64, 13 MnNiMo 54, 20 MnMoNi 45; FK-steels S355N - S460N, P355NH - P460NH, P355NL1 - P460NL1; pipe steels L360NB - L415NB, L360MB - L485MB

## Typical analysis of all-weld metal (Wt-%)

C	Si	Mn	Ni	
0,08	0,30	1,20	0,45	

## Mechanical properties of all-weld metal

Heat Treatment	Yield strength 0,2%	Tensile strength	Elongation (L <sub>0</sub> =5d <sub>0</sub> )	Impact values in J CVN	
	MPa	MPa	%	at RT	-40 °C:
untreated	490	570	20	120	47

## Operating data



Polarity = +

## Dimensions (mm)

## Amperage A

2,5 x 350	70-100
3,2 x 350	110-140
4,0 x 350	130-190
5,0 x 450	160-230
6,0 x 450	220-310

## Approvals and certificates

TÜV (Certificate No. 01829), DB (Reg. form No. 10.132.14 and 20.132.15), ABS, GL, DNV



# Phoenix SH Schwarz 3 K Ni

Stick electrode

## Classifications

low-alloy high strength

EN ISO 2560-A:

AWS A5.5:

E 50 4 1 NiMo B 42 H5

E9018-G

## Characteristics and field of use

Basic covered NiMo alloyed electrode with a weld metal of special metallurgical purity for nuclear reactor construction. Quality controlled according to KTA 1408.2; very low H<sub>2</sub>-content ≤5 ml/100 g; NDT-tested. Used preferably for the welding of steels in the construction of nuclear reactors, boiler and pressure vessels; for fine grained structural steels up to S500Q. Redry for 2 h at 300 - 350 °C (572 - 662 °F).

## Base materials

20 MnMoNi 55, 22 NiMoCr 37, ASTM A 508 Cl 2, ASTM A 533 Cl 1 Gr. B, 15 NiCuMoNb 5 S 1 (WB 36), GS-18 NiMoCr 37, 11 NiMoV 53 (Welmonil 43), 12 MnNiMo 55 (Welmonil 35), S420N - S500Q, P460NH; ASTM A302 Gr. A-D; A517 Gr. A, B, C, E, F, H, J, K, M, P; A225 Gr. C; A572 Gr. 65

## Typical analysis of all-weld metal (Wt-%)

C	Si	Mn	P	S	Mo	Ni	Cu
0,06	0,30	1,25	<=0,01	<=0,01	0,40	0,95	<=0,08

## Mechanical properties of all-weld metal

Heat Treatment	Yield strength 0,2%	Tensile strength	Elongation (L <sub>0</sub> =5d <sub>0</sub> )	Impact values in J CVN	
	MPa	MPa	%	at RT	-40 °C:
untreated	540	620	20	140	50

## Operating data



Polarity = +

## Dimensions (mm)

## Amperage A

2,5 x 350

70-100

3,2 x 350

100-150

4,0 x 350

140-200

5,0 x 450

170-250

## Approvals and certificates

TÜV (Certificate No. 00512+08100)

## Classifications

low-alloy high strength

EN ISO 18275-A:

AWS A5.5:

E 55 6 1NiMo B 4 2 H5

E8018-GH4R

## Characteristics and field of use

Basic coated stick electrode of high toughness and crack-resistance for high-strength fine-grained structural steels. Cryogenic down to  $-60^{\circ}\text{C}$ , and resistant to ageing. Approved for armour plates. Easily handled in all positions except for vertical down. Very low hydrogen content in the weld metal (under AWS conditions  $\text{HD} \leq 4 \text{ ml}/100\text{g}$ ).

## Base materials

general structural steels, pipe and boiler steels, cryogenic fine-grained structural steels and special qualities. S460N, S460M, S460NL, S460ML, S460Q-S550Q, S460QL-S550QL, 460QL1-S550QL1, P460N, P460NH, P460NL1, P460NL2, L415NB, L415MB-L555MB, L415QB-L555QB, alform 500 M, 550 M, aldur 500 Q, 500 QL, 500 QL1, aldur 550 Q, 550 QL, 550 QL1, GE300, 20MnMoNi4-5, 15NiCuMoNb5-6-4 ASTM A 572 Gr. 65; A 633 Gr. E; A 738 Gr. A; A 852; API 5 L X60, X65, X70, X80, X60Q, X65Q, X70Q, X80Q

## Typical analysis of all-weld metal (Wt-%)

C	Si	Mn	Ni	Mo
0,06	0,3	1,2	0,8	0,35

## Mechanical properties of all-weld metal

Heat Treatment	Yield strength 0,2%	Tensile strength	Elongation ( $L_0=5d_0$ )	Impact values in J CVN	
	MPa	MPa	%	+20 °C:	-60 °C:
untreated	600	650	25	180	80

## Operating data



Polarity = +

## Dimensions (mm)

## Amperage A

2,5 x 350	80-100
3,2 x 350	100-140
4,0 x 450	140-180
5,0 x 450	190-230

## Approvals and certificates

TÜV-D (1802.), SEPROZ, CE, NAKS (Ø 3.2-4.0 mm), VG 95132

## Classifications

low-alloy high strength

EN ISO 18275-A:

AWS A5.5:

E 69 5 Mn 2 NiCrMo B 42 H5

E11018-G

## Characteristics and field of use

Basic covered NiCrMo alloyed electrode. Low H<sub>2</sub>-content ≤5 ml/100 g (HD) in the weld metal; very low moisture pickup during long term storage. For high strength fine grained structural steels, for cast steel qualities; weld metal insensitive to cold cracking. Redry for 2 h at 300 - 350 °C (572 - 662 °F).

## Base materials

Quenched and tempered fine grained structural steels up to 720 MPa yield point. High strength fine grained structural steels S620QL - S690QL, S620QL1, S690QU, HY 100, Suprafort 700, N-AXTRA 56, 63, 70

## Typical analysis of all-weld metal (Wt-%)

C	Si	Mn	Cr	Mo	Ni
0,06	0,20	1,60	0,38	0,40	1,85

## Mechanical properties of all-weld metal

Heat Treatment	Yield strength 0,2%	Tensile strength	Elongation (L <sub>0</sub> =5d <sub>0</sub> )	Impact values in J CVN	
	MPa	MPa	%	at RT	-50 °C:
untreated	700	750	18	120	47

## Operating data



Polarity = +

## Dimensions (mm)

## Amperage A

2,5 x 350	70-100
3,2 x 350	90-140
4,0 x 450	140-190
5,0 x 450	180-250

## Approvals and certificates

TÜV (Certificate No. 00548), DB (Reg. form No. 10.132.35), GL, WIWEB (for HY100 + Suprafort700), BV

**Classifications** low-alloy high strength

EN ISO 18275-A:	AWS A5.5:	
E 69 6 Mn2NiCrMo B 4 2 H5	E11018-GH4R	

**Characteristics and field of use**

Basic coated stick electrode of high toughness and crack-resistance for high-strength fine-grained structural steels. Cryogenic down to -60°C, and resistant to ageing. Easily handled in all positions except for vertical down. Very low hydrogen content in the weld metal (under AWS conditions HD ≤ 4 ml/100g).

**Base materials**

quenched and tempered fine-grained structural steels up to 690 MPa yield strength S620Q, S620QL, S690Q, S690QL, S620QL1-S690QL1, alform plate 620 M, 700 M, aldur 620 Q, 620 QL, 620 QL1, aldur 700 Q, 700 QL, 700 QL1 ASTM A 514 Gr. F, H, Q; A 709 Gr. 100 Type B, E, F, H, Q; A 709 Gr. HPS 100W

**Typical analysis of all-weld metal (Wt-%)**

C	Si	Mn	Cr	Ni	Mo
0,05	0,4	1,7	0,4	2,1	0,5

**Mechanical properties of all-weld metal**

Heat Treatment	Yield strength 0,2%	Tensile strength	Elongation (L <sub>0</sub> =5d <sub>0</sub> )	Impact values in J CVN	
				+20 °C:	-40 °C:
untreated	780	840	20	110	60

**Operating data**



Polarity = +

Dimensions (mm)	Amperage A
2,5 x 350	70-100
3,2 x 350	100-140
4,0 x 450	140-180
5,0 x 450	190-230

**Approvals and certificates**

TÜV-D (4313.), DB (10.014.22), SEPROZ, CE

**Classifications**

low-alloy creep resistant

EN ISO 3580-A:

AWS A5.5:

E Mo B 4 2 H5

E7018-A1H4R

**Characteristics and field of use**

Basic coated stick electrode for high quality welded joints on creep resistant boiler and pipe steels, preferred for 16Mo3. Approved for long-term use in operating temperature ranges up to 550°C. Particularly high toughness and crack resistance. Very low hydrogen content (under AWS conditions  $HD \leq 4 \text{ ml/100g}$ ). Deposition efficiency about 115%.

**Base materials**

creep-resistant steels and cast steels of the same type, steels resistant to ageing and to caustic cracking 16Mo3, 20MnMoNi4-5, 15NiCuMoNb5, S235JR-S355JR, S235JO-S355JO, S450JO, S235J2-S355J2, S275N-S460N, S275M-S460M, P235GH-P355GH, P355N, P285NH-P460NH, P195TR1-P265TR1, P195TR2-P265TR2, P195GH-P265GH, L245NB-L415NB, L450QB, L245MB-L450MB, GE200-GE300 ASTM A 29 Gr. 1013, 1016; A 106 Gr. C; A, B; A 182 Gr. F1; A 234 Gr. WP1; A 283 Gr. B, C, D; A 335 Gr. P1; A 501 Gr. B; A 533 Gr. B, C; A 510 Gr. 1013; A 512 Gr. 1021, 1026; A 513 Gr. 1021, 1026; A 516 Gr. 70; A 633 Gr. C; A 678 Gr. B; A 709 Gr. 36, 50; A 711 Gr. 1013; API 5 L B, X42, X52, X60, X65

**Typical analysis of all-weld metal (Wt-%)**

C	Si	Mn	Mo
0,08	0,35	0,8	0,45

**Mechanical properties of all-weld metal**

Heat Treatment	Yield strength 0,2%	Tensile strength	Elongation ( $L_0=5d_0$ )	Impact values in J CVN	
	MPa	MPa	%	+20 °C:	-50 °C:
untreated	510	590	24	170	60

**Operating data**

Polarity = +

**Dimensions (mm)**
**Amperage A**

2,5 x 250/350

80-110

3,2 x 350

100-140

4,0 x 350/450

130-180

5,0 x 450

190-230

**Approvals and certificates**

TÜV-D (0019.), KTA 1408.1 (8053.), DB (10.014.14), ABS (E 7018-A1), DNV (NV 0,3Mo), GL (15 Mo 3), RS (-), Statoil, LTSS, SEPROZ, CRS (3YH10), CE, NAKS

**Similar alloy filler metals**

Stick electrode:	FOX DMO Ti	Gas welding rod:	DMO
TIG rod:	DMO-IG	Wire/flux combination:	EMS 2 Mo with BB 24 BB 306, BB 400, BB 418 TT BB 421 TT
Solid wire electrode:	DMO-IG		
Flux cored wire:	DMO Ti-FD		

# Phoenix SH Schwarz 3 MK

Stick electrode

## Classifications

low-alloy creep resistant

EN ISO 3580-A:

AWS A5.5:

E Mo B 4 2 H5

E7018-A1

## Characteristics and field of use

Basic covered electrode. Very good welding characteristics in out of position work; easy slag removal; cold toughness at temperatures as low as  $-40\text{ }^{\circ}\text{C}$  ( $-40\text{ }^{\circ}\text{F}$ ). High temperature resistant up to  $500\text{ }^{\circ}\text{C}$  ( $932\text{ }^{\circ}\text{F}$ ) and creep resistant up to  $550\text{ }^{\circ}\text{C}$  ( $1022\text{ }^{\circ}\text{F}$ ). Particularly suitable for circumferential welds in conduit pipes as well as boiler, pressure vessel, header and nuclear reactor fabrication. Redry for 2 h at  $250 - 350\text{ }^{\circ}\text{C}$  ( $482 - 662\text{ }^{\circ}\text{F}$ ).

## Base materials

Boiler steels P235GH, P265GH, P295GH, 16 Mo 3, 20 MnMo 45, 16 Mo 5, 15 NiCuMoNb 5, 17 Mn-MoV 64; fine grained structural steels S355N - S460N, P355NH - P460NH, P355NL1 - P460NL1; pipe steels L360NB - L415NB, L360MB - L485MB, X 52 - X 70; ASTM A 355 Gr. P1; A161-94 Gr. T1; A217 Gr. WC1; A182M Gr. F1; A204M Gr. A, B, C; A250M Gr. T1

## Typical analysis of all-weld metal (Wt-%)

C	Si	Mn	Mo
0,06	0,35	0,8	0,45

## Mechanical properties of all-weld metal

Heat Treatment	Yield strength 0,2%	Tensile strength	Elongation ( $L_0=5d_0$ )	Impact values in J CVN	
				at RT	$-40\text{ }^{\circ}\text{C}$ :
untreated	480	560	20	120	47

## Operating data



Polarity = +

## Dimensions (mm)

## Amperage A

2,5 x 250	70-110
3,2 x 350	100-140
4,0 x 350	140-190
4,0 x 450	140-190
5,0 x 450	180-250

## Approvals and certificates

TÜV (Certificate No. 00902) DB (Reg. form No. 10.132.31) ABS LR DNV

### Classifications

low-alloy creep resistant

EN ISO 3580-A:

AWS A5.5:

E CrMo1 B 4 2 H5

E8018-B2H4R

### Characteristics and field of use

Basic coated stick electrode, core wire alloyed, for high quality welded seams in boiler and pipe steels, similar steel qualities, similar alloy quenched and tempered steels, untreated case hardening and nitriding steels. Preferred for 13CrMo4-5. Approved for long-term use in operating temperature ranges up to +570°C. Suitable for step cooling applications (Bruscati 15 ppm). High toughness and crack resistance, weld metal can be quenched and tempered. Very low hydrogen content (under AWS conditions HD ≤ 4 ml/100g). Deposition efficiency about 115 %. Preheating, interpass temperature and subsequent heat treatment according to the requirements of the base material in use (for 13CrMo4-5 at 200-250°C, temper after welding at 660-700°C, at least ½ h / furnace up to 300°C / air).

### Base materials

same alloy creep resistant steels and cast steel, case-hardening and nitriding steels with comparable composition, heat treatable steels with comparable composition, steels resistant to caustic cracking 1.7335 13CrMo4-5, 1.7262 15CrMo5, 1.7728 16CrMoV4, 1.7218 25CrMo4, 1.7225 42CrMo4, 1.7258 24CrMo5, 1.7354 G22CrMo5-4, 1.7357 G17CrMo5-5 ASTM A 182 Gr. F12; A 193 Gr. B7; A 213 Gr. T12; A 217 Gr. WC6; A 234 Gr. WP11; A335 Gr. P11, P12; A 336 Gr. F11, F12; A 426 Gr. CP12

### Typical analysis of all-weld metal (Wt-%)

C	Si	Mn	Cr	Mo	P	As	Sb	Sn
0,08	0,25	0,8	1,1	0,5	<=0,010	<=0,005	<=0,005	<=0,005

### Mechanical properties of all-weld metal

Heat Treatment	Yield strength 0,2%	Tensile strength	Elongation (L <sub>0</sub> =5d <sub>0</sub> )	Impact values in J CVN
	MPa	MPa	%	+40 °C:
t*	480	580	23	160

\*tempered 680 °C/2h / furnace up to 300 °C / air

### Operating data



Polarity = +

### Dimensions (mm)

### Amperage A

2,5 x 250/350

80-110

4,0 x 350/450

130-180

3,2 x 350

100-140

5,0 x 450

180-220

### Approvals and certificates

TÜV-D (0728.), DB (10.014.32), ABS (E 8018-B2), DNV (NV 1Cr 0.5Mo), GL (13 CrMo 44), LTSS, SEPROZ, CE, NAKS (Ø3.2 mm; Ø4.0 mm)

### Similar alloy filler metals

Stick electrode:	FOX DCMS Ti	TIG rod:	DCMS-IG
Solid wire electrode:	DCMS-IG	Flux cored wire:	DCMS Ti-FD
Gas welding rod:	DCMS	Wire/flux combination:	EMS 2 CrMo with BB 24, BB 24 SC, BB 418 TT

# Phoenix Chromo 1

Stick electrode

## Classifications

low-alloy creep resistant

EN ISO 3580-A:

AWS A5.5:

E CrMo1 B 4 2 H5

E8018-B2

## Characteristics and field of use

Basic covered CrMo alloyed electrode. Cryogenic, crack-free, suitable for quenching and tempering; resistant to caustic cracking; creep resistant in short time range up to 500 °C (932 °F) and in long time range up to 570 °C (1058 °F). Electrode for heavy-duty steam boiler and superheater tube fabrication; for quenched and tempered steels. Redry for 2 h at 300 up to 350 °C (572 up to 662 °F).

## Base materials

13 CrMo 4-5, GS-22 CrMo 54, 42 CrMo 4

## Typical analysis of all-weld metal (Wt-%)

C	Si	Mn	Cr	Mo	P	As	Sb	Sn
0,06	0,25	0,85	1,20	0,50	<=0,012	<=0,010	<=0,005	<=0,005

## Mechanical properties of all-weld metal

Heat Treatment	Yield strength	Tensile strength	Elongation	Impact values		
	0,2%		( $L_0=5d_0$ )	in J CVN		
	MPa	MPa	%	at RT	-20 °C:	-40 °C:
SR	460	550	22	120	100	60

## Operating data



Polarity = +

## Dimensions (mm)

## Amperage A

2,5 x 350	80-110
3,2 x 350	110-145
4,0 x 350	130-190
5,0 x 450	160-230

## Approvals and certificates

TÜV (Certificate No. 6535), Controlas (1073)



# Phoenix SH Chromo 2 KS

Slick electrode

**Classifications** low-alloy creep resistant

EN ISO 3580-A:	AWS A5.5:	
E CrMo2 B 4 2 H5	E9015-B3	

## Characteristics and field of use

Basic covered CrMo alloyed electrode. Extra low content of trace elements; step-cooling tested; not sensitive to long term embrittlement. Manufacture of chemical apparatus, hydrocrackers; for welding work on heavy-duty boilers, superheaters, superheater lines; for welding of CrMo and CrMoV alloyed steels for the petrochemical industry. Redry for 2 h at 300 - 350 °C (572 - 662 °F).

## Base materials

10 CrMo 9-10, 12 CrMo 9-10, 10 CrSiMoV 7, 15 CrMoV 5-10; ASTM A335 Gr. P22, A217 Gr. WC9

## Typical analysis of all-weld metal (Wt-%)

C	Si	Mn	Mo	Cr	P	As	Sb	Sn	S
0,07	0,25	0,70	0,90	2,2	<=0,012	<=0,010	<=0,005	<=0,005	<=0,010

## Mechanical properties of all-weld metal

Heat Treatment	Yield strength 0,2%	Tensile strength	Elongation (L <sub>0</sub> =5d <sub>0</sub> )	Impact values in J CVN		
	MPa	MPa	%	at RT	-30 °C:	-40 °C:
SR	440	550	22	130	90	80

## Operating data



Polarity = +

Dimensions (mm)	Amperage A
2,5 x 350	70-100
3,2 x 350	100-145
3,2 x 450	100-145
4,0 x 350	140-190
4,0 x 450	140-190
5,0 x 450	160-240

## Approvals and certificates

TÜV (Certificate No. 01823)

# Phoenix SH Kupfer 3 KC

Stick electrode

## Classifications

low-alloy creep resistant

EN ISO 3580-A:

AWS A5.5:

E ZCrMoV1 B 4 2 H5

E9015-G

## Characteristics and field of use

Basic covered CrMoV alloyed electrode. Good welding characteristics; uniform weld pattern; easy slag removal. Useable on low alloy creep resistant cast steel of the same composition. Redry for 2 h at 300 - 350 °C (572 - 662 °F).

## Base materials

GS-17 CrMoV 511, GS-17 CrMo 55; creep resistant and similar cast steel; 1.7706 – G17CrMoV5-10

## Typical analysis of all-weld metal (Wt-%)

C	Si	Mn	Cr	Mo	V
0,13	0,40	1,0	1,4	1,05	0,25

## Mechanical properties of all-weld metal

Heat Treatment	Yield strength 0,2%	Tensile strength	Elongation ( $L_0=5d_0$ )	Impact values in J CVN
	MPa	MPa	%	at RT
SR	520	630	18	40

## Operating data



Polarity = +

## Dimensions (mm)

## Amperage A

3,2 x 450

90-140

4,0 x 450

140-190

5,0 x 450

180-240

## Approvals and certificates

TÜV (Approvals Certificate No. 03187)

**Classifications** low-alloy creep resistant

EN ISO 3580-A:	AWS A5.5:	
E CrMo91 B 4 2 H5	E9015-B9	

**Characteristics and field of use**

Basic coated stick electrode, core wire alloyed, for highly creep resistant, quenched and tempered 9-12% chrome steels, particularly for T91 and P91 steels. Approved for long-term use in an operating temperature range of up to +650°C. The stick electrode provides good welding in all positions other than vertical down, and features good ignition properties.

**Base materials**

same type as highly creep resistant steels 1.4903 X10CrMoVNb9-1, GX12CrMoVNbN9-1 ASTM A 335 Gr. P91, A 336 Gr. F91, A 369 Gr. FP91, A 387 Gr. 91, A 213 Gr. T91

**Typical analysis of all-weld metal (Wt-%)**

C	Si	Mn	Cr	Ni	Mo	Nb	V	N
0,1	0,2	0,6	8,5	0,5	1,0	0,06	0,2	0,04

**Mechanical properties of all-weld metal**

Heat Treatment	Yield strength 0,2%	Tensile strength	Elongation ( $L_0=5d_0$ )	Impact values in J CVN
	MPa	MPa	%	+20 °C:
t*	580	710	19	75

\*tempered, 760 °C/2h / furnace up to 300 °C / air

**Operating data**

	Polarity = +
--	--------------

Dimensions (mm)	Amperage A
2,5 x 250	60-80
3,2 x 350	90-120
4,0 x 350	110-150
5,0 x 450	150-210

**Approvals and certificates**

TÜV-D (6762.), SEPROZ, CE

**Similar alloy filler metals**

TIG rod:	C 9 MV-IG	Metal powder wire:	C 9 MV-MC
Solid wire electrode:	C 9 MV-IG	Wire/flux combination:	C 9 MV-UP/BB 910
Flux cored wire:	C 9 MV Ti-FD		

**Classifications** low-alloy creep resistant

EN ISO 3580-A:	AWS A5.5:	
E ZCrMoVWnb 9 0,5 2 B 4 2 H5	E9015-B9 (mod.)	

**Characteristics and field of use**

BÖHLER FOX P 92 is a basic coated stick electrode that was specially developed for welding the creep resistant steel 1.4901 (NF 616, P 92). It is characterised by a stable arc, good ignition and re-ignition properties, low spatter formation and easily removable slag. Approved for long-term use at operating temperatures of up to +650°C.

**Base materials**

same type as highly creep resistant steels 1.4901 X10CrWMoVnb9-2, NF 616 ASTM A 213 Gr. T92; A 335 Gr. P92

**Typical analysis of all-weld metal (Wt-%)**

C	Si	Mn	Cr	Mo	Ni	W	V	N	Nb
0,1	0,3	0,7	8,6	0,55	0,7	0,06	0,2	0,04	0,04

**Mechanical properties of all-weld metal**

Heat Treatment	Yield strength	Tensile strength	Elongation	Impact values
	0,2%		( $L_0=5d_0$ )	
	MPa	MPa	%	+20 °C:
t*	600	740	20	55

\*tempered, 760°C/2h, furnace up to 300°C, air

**Operating data**



Polarity = +

Dimensions (mm)	Amperage A
2,5 x 300	80-110
3,2 x 350	90-140
4,0 x 350	130-180

**Approvals and certificates**

TÜV-D (9291.), SEPROZ, CE

**Similar alloy filler metals**

TIG rod:	P 92-IG	Flux cored wire:	P 92 Ti-FD
Wire/flux combination:	P 92-UP/BB 910		

## Classifications

low-alloy creep resistant

EN ISO 21952-A:

AWS A5.28:

E ZCrMoWVNb 9 0,5 1,5

ER90S-G

## Characteristics and field of use

High temperature resistant. Suited for joining and surfacing applications with matching high temperature resistant parent metal P92 according to ASTM A 335.

## Base materials

ASTM A 355 Gr. P92, NF 616; 1.4901 – X10CrWMoVNb9-2

## Typical analysis of all-weld metal (Wt-%)

C	Si	Mn	Cr	Mo	Ni	V	W	Nb	N
0,11	0,2	0,6	8,8	0,5	0,7	0,2	1,6	0,05	0,05

## Mechanical properties of all-weld metal

Heat Treatment	Yield strength 0,2%	Tensile strength	Elongation ( $L_0=5d_0$ )	Impact values in J CVN
	MPa	MPa	%	at RT
t*	560	720	15	41

\*tempered 760°C/>=2h

## Operating data



Polarity = +

Dimensions (mm)

Amperage A

2,5 x 300

80-110

3,2 x 350

90-140

4,0 x 350

130-180

## Approvals and certificates

TÜV-D (9291.), SEPROZ, CE

# Thermanit Chromo 9 V

Stick electrode

**Classifications** low-alloy creep resistant

EN ISO 3580-A:	AWS A5.5:	
E CrMo91 B 4 2 H5	E9015-B9	

## Characteristics and field of use

Basic covered CrMoVNb alloyed electrode. Good welding characteristics in out of position work; high temperature resistant weld metal. For quenched and tempered 9 % chromium steels, in particular P 91 / T 91 according to ASTM. Redry for 2 h at 300 - 350 °C (572 - 662 °F).

## Base materials

For quenched and tempered 9 % chromium steels, in particular P91 / T91 according to ASTM. X10CrMoVNb91 (1.4903), A 213-T91, A 335-P91, A 387 Gr. 91 (plates), A 182 F91 (forgings).

## Typical analysis of all-weld metal (Wt-%)

C	Si	Mn	Cr	Mo	Ni	V	Nb	N
0,09	0,2	0,6	9,0	1,1	0,8	0,2	0,05	0,04

## Mechanical properties of all-weld metal

Heat Treatment	Yield strength 0,2%	Tensile strength	Elongation ( $L_0=5d_0$ )	Impact values in J CVN
	MPa	MPa	%	at RT
t*	550	680	17	47

\*t 760°C/2h

## Operating data



Polarity = +

Dimensions (mm)	Amperage A
2,5 x 250	70-100
3,2 x 350	100-145
4,0 x 350	140-190
5,0 x 450	160-240

## Approvals and certificates

TÜV (Certificate No. 6173), Controlas (1353)

## Classifications low-alloy creep resistant

EN ISO 3580-A	AWS A5.5:	
E CrMo 9 1 B 42 H5	E9015-B9	

### Characteristics and field of use

High temperature resistant, resistant to scaling up to 600 °C (1112 °F). Suited for joining and surfacing applications with quenched and tempered 9% Cr steels, particularly for matching high temperature resistant parent metal T91 / P91 according to ASTM.

### Base materials

1.4903 – X10CrMoVNb9-1; ASTM A 199 Gr. T91, A213/213M Gr. T91, A355 Gr. P91 (T91)

### Typical analysis of all-weld metal (Wt-%)

C	Si	Mn	Cr	Mo	Ni	V	Nb	N
0,09	0,3	0,5	9,0	0,9	0,7	0,2	0,05	0,04

### Mechanical properties of all-weld metal

Heat Treatment	Yield strength 0,2%	Tensile strength	Elongation ( $L_0=5d_0$ )	Impact values in J CVN
	MPa	MPa	%	at RT
t*	550	680	17	47

\*tempered 760°C/2h

### Operating data



Polarity = +

### Dimensions (mm)

0,8	1,0	1,2	1,6
-----	-----	-----	-----

### Approvals and certificates

TÜV (Certificate No. 6166) Controlas

**Classifications** low-alloy creep resistant

EN ISO 3580-A:	AWS A5.5:	
E CrMo2 B 4 2 H5	E9018-B3H4R	

**Characteristics and field of use**

Basic coated stick electrodes, core wire alloyed, for components subject to high temperature stress in boiler, apparatus and pipeline construction, as well as in the petrochemical industry e.g. in cracking plants. Preferred for 10CrMo9 10. Approved for long-term use at operating temperatures of up to 600°C. For step cooling applications, a product range, specially developed for the purpose, is available. Crack-resistant, tough weld metal, high creep strength. Good welding properties in all positions other than vertical down. Weld metal can be nitrated, quenched and tempered. Deposition efficiency approx. 115%, low hydrogen content (under AWS conditions HD < 4 ml/100g).

**Base materials**

same type as creep-resistant steels and cast steels, similar alloy quenched and tempered steels up to 980 MPa strength, similar alloy case-hardening and nitriding steels 1.7380 10CrMo9-10, 1.7276 10CrMo11, 1.7281 16CrMo9-3, 1.7383 11CrMo9-10, 1.7379 G17CrMo9-10, 1.7382 G19CrMo9-10 ASTM A 182 Gr. F22; A 213 Gr. T22; A 234 Gr. WP22; 335 Gr. P22; A 336 Gr. F22; A 426 Gr. CP22

**Typical analysis of all-weld metal (Wt-%)**

C	Si	Mn	Cr	Mo	P	As	Sb	Sn
0,08	0,3	0,6	2,2	1,0	<=0,010	<=0,005	<=0,005	<=0,006

**Mechanical properties of all-weld metal**

Heat Treatment	Yield strength 0,2%	Tensile strength	Elongation ( $L_0=5d_0$ )	Impact values in J CVN
	MPa	MPa	%	+20°C:
t*	510	600	20	120

\*tempered, 720 °C/2h / furnace up to 300 °C / air

**Operating data**

Polarity = +

Dimensions (mm)	Amperage A
2,5 x 250	80-110
3,2 x 350	100-140
4,0 x 350/450	130-180
5,0 x 450	180-230

**Approvals and certificates**

TÜV-D (0722.), DB (10.014.30), ABS (E 9018-B3), DNV (NV 2,25Cr 1Mo), GL (10 CrMo 9 10), SEPROZ, CE, NAKS (Ø3.2; Ø4.0 mm)

**Similar alloy filler metals**

Stick electrode:	FOX CM 2 Kb SC	Flux cored wire:	CM 2 Ti-FD
Wire/flux combination:	CM 2-UP/BB 24	Solid wire electrode:	CM 2-IG
	CM 2-UP/BB 418 TT	TIG rod:	CM 2-IG



## Classifications

low-alloy creep resistant

EN ISO 3580-A:

AWS A5.5:

E CrMo5 B 4 2 H5

E8018-B6H4R

## Characteristics and field of use

Basic coated stick electrode, core wire alloyed, for creep resistant and high pressure hydrogen resistant steels in boiler construction and the petrochemical industry. Preferred for X12CrMo5. Approved for long-term use in an operating temperature range of up to +650°C. High crack resistance due to low hydrogen content (under AWS conditions HD ≤ 4 ml/100g). Good welding in all positions except for vertical down. Weld metal can be quenched and tempered, deposition efficiency about 115%.

## Base materials

same type as creep-resistant steels and cast steels, similar alloy quenched and tempered steels up to 1180 MPa 1.7362 X12CrMo5 ASTM A 182 Gr. F5; A 193 Gr. B5; A 213 Gr. T5; A217 Gr. C5; A 234 Gr. WP5; A 314 Gr. 501; A335 Gr. P5 and P5c; A 369 Gr. FB 5; A 387 Gr. 5; A 426 Gr. CP5

## Typical analysis of all-weld metal (Wt-%)

C	Si	Mn	Cr	Mo
0,08	0,3	0,8	5,0	0,6

## Mechanical properties of all-weld metal

Heat Treatment	Yield strength 0,2%	Tensile strength	Elongation (L <sub>0</sub> =5d <sub>0</sub> )	Impact values
				in J CVN
	MPa	MPa	%	+20°C:
t*	520	620	21	90

\*tempered, 730 °C/2h / furnace up to 300 °C / air

## Operating data



Polarity = +

Dimensions (mm)

Amperage A

2,5 x 250

70-90

3,2 x 350

110-130

4,0 x 350

140-170

## Approvals and certificates

TÜV-D (0725.), LTSS, SEPROZ, CE

## Similar alloy filler metals

TIG rod:	CM 5-IG	Solid wire electrode:	CM 5-IG
Wire/flux combination:	CM 5-UP/BB 24		

**Classifications** low-alloy creep resistant

EN ISO 3580-A:	AWS A5.5:	
E CrMo9 B 4 2 H5	E8018-B8	

**Characteristics and field of use**

Basic coated stick electrode, core wire alloyed, for creep resistant and high pressure hydrogen resistant boiler and pipe steels, particularly in the petrochemical industry. Preferred for X11CrMo9-1 (P9). Approved for long-term use in an operating temperature range of up to +600°C. Weld metal can be quenched and tempered, deposition efficiency about 115%.

**Base materials**

same type as highly creep resistant steels 1.7386 X11CrMo9-1, 1.7388 X7CrMo9-1 ASTM A 182 Gr. F9; A 213 Gr. T9; A 217 Gr. C12; A 234 Gr. WP9; A 335 Gr. P9; A 336 Gr. F9; A 369 Gr. FB9; A 387 Gr. 9 and 9CR; A 426 Gr. CP9; A 989 Gr. K90941

**Typical analysis of all-weld metal (Wt-%)**

C	Si	Mn	Cr	Mo
0,08	0,25	0,65	9,0	1,0

**Mechanical properties of all-weld metal**

Heat Treatment	Yield strength	Tensile strength	Elongation	Impact values
	0,2%		( $L_0=5d_0$ )	
	MPa	MPa	%	+20°C:
t*	610	730	20	70

t\* tempered, 760 °C / 1 h / furnace up to 300 °C / air

**Operating data**



Polarity = +

Dimensions (mm)	Amperage A
2,5 x 250	70-90
3,2 x 350	100-130
4,0 x 350	130-160

**Approvals and certificates**

TÜV-D (2183.), SEPROZ, CE

**Similar alloy filler metals**

TIG rod:	CM 9-IG		
----------	---------	--	--

**Classifications** low-alloy creep resistant

EN ISO 3580-A:

E CrMoWV12 B 4 2 H5

**Characteristics and field of use**

Basic coated, core wire alloyed electrode for highly creep resistant, quenched and tempered 12% Cr steels in turbine and boiler construction and in the chemical industry. Preferred for X20CrMoV11-1. Approved for long-term use at operating temperatures of up to +650°C. High creep strength and very good toughness under long-term stress. Strict composition tolerances ensure high-quality weld metal. Low hydrogen content (under AWS conditions  $HD \leq 4$  ml/100 g). Good welding in all positions except for vertical down. Weld metal can be quenched and tempered. Deposition efficiency about 115%.

**Base materials**

same and similar types to highly creep-resistant steels 1.4922 X20CrMoV11-1 (T550 Extra), 1.4935 X20CrMoWV12-1, 1.4923 X22CrMoV12-1, 1.4926 X21CrMoV12-1, 1.4913 X19CrMoNbVN 11-1 (T560 Extra), 1.4931 GX23CrMoV12-1

**Typical analysis of all-weld metal (Wt-%)**

C	Si	Mn	Cr	Ni	Mo	V	W
0,18	0,3	0,7	11,0	0,55	0,9	0,25	0,5

**Mechanical properties of all-weld metal**

Heat Treatment	Yield strength 0,2%	Tensile strength	Elongation ( $L_0=5d_0$ )	Impact values in J CVN
	MPa	MPa	%	+20°C:
t*	580	780	18	45

\*tempered, 760 °C / 4 h / furnace up to 300 °C / air

**Operating data**

Polarity = +

Dimensions (mm)	Amperage A
2,5 x 250	60-80
3,2 x 350	90-120
4,0 x 350	110-140
5,0 x 450	150-180

**Approvals and certificates**

TÜV-D (01082.), KTA 1408.1 (8088.), DB (10.014.31), LTSS, SEPROZ, CE

**Similar alloy filler metals**

TIG rod:	20 MWV-IG	Wire/flux combination:	20 MWV-UP/BB 24
----------	-----------	------------------------	-----------------

## Classifications

low-alloy creep resistant

EN ISO 3581-A:

AWS A5.4:

E 19 9 R

E308H-17

## Characteristics and field of use

Avesta 308/308H AC/DC is a high carbon Cr-Ni electrode primarily intended for welding 1.4948/ASTM 304H type stainless steels exposed to temperatures above 400°C.

## Base materials

For welding steels such as

Outokumpu	EN	ASTM	BS	NF	SS
4948	1.4948	304H	305S51	Z6 CN 18-09	2333
4301	1.4301	304	304S31	Z7 CN 18-09	2333
4541	1.4541	321	321S31	Z6 CNT 18-10	2337
-	1.4550	347	347S31	Z6 CNNb 18-10	2338

## Typical analysis of all-weld metal (Wt-%)

C	Si	Mn	Cr	Ni
0,06	0,7	1,1	20,0	10,0

## Mechanical properties of all-weld metal

Heat Treatment	Yield strength	Tensile strength	Elongation	Impact values	
	0,2%		( $L_0=5d_0$ )	in J CVN	
	MPa	MPa	%	+20°C:	-40°C:
untreated	450	605	37	55	50

## Operating data



Polarity = + / -

## Dimensions (mm)

## Amperage A

2,5 x 300	50-80
3,25 x 350	80-120
4,0 x 350	130-160
5,0 x 350	160-220

**Classifications**

low-alloy creep resistant

EN ISO 3581-A:

AWS A5.4:

E 19 9 H R 4 2

E308H-16

**Characteristics and field of use**

Rutile-basic coated stick electrode for highly creep resistant austenitic CrNi steels, for operating temperatures up to +700°C. BÖHLER FOX E 308 H was specially formulated for the 304 H base material. Resistant to hot cracking and little tendency to embrittlement through controlled ferrite content (3-8 FN), scale-resistant. Very good welding in all positions except for vertical down.

**Base materials**

same type as highly creep resistant steels 1.4948 X6CrNi18-10, 1.4878 X8CrNiTi18-10, 1.4940 X7CrNiTi18-10, 1.4910 X3CrNiMoBN17-13-3 AISI 304H, 321H, 347H

**Typical analysis of all-weld metal (Wt-%)**

C	Si	Mn	Cr	Ni
0,05	0,6	0,8	19,8	10,2

**Mechanical properties of all-weld metal**

Heat Treatment	Yield strength 0,2%	Tensile strength	Elongation ( $L_0=5d_0$ )	Impact values in J CVN
	MPa	MPa	%	+20°C:
untreated	420	580	40	75

**Operating data**

Polarity = + / -

**Dimensions (mm)**
**Amperage A**

2,5 x 300	45-75
3,2 x 350	70-110
4,0 x 350	110-145

**Approvals and certificates**

TÜV-D (11178.), CE, SEPROZ

**Similar alloy filler metals**

Stick electrode:	FOX CN 18/11	Flux cored wire:	E 308 H-FD
Wire/flux combination:	CN 18/11-UP/BB 202	TIG rod:	ER 308 H-IG E 308 H PW-FD CN 18/11-IG
Solid wire electrode:	CN 18/11-IG		

# Thermanit ATS 4

Stick electrode

**Classifications** low-alloy creep resistant

EN 1600	AWS A5.4	
E 19 9 H B 2 2	E308H-15	

## Characteristics and field of use

High temperature resistant up to 700 °C (1292 °F); resistant to scaling up to 800 °C (1472 °F). For surfacing and joining applications on matching/similar high temperature resistant steels/cast steel grades.

## Base materials

TÜV certified parent metals 1.4948 – X6CrNi18-11 1.4878 – X12CrNiTi18-9 1.4550 – X6CrNiNb18-10 AISI 304, 304H, 321H, 347H

## Typical analysis of all-weld metal (Wt-%)

C	Si	Mn	Cr	Ni
0,05	0,3	1,6	18,5	9,5

## Mechanical properties of all-weld metal

Heat Treatment	Yield strength 0,2%	Tensile strength	Elongation ( $L_0=5d_0$ )	Impact values in J CVN
	MPa	MPa	%	at RT
untreated	350	550	35	70

## Operating data



Polarity = +

Dimensions (mm)	Amperage A
2,5 x 300	55- 80
3,2 x 350	80-105
4,0 x 350	90-135
5,0 x 450	150-190

## Approvals and certificates

TÜV (Certificate No. 01526)

# BÖHLER FOX 2,5 Ni

Stick electrode

## Classifications

low-alloy cryogenic

EN ISO 2560-A:

AWS A5.5:

E 46 8 2Ni B 42 H5

E8018-C1H4R

## Characteristics and field of use

Ni-alloy, basic coated stick electrode for unalloyed and Ni-alloy fine-grained structural steels. Tough, crack-resistant weld metal. The weld metal is cryogenic down to -80°C. Ideal weldability in all positions except for vertical down. Very low hydrogen content (under AWS conditions HD ≤ 4 ml/100g).

## Base materials

cryogenic structural and Ni-alloy steels, special cryogenic shipbuilding steels. 10Ni14, 12Ni14, 13MnNi6-3, 15NiMn6, S275N-S460N, S275NL-S460NL, S275M-S460M, S275ML-S460ML, P275NL1-P460NL1, P275NL2-P460NL2 ASTM A 203 Gr. D, E; A 333 Gr. 3; A334 Gr. 3; A 350 Gr. LF1, LF2, LF3; A 420 Gr. WPL3, WPL6; A 516 Gr. 60, 65; AA 529 Gr. 50; A 572 Gr. 42, 65; A 633 Gr. A, D, E; A 662 Gr. A, B, C; A 707 Gr. L1, L2, L3; A 738 Gr. A; A 841 A, B, C

## Typical analysis of all-weld metal (Wt-%)

C	Si	Mn	Ni
0,04	0,3	0,8	2,4

## Mechanical properties of all-weld metal

Heat Treatment	Yield strength 0,2%	Tensile strength	Elongation ( $L_0=5d_0$ )	Impact values in J CVN	
				+20°C:	-80°C:
untreated	490	570	30	180	110

## Operating data



Polarity = +

Dimensions (mm)	Amperage A
2,5 x 350	70-100
3,2 x 350	110-140
4,0 x 450	140-180
5,0 x 450	190-230

## Approvals and certificates

TÜV-D (00147.), DB (10.014.16), ABS (Ni 2.1/2.6), BV (5Y40), WIWEB, DNV (5 YH10), GL (8Y46), LR (5Y40mH15), RINA (5YH5, 3H5), Statoil, SEPROZ, CE

## Similar alloy filler metals

TIG rod:	2.5 Ni-IG	Solid wire electrode:	2.5 Ni-IG
Wire/flux combination:	Ni 2-UP/BB24 Ni 2-UP/BB 421 TT		





## Chapter 1.2 - Stick electrodes (high-alloyed)

Product name	EN ISO	AWS	Page
B F A	B		
A esta M			
B F A A			
er anit J			
A esta			
B F A			
B F A M	B		
A esta r o			
A esta			
A esta			
A esta			
A esta A			
B F A M A			
er anit			
B F A	B		
B F A A			
er anit A			
A esta M			
B F A	B		
B F A A			
B F	B	iMo	
B F A	Mn B	o	
er anit	Mn B	o	
B F A A	MnMo	o	
er anit	Mn	o	
B F M		Mo o	
A esta			
B F M A		o	
A esta MA			
Mn	B		
A esta asic	B		
A esta			
A esta A			
B F			
A esta			
A esta		Mo	
A esta Mo A		Mo	
B F FFB	B	o	
B F FFB A			
A esta			
A esta			
er anit	B	o	
er anit	B		
A esta A			
er anit		o	
B F A			
A esta			
	B		
B F iBA	i i r Mo	i rMo	
er anit	i i r Mo	i rMo	

## Chapter 1.2 - Stick electrodes (high-alloyed)

Mo	i i r Mo	i rMo	
B F iBA	i i r Mn	i rFe o	
er anit icro	i i r Mn	i rFe o	
	i i r Mn	i rFe o	
	i i r o Mo	i r oMo	
er anit icro	i i r Fe Mn	i rFe	
	i i r Mo	i rMo	
er anit iMo	i i r Mo	i rMo	
	i i r Fe Mn	i rFe	
Mo	i i r Fe Mo	i rFe	
Mo	i i r Mo Fe	i rMo	
M	i i Mn i	i	
A esta asic	i r Mo	i rMo	

## Classifications

high-alloyed

EN ISO 3581-A:

AWS A5.4:

E 19 9 LB 2 2

E308L-15

## Characteristics and field of use

Low carbon, core wire alloyed austenitic stick electrode with basic coating. For application in all branches of industry where same-type steels, including higher-carbon steels and ferritic 13% chrome steels are welded. Developed for first-class welded joints with very good root and position welding. Good gap bridging and easy control of the weld pool and of the slag. Easy slag removal even in tight seams. The clean surface of the seam guarantees short reworking times. Exceptionally suitable for thick-walled, stressed constructions and for assembly welding. Resists intergranular corrosion up to +350°C. This product is also available as a LF (low ferrite) type.

## Base materials

1.4306 X2CrNi19-11, 1.4301 X5CrNi18-10, 1.4311 X2CrNiN18-10, 1.4312 GX10CrNi18-8, 1.4541 X6CrNiTi18-10, 1.4546 X5CrNiNb18-10, 1.4550 X6CrNiNb18-10 AISI 304, 304L, 304LN, 302, 321, 347, ASTM A157 Gr. C9, A320 Gr. B8C or D

## Typical analysis of all-weld metal (Wt-%)

C	Si	Mn	Cr	Ni
0,03	0,4	1,3	19,8	9,6

FN 4-10

## Mechanical properties of all-weld metal

Heat Treatment	Yield strength 0,2%	Tensile strength	Elongation ( $L_0=5d_0$ )	Impact values in J CVN		
				+20°C:	-196°C:	
untreated	420	590	38	110	50	

## Operating data



Polarity = +

## Dimensions (mm)

2,5 x 300

3,2 x 350

4,0 x 350

## Amperage A

50-80

80-110

110-140

## Approvals and certificates

TÜV-D (0152.), DB (30.014.10), Statoil, SEPROZ, CE

## Similar alloy filler metals

GMAW solid wire:	FOX EAS 2-A FOX EAS 2-VD FOX EAS 2 (LF)	Flu cored wire:	EAS 2 MC EAS 2-FD EAS 2 PW-FD EAS 2 PW-FD (LF)
TIG rod:	EAS 2-IG	Solid wire electrode:	EAS 2-IG (Si)
Wire/flux combination:	EAS 2-UP/BB 202		

## Classifications

high-alloyed

EN ISO 3581

AWS A5.4:

E 19 9 L R

E308L-17

## Characteristics and field of use

Avesta 308L/MVR is a Cr-Ni electrode for all position welding of 1.4301/ASTM 304 type stainless steels. Corrosion resistance: Very good under fairly severe conditions, e.g. in oxidising acids and cold or dilute reducing acids.

## Base materials

Outokumpu	EN	ASTM	BS	NF	SS
4301	1.4301	304	304S31	Z7 CN 18-09	2333
4307	1.4307	304L	304S11	Z3 CN 18-10	2352
4311	1.4311	304LN	304S61	Z3 CN 18-10 Az	2371
4541	1.4541	321	321S31	Z6 CNT 18-10	2337

## Typical analysis of all-weld metal (Wt-%)

C	Si	Mn	Cr	Ni
0,02	0,8	0,6	19,5	10,0

Ferrite 8 FN; WRC-92

## Mechanical properties of all-weld metal

Heat Treatment	Yield strength 0,2%	Tensile strength 1,0%	Elongation ( $L_0=5d_0$ )	Impact values in J CVN		
				+20°C:	-40°C:	-196°C:
untreated	440	570	37	60	40	27

## Operating data



Polarity = + / -

## Dimensions (mm)

## Amperage A

2,0 x 300	30-55
2,5 x 350	45-70
3,25 x 350	60-110
4,0 x 450	90-150
5,0 x 450	140-200

## Classifications

high-alloyed

EN ISO 3581-A:

AWS A5.4:

E 19 9 LR 3 2

E308L-17

## Characteristics and field of use

Low carbon, core wire alloyed, austenitic stick electrode with rutile coating. For application in all branches of industry where same-type steels, including higher-carbon steels and ferritic 13% chrome steels are welded. Special fine welding properties, excellent welding with AC power and a high resistance to hot cracking in the weld metal are features of this product. The exceptional position welding capacity and the self-releasing slag are of significant economic importance. Resists intergranular corrosion up to +350 C.

## Base materials

1.4306 X2CrNi19-11, 1.4301 X5CrNi18-10, 1.4311 X2CrNiN18-10, 1.4312 G-X10CrNi18-8, 1.4541 X6CrNiTi18-10, 1.4546 X5CrNiNb18-10, 1.4550 X6CrNiNb18-10 AISI 304, 304L, 304LN, 302, 321, 347, ASTM A157 Gr. C9, A320 Gr. B8C or D

## Typical analysis of all-weld metal (Wt-%)

C	Si	Mn	Cr	Ni
0,03	0,8	0,8	19,8	10,2

## Mechanical properties of all-weld metal

Heat Treatment	Yield strength 0,2%	Tensile strength	Elongation ( $L_0=5d_0$ )	Impact values in J CVN		
	MPa	MPa	%	+20°C:	-120°C:	-196°C:
untreated	430	560	40	70	≥ 32	≥ 32

## Operating data



Polarity = + / -

## Dimensions (mm)

## Amperage A

1,5 x 250	25-40
2,0 x 300	40-60
2,5 x 250/350	50-90
3,2 x 350	80-110
4,0 x 350	110-160
5,0 x 450	140-200

## Approvals and certificates

TÜV-D (1095.), DB (30.014.15), ABS (E 308L-17), GL (4306), Statoil, VUZ, SEPPOZ, CE, CWB, NAKS (Ø3.2 mm; Ø4.0 mm)

## Similar alloy filler metals

GMAW solid wire:	FOX EAS 2 FOX EAS 2-VD	Flu cored wire:	EAS 2 MC EAS 2-FD
Solid wire electrode:	EAS 2-IG (Si)		EAS 2 PW-FD EAS 2 PW-FD (LF)
Wire/flux combination:	EAS 2-UP/BB 202	TIG rod:	EAS 2-IG

# Thermanit JEW 308L-17

Stick electrode

## Classifications

high-alloyed

EN ISO 3581-A:

AWS A5.4:

E 19 9 L R 3 2

E308L-17

## Characteristics and field of use

Stainless; resistant to intercrystalline corrosion and wet corrosion up to 350 °C (662 °F). Corrosion resistant similar to matching low carbon and stabilized austenitic 18/8 CrNi(N) steels/cast steel grades. Good resistance to nitric acid. For joining and surfacing applications with matching and similar – stabilized and non stabilized – CrNi(N) steels/cast steel grades. Cold toughness at subzero temperatures as low as -105 °C (-157 °F).

## Base materials

1.4311 – X2CrNi18-10, 1.4550 – X6CrNiNb18-10; AISI 304, 304L, 304LN, 302, 321, 347; ASTM A157 Gr. C9; A320 Gr. B8C or D

## Typical analysis of all-weld metal (Wt-%)

C	Si	Mn	Cr	Ni
0,04	0,9	0,8	19,5	9,5

## Mechanical properties of all-weld metal

Heat Treatment	Yield strength 0,2%	Tensile strength	Elongation ( $L_0=5d_0$ )	Impact values in J CVN	
	MPa	MPa	%	+20 °C:	-105°C:
untreated	320	550	35	65	40

## Operating data



Polarity = + / ~

## Dimensions (mm)

## Amperage A

2,0 x 300	40-60
2,5 x 350	50-90
3,2 x 350	80-120
4,0 x 350	110-160
5,0 x 450	140-200

## Approvals and certificates

TÜV (Certificate No. 00558), DB (Reg. form No. 30.132.07), CWB

# Avesta 309L

Stick electrode

## Classifications

high-alloyed

EN ISO 3581-A:

AWS A5.4:

E 23 12 L R

E309L-17

## Characteristics and field of use

Avesta 309L is a high-alloyed low carbon electrode designed for welding dissimilar joints between stainless and mild or low-alloy steels. The electrode is well suited as a buffer layer when overlay welding on mild steels, providing an 18 Cr 8 Ni deposit from the very first layer. Avesta 309L can also be used for welding some high temperature steels, such as 1.4833/ASTM 309S.

## Base materials

For welding steels such as					
Outokumpu	EN	ASTM	BS	NF	SS
High-alloyed low carbon electrode for surfacing unalloyed steel, joint welding molybdenum-alloyed stainless steel to unalloyed steel and for welding clad material.					

## Typical analysis of all-weld metal (Wt-%)

C	Si	Mn	Cr	Ni
0,02	0,8	0,8	23,0	13,3
FN 12; WRC-92				

## Mechanical properties of all-weld metal

Heat Treatment	Yield strength 0,2%	Tensile strength	Elongation ( $L_0=5d_0$ )	Impact values in J CVN	
				+20 °C:	-40°C:
untreated	450	570	35	50	45

## Operating data



Polarity = + / -

## Dimensions (mm)

## Amperage A

2,0	35--60
2,5	50-80
3,25	80-120
4,0	100-160
5,0	160-220

**Classifications**

high-alloyed

EN ISO 3581-A:

AWS A5.4:

E 23 12 L R 3 2

E309L-17

**Characteristics and field of use**

Core wire alloyed, low-carbon, austenitic stick electrode with rutile coating. High crack resistance with hard-to-weld materials, austenite-ferrite joints and weld claddings is achieved through the increased ferrite content (FN ~17) in the weld metal. Particularly good fine welding properties and excellent AC weldability characterise this product. For operating temperatures between -60°C and +300°C, for the first layer of weld claddings up to +400°C.

**Base materials**

Joints of and between high-strength, unalloyed and alloyed quenched and tempered steels, stainless, ferritic Cr and austenitic Cr-Ni steels, austenitic manganese steels and weld claddings: for the first layer of chemically resistant weld claddings on the ferritic-pearlitic steels used for boiler and pressure vessel construction up to fine-grained structural steel S500N, and for the creep resistant fine-grained structural steels 22NiMoCr4-7, 20MnMoNi5-5 and GS-18NiMoCr 3 7

**Typical analysis of all-weld metal (Wt-%)**

C	Si	Mn	Cr	Ni
0,02	0,7	0,8	23,2	12,5

**Mechanical properties of all-weld metal**

Heat Treatment	Yield strength 0,2%	Tensile strength	Elongation ( $L_0=5d_0$ )	Impact values in J CVN	
				+20°C:	-60°C:
untreated	460	570	40	55	≥ 32

**Operating data**

Polarity = + / ~

Dimensions (mm)	Amperage A
2,5 x 350	60-80
3,2 x 350	80-110
4,0 x 350/450	110-140
5,0 x 450	140-180

**Approvals and certificates**

TÜV-D (1771.), DB (30.014.08), ABS (E 309L-17), BV (UP), DNV (NV 309 L), GL (4332), LR (DXV and O, CMN55), SEPROZ, CE, CWB, NAKS (Ø3.2 mm; Ø4.0 mm)

**Similar alloy filler metals**

Stick electrode:	FOX CN 23/12 Mo-A	Metal powder wire:	CN 23/12-MC
TIG rod:	CN 23/12-IG	Wire/flux combination:	CN 23/12-UP/BB 202
Solid wire electrode:	CN 23/12-IG	Flu cored wire:	CN 23/12-FD CN 23/12 PW-FD CN 23/12 Mo-FD CN 23/12 Mo PW-FD



**BÖHLER FOX EAS 4 M**

Stick electrode

**Classifications**

high-alloyed

EN ISO 3581-A:

AWS A5.4:

E 19 12 3 L B 2 2

E316L-15

**Characteristics and field of use**

Low carbon, core wire alloyed austenitic stick electrode with basic coating. For application in all branches of industry where same-type steels, including higher-carbon steels and ferritic 13% chrome steels are welded. The weld metal has high toughness. It is therefore preferred for welding thick cross sections. Very good position welding. Cryogenic down to -196°C. Resists intergranular corrosion up to +400 C.

**Base materials**

1.4401 X5CrNiMo17-12-2, 1.4404 X2CrNiMo17-12-2, 1.4435 X2CrNiMo18-14-3, 1.4436 X3CrNiMo17-13-3, 1.4571 X6CrNiMoTi17-12-2, 1.4580 X6CrNiMoNb17-12-2, 1.4583 X10CrNiMoNb18-12, 1.4409 GX2CrNiMo19-11-2 UNS S31603, S31653; AISI 316L, 316Ti, 316Cb

**Typical analysis of all-weld metal (Wt-%)**

C	Si	Mn	Cr	Ni	Mo
0,03	0,4	1,2	18,8	11,8	2,7

**Mechanical properties of all-weld metal**

Heat Treatment	Yield strength 0,2%	Tensile strength	Elongation ( $L_0=5d_0$ )	Impact values in J CVN		
				+20°C:	-120°C:	-196°C:
untreated	460	600	38	90	≥ 32	≥ 27

**Operating data**

Polarity = +

**Dimensions (mm)****Amperage A**

2,5 x 300

50-80

3,2 x 350

80-110

4,0 x 350

110-140

**Approvals and certificates**

TÜV-D (0772.), DNV (316), Statoil, SEPROZ, CE

**Similar alloy filler metals**

Stick electrode:	FOX EAS 4 M-A FOX EAS 4 M-VD FOX EAS 4 M-TS FOX EAS 4 M (LF)	Flu cored wire:	EAS 4 M-MC EAS 4 M-FD EAS 4 PW-FD EAS 4 PW-FD (LF)
TIG rod:	EAS 4 M-IG	Wire/flux combination:	EAS 4 M-UP/BB 202
Solid wire electrode:	EAS 4 M-IG (Si)		

**Classifications**

high-alloyed

EN ISO 3581-A:

AWS A5.4:

E 19 12 3 L R

E316L-16

**Characteristics and field of use**

Avesta 316L/SKR Cryo is a Cr-Ni-Mo electrode for all position welding of austenitic stainless steels such as 1.4436/ASTM 316. The carefully controlled chemical composition gives a weld metal with a ferrite content in the range of 3 – 8 FN (WRC-92) and very good toughness down to -196°C.

**Base materials**

For welding steels such as					
Outokumpu	EN	ASTM	BS	NF	SS
4436	1.4436	316	316S33	Z7 CND 18-12-03	2343
4432	1.4432	316L	316S13	Z3 CND 17-12-03	2353
4429	1.4429	S31653	316S63	Z3 CND 17-12 Az	2375
4571	1.4571	316Ti	320S31	Z6 CNDT 17-12	2350

**Typical analysis of all-weld metal (Wt-%)**

C	Si	Mn	Cr	Ni	Mo
0,02	0,4	1,2	17,2	12,3	2,6

**Mechanical properties of all-weld metal**

Heat Treatment	Yield strength 0,2%	Tensile strength	Elongation ( $L_0=5d_0$ )	Impact values in J CVN
	MPa	MPa	%	-196°C:
untreated	450	570	35	42

**Operating data**

Polarity = +

Dimensions (mm)

Amperage A

2,5

50-80

3,25

70-120

4,0

100-160

## Classifications

high-alloyed

EN ISO 3581-A:

AWS A5.4:

E 19 12 3 L R

E316L-17

## Characteristics and field of use

Avesta 3D 316L/SKR is an all position Cr-Ni-Mo electrode for welding ASTM 316 and 316L stainless steels.

## Base materials

For welding steels such as					
Outokumpu	EN	ASTM	BS	NF	SS
4436	1.4436	316	316S33	Z7 CND 18-12-03	2343
4432	1.4432	316L	316S13	Z3 CND 17-12-03	2353
4429	1.4429	S31653	316S63	Z3 CND 17-12 Az	2375
4571	1.4571	316Ti	320S31	Z6 CNDT 17-12	2350

## Typical analysis of all-weld metal (Wt-%)

C	Si	Mn	Cr	Ni	Mo
0,02	0,8	0,7	18,0	12,0	2,8

## Mechanical properties of all-weld metal

Heat Treatment	Yield strength 0,2%	Tensile strength	Elongation ( $L_0=5d_0$ )	Impact values in J CVN		
	MPa	MPa	%	+20°C:	-40°C:	-196°C:
untreated	460	590	36	60	55	27

## Operating data

	Polarity = + / -
--	------------------

Dimensions (mm)	Amperage A
1,6	25-50
2,0	30-60
2,5	45-80
3,25	70-120
4,0	90-160
5,0	150-220

**Classifications**

high-alloyed

EN ISO 3581-A:

AWS A5.4:

E 19 12 3 L R

E316L-17

**Characteristics and field of use**

Avesta 316L/SKR-2D is a Cr-Ni-Mo high recovery electrode for welding 1.4436/ASTM 316 type stainless steels. The 2D type electrodes provide a metal recovery of about 150%, giving a high deposition rate and improved productivity in horizontal butt and overlay welding.

**Base materials**

For welding steels such as					
Outokumpu	EN	ASTM	BS	NF	SS
4436	1.4436	316	316S33	Z7 CND 18-12-03	2343
4432	1.4432	316L	316S13	Z3 CND 17-12-03	2353
4429	1.4429	S31653	316S63	Z3 CND 17-12 Az	2375
4571	1.4571	316Ti	320S31	Z6 CNDT 17-12	2350

**Typical analysis of all-weld metal (Wt-%)**

C	Si	Mn	Cr	Ni	Mo
0,03	0,8	0,8	18,0	11,7	2,8

**Mechanical properties of all-weld metal**

Heat Treatment	Yield strength	Tensile strength	Elongation	Impact values	
	0,2%		( $L_0=5d_0$ )	in J CVN	
	MPa	MPa	%	+20°C:	-40°C:
untreated	435	575	37	65	55

**Operating data**

Polarity = + / -

Dimensions (mm)	Amperage A
2,5	60-90
3,25	80-130
4,0	110-170
5,0	170-230

## Classifications

high-alloyed

EN ISO 3581-A:

AWS A5.4:

E 19 12 3 L R

E316L-17

## Characteristics and field of use

Avesta 316L/SKR-4D is a thin-coated, rutileacid type electrode specially developed for welding thin-walled pipes and sheets in 1.4436/ASTM 316 type steel, mainly in the chemical process and papermaking industries. It is highly suitable for welding in restrained positions and under difficult site conditions, where it offers considerably higher productivity than manual TIG-welding. It is also recommended for root runs and multi-pass welds in general fabrication of ASTM 316-type stainless steels in all material thicknesses. Pipe welding can be performed in several different ways. One possibility is to start welding in the overhead position (1), followed by vertical-down on both sides from the 12 o'clock position (2 and 3). Another possibility is to start at the 7 o'clock position and weld vertical up to the 11 o'clock position on both sides. This requires an inverter power source with a remote control. To bridge large root gaps DC- is often preferred.

## Base materials

For welding steels such as					
Outokumpu	EN	ASTM	BS	NF	SS
4436	1.4436	316	316S33	Z7 CND 18-12-03	2343
4432	1.4432	316L	316S13	Z3 CND 17-12-03	2353
4429	1.4429	S31653	316S63	Z3 CND 17-12 Az	2375
4571	1.4571	316Ti	320S31	Z6 CNDT 17-12	2350

## Typical analysis of all-weld metal (Wt-%)

C	Si	Mn	Cr	Ni	Mo
0,02	0,8	0,7	18,2	12,2	2,6

## Mechanical properties of all-weld metal

Heat Treatment	Yield strength 0,2%	Tensile strength	Elongation ( $L_0=5d_0$ )	Impact values in J CVN	
	MPa	MPa	%	+20°C:	-20°C:
untreated	480	590	34	60	55

## Operating data



Polarity = + / -

Dimensions (mm)	Amperage A
1,6	15-40
2,0	25-55
2,5	30-85
3,25	45-110

**Classifications**

high-alloyed

EN ISO 3581-A:

AWS A5.4:

E 19 12 3 L R

E316L-17

**Characteristics and field of use**

Avesta 316L/SKR-PW is a Cr-Ni-Mo electrode with a coating optimised for the vertical-up and overhead position welding of 1.4436/ASTM 316 type stainless steels. Thanks to the sharp and concentrated arc, PW electrodes are extremely suitable for maintenance and repair welding, especially when joint surfaces are not particularly clean.

**Base materials**

For welding steels such as					
Outokumpu	EN	ASTM	BS	NF	SS
4436	1.4436	316	316S33	Z7 CND 18-12-03	2343
4432	1.4432	316L	316S13	Z3 CND 17-12-03	2353
4429	1.4429	S31653	316S63	Z3 CND 17-12-Az	2375
4571	1.4571	316Ti	320S31	Z6 CNDT 17-12	2350

**Typical analysis of all-weld metal (Wt-%)**

C	Si	Mn	Cr	Ni	Mo
0,02	0,7	1,0	18,5	12,0	2,8

**Mechanical properties of all-weld metal**

Heat Treatment	Yield strength 0,2%	Tensile strength	Elongation ( $L_0=5d_0$ )	Impact values in J CVN	
	MPa	MPa	%	+20°C:	-40°C:
untreated	455	590	36	60	60

**Operating data**

Polarity = + / -

Dimensions (mm)	Amperage A
1,6	20-45
2,0	25-60
2,5	35-80
3,25	60-120
4,0	100-160
5,0	160-220

**Classifications**

high-alloyed

EN ISO 3581-A:

AWS A5.4:

E 19 12 3 LR 3 2

E316L-17

**Characteristics and field of use**

Low carbon, core wire alloyed, austenitic stick electrode with rutile coating. For application in all branches of industry where same-type steels, including higher-carbon steels and ferritic 13% chrome steels are welded. Special fine welding properties, excellent welding with AC power and a high resistance to hot cracking in the weld metal are features of this product. Resists intergranular corrosion up to +400 C.

**Base materials**

1.4401 X5CrNiMo17-12-2, 1.4404 X2CrNiMo17-12-2, 1.4435 X2CrNiMo18-14-3, 1.4436 X3CrNiMo17-13-3, 1.4571 X6CrNiMoTi17-12-2, 1.4580 X6CrNiMoNb17-12-2, 1.4583 X10CrNiMoNb18-12, 1.4409 GX2CrNiMo19-11-2 NS S31603, S31653; AISI 316L, 316Ti, 316Cb

**Typical analysis of all-weld metal (Wt-%)**

C	Si	Mn	Cr	Ni	Mo
0,03	0,8	0,8	18,8	11,5	2,7

**Mechanical properties of all-weld metal**

Heat Treatment	Yield strength 0,2%	Tensile strength	Elongation ( $L_0=5d_0$ )	Impact values in J CVN	
	MPa	MPa	%	+20°C:	-120°C:
untreated	460	600	36	90	≥ 32

**Operating data**

Polarity = + / -

**Dimensions (mm)**
**Amperage A**

1,5 x 250	25-40
2,0 x 300	40-60
2,5 x 250/350	50-90
3,2 x 350	80-120
4,0 x 350/450	110-160
5,0 x 450	140-200

**Approvals and certificates**

TÜV-D (0773.), DB (30.014.14), ABS (E 316L-17), DNV (316L), GL (4571), LR (316Lm), Statoil, VUZ, SEPROZ, CE, CWB, NAKS (Ø3.2 mm; Ø4.0 mm)

**Similar alloy filler metals**

Stick electrode:	FOX EAS 4 M FOX EAS 4 M-VD FOX EAS 4 M-TS FOX EAS 4 M (LF)	Flu cored wire:	EAS 4 M-MC EAS 4 M-FD EAS 4 PW-FD EAS 4 PW-FD (LF)
TIG rod:	EAS 4 M-IG	Wire/flux combination:	EAS 4 M-UP/BB 202
Solid wire electrode:	EAS 4 M-IG (Si)		

# Thermanit GEW 316L-17

Stick electrode

## Classifications

high-alloyed

EN ISO 3581-A:

AWS A5.4:

E 19 12 3 L R 3 2

E316L-17

## Characteristics and field of use

Stainless; resistant to intercrystalline corrosion and wet corrosion up to 400 °C (752 °F). Corrosion resistant similar to matching low carbon and stabilized austenitic 18/8 CrNiMo steels/cast steel grades. For joining and surfacing applications with matching/similar – non stabilized and stabilized – austenitic CrNi(N) and CrNiMo(N) steels/cast steel grades.

## Base materials

TÜV certified parent metals 1.4583 – X10CrNiMoNb18-12 1.4429 – X2CrNiMoN17-13-3 S31653; AISI 316L, 316Ti, 316Cb

## Typical analysis of all-weld metal (Wt-%)

C	Si	Mn	Cr	Mo	Ni
0,04	0,9	0,8	19,0	2,8	12,5

## Mechanical properties of all-weld metal

Heat Treatment	Yield strength 0,2%	Tensile strength	Elongation ( $L_0=5d_0$ )	Impact values in J CVN	
	MPa	MPa	%	+20°C:	-105°C:
untreated	350	550	35	60	40

## Operating data



Polarity = + / -

## Dimensions (mm)

## Amperage A

2,0 x 300	40-60
2,5 x 350	50-90
3,2 x 350	80-120
4,0 x 350	110-160
5,0 x 450	140-200

## Approvals and certificates

TÜV (Certificate No. 00484), DB (Reg. form No. 30.132.14), GL, LRS, CWB



**Classifications**

high-alloyed

EN ISO 3581-A:

AWS A5.4:

E 19 12 3 Nb B 2 2

E318-15

**Characteristics and field of use**

Stabilised, core wire alloyed austenitic stick electrode with basic coating. For application in all branches of industry where same-type steels and ferritic 13% chrome steels are welded. The weld metal has high toughness. It is therefore preferred for welding thick cross sections. Very good position welding. Resists intergranular corrosion up to +400°C.

**Base materials**

1.4571 X6CrNiMoTi17-12-2, 1.4580 X6CrNiMoNb17-12-2, 1.4401 X5CrNiMo17-12-2, 1.4581 GX5CrNiMoNb19-11-2, 1.4437 GX6CrNiMo18-12, 1.4583 X10CrNiMoNb18-12, 1.4436 X3CrNiMo17-13-3 AISI 316L, 316Ti, 316Cb

**Typical analysis of all-weld metal (Wt-%)**

C	Si	Mn	Cr	Ni	Mo	Nb
0,03	0,4	1,3	18,8	11,8	2,7	+

**Mechanical properties of all-weld metal**

Heat Treatment	Yield strength 0,2%	Tensile strength	Elongation ( $L_0=5d_0$ )	Impact values in J CVN	
	MPa	MPa	%	+20°C:	-90°C:
untreated	490	660	31	120	≥ 32

**Operating data**

Polarity = +

Dimensions (mm)	Amperage A
2,5 x 300	50-80
3,2 x 350	80-110
4,0 x 350	110-140

**Approvals and certificates**

TÜV-D (0774.), DB (30.014.05), ABS (Cr17/20, Ni10/13), GL (4571), SEPROZ, CE

**Similar alloy filler metals**

Stick electrode:	FOX SAS 4-A	Flu cored wire:	SAS 4 -FD SAS 4 PW-FD
Solid wire electrode:	SAS 4-IG (Si)	Wire/flux combination:	SAS 4-UP/BB 202
TIG rod:	SAS 4-IG		

## Classifications

high-alloyed

EN ISO 3581-A:

AWS A5.4:

E 19 12 3 Nb R 3 2

E318-17

## Characteristics and field of use

Stabilised, core wire alloyed, austenitic stick electrode with rutile coating. For application in all branches of industry where same-type steels and ferritic 13% chrome steels are welded. Special fine welding properties, excellent welding with AC power and a high resistance to hot cracking in the weld metal are features of this product. Resists intergranular corrosion up to +400°C.

## Base materials

1.4571 X6CrNiMoTi17-12-2, 1.4580 X6CrNiMoNb17-12-2, 1.4401 X5CrNiMo17-12-2, 1.4581 GX5CrNiMoNb19-11-2, 1.4437 GX6CrNiMo18-12, 1.4583 X10CrNiMoNb18-12, 1.4436 X3CrNi-Mo17-13-3 AISI 316L, 316Ti, 316Cb

## Typical analysis of all-weld metal (Wt-%)

C	Si	Mn	Cr	Ni	Mo	Nb
0,03	0,8	0,8	19,0	12	2,7	+

## Mechanical properties of all-weld metal

Heat Treatment	Yield strength	Tensile strength	Elongation	Impact values	
	0,2%		( $L_0=5d_0$ )	in J CVN	
	MPa	MPa	%	+20°C:	-90°C:
untreated	490	640	32	60	≥ 32

## Operating data



Polarity = + / ~

Dimensions (mm)	Amperage A
2,0 x 300	40-60
2,5 x 250/350	50-90
3,2 x 350	80-120
4,0 x 350	110-160
5,0 x 450	140-200

## Approvals and certificates

TÜV-D (0777.), DB (30.014.07), LTSS, SEPROZ, CE, NAKS (Ø 2.5; 3.2; 4.0 mm)

## Similar alloy filler metals

Stick electrode:	FOX SAS 4	Flu cored wire:	SAS 4 -FD SAS 4 PW-FD
TIG rod:	SAS 4-IG	Wire/flux combination:	SAS 4-UP/BB 202
Solid wire electrode:	SAS 4-IG (Si)		

# Thermanit AW

Stick electrode

## Classifications

high-alloyed

EN ISO 3581-A:

AWS A5.4:

E 19 12 3 Nb R 3 2

E318-17

## Characteristics and field of use

Stainless; resistant to intercrystalline corrosion and wet corrosion up to 400 °C (752 °F). Corrosion resistant similar to matching stabilized CrNiMo steels. For joining and surfacing work with matching and similar stabilized and non stabilized austenitic CrNi(N)- and CrNiMo(N) steels and cast steel grades.

## Base materials

1.4583 – X10CrNiMoNb18-12; AISI 316L, 316Ti, 316Cb

## Typical analysis of all-weld metal (Wt-%)

C	Si	Mn	Cr	Mo	Ni	Nb
0,03	0,9	0,8	19,0	2,8	12,0	>10xC

## Mechanical properties of all-weld metal

Heat Treatment	Yield strength 0,2%	Tensile strength	Elongation ( $L_0=5d_0$ )	Impact values in J CVN
	MPa	MPa	%	at RT
untreated	400	550	30	60

## Operating data



Polarity = + / -

## Dimensions (mm)

## Amperage A

2,0 x 300	40-60
2,5 x 350	50-90
3,2 x 350	80-120
4,0 x 350	110-160
5,0 x 450	140-200

## Approvals and certificates

TÜV (Certificate No. 00607), DB (Reg. form No. 30.132.09)

## Classifications

high-alloyed

EN ISO 3581-A:

AWS A5.4:

E 19 9 Nb R

E347-17

## Characteristics and field of use

Avesta 347/MVNb is a Nb-stabilised Cr-Ni electrode for welding steels that are stabilised with titanium or niobium, such as 1.4541/ASTM 321. A stabilised weldment has improved high temperature properties, e.g. creep resistance, compared to low-carbon non-stabilised grades. Avesta 347/MVNb can also be used for the second layer (first layer 309 type) when cladding mild steel.

## Base materials

For welding steels such as					
Outokumpu	EN	ASTM	BS	NF	SS
4541	1.4541	321	321S31	Z6 CNT 18-10	2337
-	1.4550	347	347S31	Z6 CNNb 18-10	2338

## Typical analysis of all-weld metal (Wt-%)

C	Si	Mn	Cr	Ni	Nb
0,02	0,8	0,8	19,5	10,3	>=10xC

FN 7 - WRC-92

## Mechanical properties of all-weld metal

Heat Treatment	Yield strength 0,2%	Tensile strength	Elongation (L <sub>0</sub> =5d <sub>0</sub> )	Impact values in J CVN	
	MPa	MPa	%	+20°C:	-40°C:
untreated	470	620	35	60	45

## Operating data



Polarity = + / -

Dimensions (mm)	Amperage A
2,0	35-60
2,5	45-70
3,25	55-120
4,0	90-150
5,0	150-200

**Classifications** high-alloyed

EN ISO 3581-A:	AWS A5.4:	
E 19 9 Nb B 2 2	E347-15	

**Characteristics and field of use**

Stabilised, core wire alloyed austenitic stick electrode with basic coating. For application in all branches of industry where same-type steels and ferritic 13% chrome steels are welded. The weld metal has high toughness. It is therefore preferred for welding thick cross sections. Very good position welding. Cryogenic down to -196°C. Resists intergranular corrosion up to +400°C.

**Base materials**

1.4550 X6CrNiNb18-10, 1.4541 X6CrNiTi18-10, 1.4552 GX5CrNiNb19-11, 1.4301 X5CrNi18-10, 1.4312 GX10CrNi18-8, 1.4546 X5CrNiNb18-10, 1.4311 X2CrNiN18-10, 1.4306 X2CrNi19-11  
 AISI 347, 321,302, 304, 304L, 304LN, ASTM A296 Gr. CF 8 C, A157 Gr. C9, A320 Gr. B8C or D

**Typical analysis of all-weld metal (Wt-%)**

C	Si	Mn	Cr	Ni	Nb
0,03	0,4	1,3	19,8	10,2	+

**Mechanical properties of all-weld metal**

Heat Treatment	Yield strength 0,2%	Tensile strength	Elongation (L <sub>0</sub> =5d <sub>0</sub> )	Impact values in J CVN	
	MPa	MPa	%	+20°C:	-196°C:
untreated	470	640	36	110	≥ 32

**Operating data**

	Polarity = +
---	--------------

Dimensions (mm)	Amperage A
2,5 x 300	50-80
3,2 x 350	80-110
4,0 x 350	110-140

**Approvals and certificates**

TÜV-D (1282.), DB (30.014.04), ABS (Cr18/21, Ni8/11, TaNb.1.1), GL (4550), LTSS, SEPROZ, CE

**Similar alloy filler metals**

Stick electrode:	FOX SAS 2-A	Flu cored wire:	SAS 2-FD SAS 2 PW-FD
Solid wire electrode:	SAS 2-IG (Si)	Wire/flux combination:	SAS 2-UP/BB 202
TIG rod:	SAS 2-IG		

## Classifications

high-alloyed

EN ISO 3581-A:

AWS A5.4:

E 19 9 Nb R 3 2

E347-17

## Characteristics and field of use

Stabilised, core wire alloyed, austenitic stick electrode with rutile coating. For application in all branches of industry where same-type steels and ferritic 13% chrome steels are welded. Special fine welding properties, excellent welding with AC power and a high resistance to hot cracking in the weld metal are features of this product. Resists intergranular corrosion up to +400°C.

## Base materials

1.4550 X6CrNiNb18-10, 1.4541 X6CrNiTi18-10, 1.4552 GX5CrNiNb19-11, 1.4301 X5CrNi18-10, 1.4312 GX10CrNi18-8, 1.4546 X5CrNiNb18-10, 1.4311 X2CrNi18-10, 1.4306 X2CrNi19-11  
AISI 347, 321,302, 304, 304L, 304LN, ASTM A296 Gr. CF 8 C, A157 Gr. C9, A320 Gr. B8C or D

## Typical analysis of all-weld metal (Wt-%)

C	Si	Mn	Cr	Ni	Nb
0,03	0,8	0,8	19,5	10,0	+

## Mechanical properties of all-weld metal

Heat Treatment	Yield strength	Tensile strength	Elongation	Impact values	
	0,2%		( $L_0=5d_0$ )	in J CVN	
	MPa	MPa	%	+20°C:	-120°C:
untreated	470	620	35	70	≥ 32

## Operating data



Polarity = + / -

## Dimensions (mm)

## Amperage A

2,0 x 300	40-60
2,5 x 250/350	50-90
3,2 x 350	80-120
4,0 x 350	110-160
5,0 x 450	140-200

## Approvals and certificates

TÜV-D (1105.), DB (30.014.06), ABS (347-17), GL (4550), LTSS, VUZ, SEPROZ, CE, NAKS (Ø2.5; Ø3.2; Ø4.0)

## Similar alloy filler metals

Stick electrode:	FOX SAS 2	Flu cored wire:	SAS 2-FD SAS 2 PW-FD
Solid wire electrode:	SAS 2-IG (Si)	Wire/flux combination:	SAS 2-UP/BB 202
TIG rod:	SAS 2-IG		

### Classifications

high-alloyed

EN ISO 3581-A:

AWS A5.4:

E 13 4 B 6 2

E410NiMo-15

### Characteristics and field of use

Basic coated stick electrode for same-type corrosion-resistant, martensitic and martensitic-ferritic rolled, forged and cast steels. Used in the construction of water turbines and compressors, and in the construction of steam power stations. Resistant to water, steam and seawater atmospheres. Thanks to optimisation of the alloy composition, the weld metal, in spite of its high tensile strength, achieves exceptional extension and toughness figures, as well as a high resistance to cracking. The weld metal is also characterised by an extremely low hydrogen content (HD ≤ 5 ml/100 g). Exceptional slag detachability and seam cleanliness. Deposition efficiency about 130%.

### Base materials

1.4317 GX4CrNi13-4, 1.4313 X3CrNiMo13-4, 1.4407 GX5CrNiMo13-4, 1.4414 GX4CrNiMo13-4  
ACI Gr. CA 6 NM, S41500

### Typical analysis of all-weld metal (Wt-%)

C	Si	Mn	Cr	Ni	Mo
0,035	0,3	0,5	12,2	4,5	0,5

### Mechanical properties of all-weld metal

Heat Treatment	Yield strength 0,2%	Tensile strength	Elongation (L <sub>0</sub> =5d <sub>0</sub> )	Impact values in J CVN		
				+20°C:	-20°C (t*):	-60°C (t*):
untreated	890	1090	12	32	55	50

\*tempered, 600 C/2 h/air

### Operating data



Polarity = +

### Dimensions (mm)

### Amperage A

2,5 x 350	60-90
3,2 x 450	90-130
4,0 x 450	120-170
5,0 x 450	160-220

### Approvals and certificates

TÜV-D (3232.), LTSS, SEPROZ, CE

### Similar alloy filler metals

Stick electrode:	FOX CN 13/4	TIG rod:	CN 13/4-IG
SUPRA Wire/flux combination:	CN 13/4-UP/BB 203	Flu cored wire:	CN 13/4-MC
Solid wire electrode:	CN 13/4-IG CN 13/4-MC (F)		

**Classifications**

high-alloyed

EN ISO 3581-A:

AWS A5.4:

E 18 8 Mn B 2 2

E307-15 (mod.)

**Characteristics and field of use**

Core wire alloyed electrode with basic coating for joints between dissimilar steels, steels that are hard to weld and 14% Mn steels. Well suited for tough intermediate layers in case of hardfacing. Properties of the weld metal: suitable for strain-hardening, very good cavitation resistance, crack resistant, resistant to thermal shock, resistant to scaling up to +850 °C, little or no tendency to sigma-phase embrittlement above 500 °C, cryogenic down to -110 °C. Heat treatment is possible. Consultation with the manufacturer is required for operating temperatures above +650°C. Exceptional toughness of the weld metal even at high dilution levels. Good position weldability. It is approved for welding armour plates.

**Base materials**

high-strength, unalloyed and alloyed structural, quenched and tempered and armour steels among themselves or among each other; unalloyed and alloyed boiler or structural steels with high-alloyed Cr and Cr-Ni steels; heat-resistant steels up to +850 °C; austenitic manganese steels together and with other steels; cryogenic plate and pipe steels together with cryogenic austenitic materials.

**Typical analysis of all-weld metal (Wt-%)**

C	Si	Mn	Cr	Ni
0,09	0,7	6,5	18,6	8,8

**Mechanical properties of all-weld metal**

Heat Treatment	Yield strength	Tensile strength	Elongation	Impact values	
	0,2%		( $L_0=5d_0$ )	in J CVN	
	MPa	MPa	%	+20°C:	-110°C:
untreated	460	650	35	90	≥ 32

**Operating data**

Polarity = +

**Dimensions (mm)**
**Amperage A**

2,5 x 300	55-75
3,2 x 350	80-100
4,0 x 350	100-130
5,0 x 450	140-170
6,0 x 450	160-200

**Approvals and certificates**

TÜV-D (06786.), DNV (E 18 8 MnB), GL (4370), LTSS, SEPROZ, VG 95132, CE, (FOX A 7 CN: TÜV-D (00022.))

**Similar alloy filler metals**

Stick electrode:	FOX A 7-A	TIG rod:	A 7 CN-IG
Solid wire electrode:	A 7-IG / A 7 CN-IG*	Metal powder wire:	A 7-MC
Flu cored wire:	A 7-FD A 7 PW-FD	Wire/flux combination:	A 7CN-UP/BB 203



## Classifications

high-alloyed

EN ISO 3581-A:

AWS A5.4:

E 18 8 Mn B 2 2

E307-15 (mod.)

## Characteristics and field of use

Stainless. Resistant to scaling up to 850 °C (1562 °F). No adequate resistance against sulphurous combustion gases at temperatures above 500 °C (932 °F). For joining and surfacing applications with heat resistant Cr steels/cast steel grades and heat resistant austenitic steels/cast steel grades. Well suited to fabricating austenitic-ferritic joints – max. application temperature 300 °C (572 °F). For joining unalloyed/low alloy or Cr steels/cast steel grades to austenitic steels. Low heat input required in order to avoid brittle martensitic transition zones. Not suitable for the welding of buffer layer, clad sheet metal or cladding applications.

## Base materials

TÜV certified parent metal 1.4583 – X10CrNiMoNb18-12 as well as included parent metals combined with ferritic steels up to fine grained structural steels grade StE460 (P 460 N); high tensile, unalloyed and alloyed structural, quenched and tempered, and armour steels, same parent metal or in combination; unalloyed and alloyed boiler or structural steels with highalloyed Cr and CrNi steels; heat resistant steels up to 850 °C (1562 °F); austenitic high manganese steel with matching and other steels. Cryogenic sheet metals and pipe steels in combination with austenitic parent metals.

## Typical analysis of all-weld metal (Wt-%)

C	Si	Mn	Cr	Ni	N
0,10	0,6	7,0	18,5	8,0	0,12

## Mechanical properties of all-weld metal

Heat Treatment	Yield strength 0,2%	Tensile strength	Elongation ( $L_0=5d_0$ )	Impact values in J CVN
	MPa	MPa	%	at RT
untreated	350	600	40	100

## Operating data



Polarity = +

## Dimensions (mm)

## Amperage A

2,5 x 300

55-75

3,2 x 350

70-110

4,0 x 350

85-130

5,0 x 450

140-170

## Approvals and certificates

TÜV (Certificate No. 05650), DB (Reg. form No. 30.132.01)

## Classifications

high-alloyed

EN ISO 3581-A:

AWS A5.4:

E Z18 9 MnMo R 3 2

E307-16 (mod.)

## Characteristics and field of use

Core wire alloyed electrode with rutile-basic coating for joints between dissimilar steels, steels that are hard to weld and 14% Mn steels. Well suited for tough intermediate layers in case of hardfacing. Properties of the weld metal: suitable for strain-hardening, very good cavitation resistance, crack resistant, resistant to thermal shock, resistant to scaling up to +850 °C, little tendency to sigma-phase embrittlement above 500°C. Heat treatment is possible. Consultation with the manufacturer is recommended for operating temperatures above +650°C. Exceptional toughness of the weld metal even at high dilution levels with hard-to-weld steels or when subject to thermal shock. Cryogenic down to -100 °C. Stable arc even with AC power.

## Base materials

high-strength, unalloyed and alloyed structural, quenched and tempered and armour steels among themselves or among each other; unalloyed and alloyed boiler or structural steels with high-alloyed Cr and Cr-Ni steels; heat-resistant steels up to +850 °C; austenitic manganese steels together and with other steels; cryogenic plate and pipe steels together with cryogenic austenitic materials.

## Typical analysis of all-weld metal (Wt-%)

C	Si	Mn	Cr	Ni	Mo
0,10	1,5	4,0	19,5	8,5	0,7

## Mechanical properties of all-weld metal

Heat Treatment	Yield strength	Tensile strength	Elongation	Impact values	
	0,2%		( $L_0=5d_0$ )	in J CVN	
	MPa	MPa	%	+20°C:	-100°C:
untreated	520	720	35	75	≥ 32

## Operating data



Polarity = + / ~

## Dimensions (mm)

Dimensions (mm)	Amperage A
2,5 x 350	60-80
3,2 x 350	80-110
4,0 x 350	110-140
5,0 x 450	140-170

## Approvals and certificates

TÜV-D (09101.), SEPROZ, NAKS, CE

## Similar alloy filler metals

Stick electrode:	FOX A 7 / FOX A 7 CN*	Solid wire electrode:	A 7-IG / A 7 CN-IG*
TIG rod:	A 7 CN-IG	Metal powder wire:	A 7-MC
Flu cored wire:	A 7-FD A 7 PW-FD	Wire/flux combination:	A 7 CN-UP/BB 203

\* Brand name German

## Classifications

high-alloyed

EN ISO 3581-A:

AWS A5.4:

E 18 8 Mn R 1 2

E307-16 (mod.)

## Characteristics and field of use

Stainless. Resistant to scaling up to 850 °C (1562 °F). No adequate resistance against sulphurous combustion gases at temperatures above 500 °C (932 °F). For joining and surfacing applications with heat resistant Cr steels/cast steel grades and heat resistant austenitic steels/cast steel grades. Well suited to fabricating austenitic-ferritic joints – max. application temperature 300 °C (572 °F). For joining unalloyed/low alloy or Cr steels/ cast steel grades to austenitic steels. Low heat input required in order to avoid brittle martensitic transition zones. Not suitable for the welding of buffer layer, clad sheet metal or cladding applications.

## Base materials

1.4583 – X10CrNiMoNb18-12 as well as included parent metals combined with ferritic steels up to fine grained structural steels grade StE 355 (P355N); high tensile, unalloyed and alloyed structural, quenched and tempered, and armour steels, same parent metal or in combination; unalloyed and alloyed boiler or structural steels with highalloyed Cr and CrNi steels; heat resistant steels up to 850 °C (1562 °F); austenitic high manganese steel with matching and other steels. Cryogenic sheet metals and pipe steels in combination with austenitic parent metals.

## Typical analysis of all-weld metal (Wt-%)

C	Si	Mn	Cr	Ni	N
0,10	0,6	7,0	18,5	8,0	0,08

## Mechanical properties of all-weld metal

Heat Treatment	Yield strength 0,2%	Tensile strength	Elongation ( $L_0=5d_0$ )	Impact values in J CVN
	MPa	MPa	%	at RT
untreated	350	600	40	70

## Operating data



Polarity = + / -

## Dimensions (mm)

## Amperage A

2,0 x 300	45-60
2,5 x 300	55-70
3,2 x 350	65-105
4,0 x 350	110-140
5,0 x 450	150-200

## Approvals and certificates

TÜV (Certificate No. 01235), DB (Reg. form No. 30.132.08) GL LR

**Classifications** high-alloyed

EN ISO 3581-A:	AWS A5.4:	
E 20 10 3 R 3 2	E308Mo-17 (mod.)	

**Characteristics and field of use**

Core wire alloyed, rutile coated stick electrode with basic components for ferrite-austenite joints and intermediate layers in weld cladding. Operating temperature between -80 °C and +300 °C. Very good welding in all positions except for vertical down. Good fine welding properties and extremely good AC weldability.

**Base materials**

high-strength, unalloyed and alloyed structural, quenched and tempered and armour steels among themselves or among each other; unalloyed and alloyed boiler or structural steels with high-alloyed Cr and Cr-Ni steels; austenitic manganese steels together and with other steels.

**Typical analysis of all-weld metal (Wt-%)**

C	Si	Mn	Cr	Ni	Mo
0,04	0,7	0,8	20,2	10,3	3,2

**Mechanical properties of all-weld metal**

Heat Treatment	Yield strength	Tensile strength	Elongation	Impact values	
	0,2%		( $L_0=5d_0$ )	in J CVN	
	MPa	MPa	%	+20°C:	-80°C:
untreated	520	700	28	70	≥ 32

**Operating data**

Polarity = + / ~

Dimensions (mm)	Amperage A
2,5 x 250	50-85
3,2 x 350	75-115
4,0 x 350	110-160
5,0 x 450	160-200

**Approvals and certificates**

TÜV-D (1086.), DB (30.014.03), ABS (Cr18/20, Ni8/10Mo), GL (4331), LR (V4-P12), SEPROZ, CE

**Similar alloy filler metals**

TIG rod:	CN 19/9 M-IG	Solid wire electrode:	CN 19/9 M-IG
----------	--------------	-----------------------	--------------

## Classifications

high-alloyed

EN ISO 3581-A:

AWS A5.4:

E 20 25 5 Cu N L R

E385-17

## Characteristics and field of use

Avesta 904L is a high-alloyed fully austenitic Cr-Ni-Mo-Cu electrode designed for welding 1.4539/ASTM 904L type steels. It can also be used for welding 1.4404/ASTM 316 components where a ferrite free weld is required, e.g. in cryogenic or non-magnetic applications. The weld metal has a very good impact toughness at low temperatures. To minimise the risk of hot cracking when welding fully austenitic steels, heat input and interpass temperature must be low and there must be as little dilution as possible from the parent metal.

## Base materials

For welding steels such as					
Outokumpu	EN	ASTM	BS	NF	SS
904L	1.4539	904L	904S13	Z2 NCDU 25-20	2562

Also for welding similar steels of the 20-25 CrNiMoCu-type.

## Typical analysis of all-weld metal (Wt-%)

C	Si	Mn	Cr	Ni	Mo	Cu
0,02	0,7	1,2	20,5	25,0	4,5	1,5

## Mechanical properties of all-weld metal

Heat Treatment	Yield strength 0,2%	Tensile strength	Elongation ( $L_0=5d_0$ )	Impact values in J CVN		
	MPa	MPa	%	+20°C:	-40°C:	-196°C:
untreated	400	600	34	70	60	50

## Operating data



Polarity = + / -

## Dimensions (mm)

## Amperage A

2,5

35-75

3,25

55-110

4,0

100-150

5,0

140-190

**BÖHLER FOX CN 20/25 M-A**

Stick electrode

**Classifications**

high-alloyed

EN ISO 3581-A:

AWS A5.4:

E 20 25 5 Cu N L R 3 2

E385-17 (mod.)

**Characteristics and field of use**

Core wire alloyed, rutile coated stick electrode of type 904 L with above-average Mo content and very high pitting resistance equivalent (PREN  $\geq 45$ ) of the weld metal (according to %Cr+3.3x%-Mo+30x%N). Particularly used in the production of sulphuric and phosphoric acids in the cellulose industry, in flue gas desulphurisation plants and also in the fertiliser industry, petrochemical industry, fatty acid processing, the manufacture of acetic and formic acid, seawater desalination, in pickling plants and for heat exchangers that are operated with sea or brackish water. The weld metal is fully austenitic, and has distinct resistance to pitting and crevice corrosion in media containing chlorides, high resistance to sulphuric, phosphoric, acetic and formic acid, as well as to sea water and brackish water. As a result of the low C content of the weld metal, the risk of intergranular corrosion is also avoided, whereas the high Ni content, in comparison with conventional 18/8 CrNi weld metal types, provides very good resistance to stress corrosion cracking. As a result of the high over-alloying with Mo as compared to 1.4539 or UNS N08904 it is possible to compensate for the demonstrably high segregation rate of CrNi weld metals with a high Mo content. BÖHLER FOX CN 20/25 M-A has outstanding welding properties, and is easily handled in every position except for vertical down. The electrode exhibits good slag detachability, along with clean, finely rippled weld seams.

**Base materials**

same-type high-Mo content Cr-Ni steels 1.4539 X1NiCrMoCu25-20-5, 1.4439 X2CrNiMoN17-13-5, 1.4537 X1CrNiMoCuN25-25-5 UNS N08904, S31726

**Typical analysis of all-weld metal (Wt-%)**

C	Si	Mn	Cr	Ni	Mo	Cu	N	PRE <sub>N</sub>
=0,03	0,7	1,7	20,3	25,0	6,2	1,5	0,17	=45

**Mechanical properties of all-weld metal**

Heat Treatment	Yield strength 0,2%	Tensile strength	Elongation ( $L_0=5d_0$ )	Impact values in J CVN	
	MPa	MPa	%	+20°C:	-196°C:
untreated	410	640	34	70	$\geq 32$

**Operating data**

Polarity = + / -

**Dimensions (mm)**

2,5 x 300

**Amperage A**

50-80

3,2 x 350

80-110

4,0 x 350

100-135

**Approvals and certificates**

TÜV-D (6634.), SEPROZ, CE

**Similar alloy filler metals**

Stick electrode:

FOX CN 20/25 M

TIG rod:

CN 20/25 M-IG

Solid wire electrode:

CN 20/25 M-IG (Si)

## Classifications

high-alloyed

EN ISO 3581-A:

E 21 10 R

## Characteristics and field of use

Avesta 253 MA is primarily designed for welding the high temperature stainless steel Outokumpu 253 MA, used for furnaces, combustion chambers and burners. Both the steel and filler metal offers excellent resistance to oxidation up to 1100°C. The chemical composition of Avesta 253 MA is balanced to give a crack resistant weld metal. The steel often forms a rather thick oxide in welding or hot rolling and oxidized plates and welds must be brushed or ground clean before welding.

## Base materials

For welding steels such as	EN	ASTM	BS	NF	SS
Outokumpu	EN	ASTM	BS	NF	SS
253 MA	1.4835	S30815	-	-	2368
153 MA	1.4818	S30415	-	-	2372

## Typical analysis of all-weld metal (Wt-%)

C	Si	Mn	Cr	Ni	N
0,08	1,5	0,7	22,0	10,5	0,18

## Mechanical properties of all-weld metal

Heat Treatment	Yield strength 0,2%	Tensile strength	Elongation ( $L_0=5d_0$ )	Impact values in J CVN
	MPa	MPa	%	
untreated	535	725	37	+20°C: 60

## Operating data



Polarity = + / -

Dimensions (mm)	Amperage A
2,0	45-65
2,5	60-80
3,25	70-110
4,0	100-140
5,0	150-200

# UTP 2133 Mn

Stick electrode

## Classifications

high-alloyed

EN ISO 3581-A:

EZ 21 33 B 4 2

## Characteristics and field of use

UTP 2133 Mn is suitable for joining and surfacing of heat-resistant steels and cast steels of the same or of similar nature. It is used for operating temperatures up to 1050° C in carburized low-sulphur combustion gas, e. g. in petrochemical plants.

## Base materials

1.4876 X10 NiCrAlTi 32 20 UNS N 088001.4859 G- X10 NiCrNb 32 20 1.4958 X 5 NiCrAlTi 31 20 UNS N 08810 1.4959 X 8 NiCrAlTi 31 21 UNS N 08811

## Typical analysis of all-weld metal (Wt-%)

C	Si	Mn	Cr	Ni	Nb	Fe
0,14	0,5	4,5	21,0	33,0	1,3	balance

## Mechanical properties of all-weld metal

Heat Treatment	Yield strength 0,2%	Tensile strength	Elongation ( $L_0=5d_0$ )	Impact values in J CVN
	MPa	MPa	%	at RT
untreated	410	600	25	70

## Operating data



Polarity = +

## Dimensions (mm)

2,5 x 300

3,2 x 350

4,0 x 400

## Amperage A

50-75

70-110

90-140

## Approvals and certificates

TÜV (No. 07713)



## Classifications

high-alloyed

EN ISO 3581-A:

AWS 5.4:

E 22 9 3 N L B

E2209-15

## Characteristics and field of use

Avesta 2205 basic provides better impact properties and somewhat better position welding properties compared to the 3D type. It is primarily designed for welding duplex steels of the 2205 type. The weldability of duplex steels is excellent, but the welding should be adapted to the base material, considering fluidity, joint design, heat input etc.

## Base materials

For welding steels such as					
Outokumpu	EN	ASTM	BS	NF	SS
2205	1.4462	S32205	318S13	Z3 CND 22-05 Az	2377

## Typical analysis of all-weld metal (Wt-%)

C	Si	Mn	Cr	Ni	Mo	N
0,03	0,5	1,2	23,5	8,9	3,0	0,16

Ferrite 45 FN WRC-92

## Mechanical properties of all-weld metal

Heat Treatment	Yield strength 0,2%	Tensile strength	Elongation ( $L_0=5d_0$ )	Impact values in J CVN	
	MPa	MPa	%	+20°C:	-40°C:
untreated	645	840	26	90	75

## Operating data



Polarity = + / -

Dimensions (mm)	Amperage A
2,5	45-75
3,25	70-110
4,0	100-140

## Classifications

high-alloyed

EN ISO 3581-A:	AWS A5.4:	
E 22 9 3 N L R	E2209-17	

## Characteristics and field of use

Avesta 2205 is primarily designed for welding duplex stainless steels such as 2205. The weldability of duplex steels is excellent, but the welding should be adapted to the base material, considering fluidity, joint design, heat input etc.

## Base materials

For welding steels such as					
Outokumpu	EN	ASTM	BS	NF	SS
2205	1.4462	S32205	318S13	Z3 CND 22-05 Az	2377

## Typical analysis of all-weld metal (Wt-%)

C	Si	Mn	Cr	Ni	Mo	N
0,02	0,8	0,7	22,6	9,4	3,0	0,16

## Mechanical properties of all-weld metal

Heat Treatment	Yield strength 0,2%	Tensile strength	Elongation (L <sub>0</sub> =5d <sub>0</sub> )	Impact values in J CVN	
	MPa	MPa	%	+20°C:	-46°C:
untreated	635	810	25	50	35

## Operating data



Polarity = + / -

Dimensions (mm)	Amperage A
2,0	30-60
2,5	45-80
3,25	70-120
4,0	90-160
5,0	150-220

**Classifications** high-alloyed

EN ISO 3581-A:	AWS A5.4:	
E 22 9 3 N L R	E2209-17	

**Characteristics and field of use**

Avesta 2205-PW is a duplex electrode with a coating optimized for the vertical-up and overhead position welding of duplex 2205 type steel. The weldability of duplex steels is excellent, but the welding should be adapted to the base material, considering fluidity, joint design, heat input etc. Thanks to the sharp and concentrated arc, PW electrodes are extremely suitable for maintenance and repair welding, especially when joint surfaces are not particularly clean.

**Base materials**

For welding steels such as					
Outokumpu	EN	ASTM	BS	NF	SS
2205	1.4462	S32205	318S13	Z3 CND 22-05 Az	2377

**Typical analysis of all-weld metal (Wt-%)**

C	Si	Mn	Cr	Ni	Mo	N
0,02	0,8	0,8	23,0	9,5	3,1	0,18

Ferrite 35 FN WRC-92

**Mechanical properties of all-weld metal**

Heat Treatment	Yield strength 0,2%	Tensile strength	Elongation (L <sub>0</sub> =5d <sub>0</sub> )	Impact values in J CVN	
				+20°C:	-46°C:
untreated	680	860	25	55	35

**Operating data**



Polarity = + / -

Dimensions (mm)	Amperage A
2,5	50-80
3,25	70-110
4,0	100 - 160
5,0	160 - 220

## Classifications

high-alloyed

EN ISO 3581-A:

AWS A5.4:

E 22 9 3 N L R 3 2

E2209-17

## Characteristics and field of use

Core wire alloyed, rutile coated stick electrode for welding ferritic-austenitic duplex steels such as 1.4462, UNS 31803. Used primarily in the fields of offshore engineering and chemical industry. In addition to increased strength and toughness, the weld metal has an exceptional resistance to stress corrosion cracking due to the high proportion of ferrite. Good pitting resistance according to ASTM G48 / method A. The 2.0 and 2.5 mm dimensions when used at the DC negative pole are particularly suitable for vertical up welding of pipes in the root and in the subsequent passes, which is necessary, for instance, in oilfield engineering. Good AC weldability. All dimensions suitable for position welding.

## Base materials

same-type duplex steels as well as similar-alloy, ferritic-austenitic materials of increased strength 1.4462 X2CrNiMoN22-5-3, 1.4362 X2CrNiN23-4, 1.4462 X2CrNiMoN22-5-3 with 1.4583 X10CrNiMoNb18-12, 1.4462 X2CrNiMoN22-5-3 with P235GH/ P265GH, S255N, P295GH, S355N, 16Mo3 UNS S31803, S32205

## Typical analysis of all-weld metal (Wt-%)

C	Si	Mn	Cr	Ni	Mo	N	PRE <sub>N</sub>
=0,03	0,8	0,9	22,6	9,0	3,1	0,17	=35

## Mechanical properties of all-weld metal

Heat Treatment	Yield strength 0,2%	Tensile strength	Elongation (L <sub>0</sub> =5d <sub>0</sub> )	Impact values in J CVN		
				+20°C:	-10°C:	-20°C:
untreated	650	820	25	55	50	≥ 32

## Operating data



Polarity = ± / ~

## Dimensions (mm)

2,5 x 350

3,2 x 350

4,0 x 350

5,0 x 450

## Amperage A

40-75

70-120

110-160

150-200

## Approvals and certificates

TÜV-D (3636.), ABS (E 22 09-17), DNV (Duplex), GL (4462), LR (X), RINA (2209), Statoil, SE-PROZ, CE

## Similar alloy filler metals

Stick electrode:	FOX CN 22/9 N-B	Solid wire electrode:	CN 22/9 N-IG
TIG rod:	CN 22/9 N-IG	Flu cored wire:	CN 22/9 N-FD CN 22/9 PW-FD
Wire/flux combination:	CN 22/9 N-UP/BB 202		

## Classifications

high-alloyed

EN ISO 3581-A:

E 23 7 N L R

## Characteristics and field of use

Avesta 2304 is primarily designed for welding the duplex stainless steel Outokumpu 2304® and similar grades. Thanks to the low molybdenum content, corrosion resistance in nitric acid containing environments is very good. The weldability of duplex steels is excellent but the welding should be adapted to the base material, considering fluidity, joint design, heat input etc.

## Base materials

For welding steels such as					
Outokumpu	EN	ASTM	BS	NF	SS
2304	1.4362	S32304	-	-	2327

## Typical analysis of all-weld metal (Wt-%)

C	Si	Mn	Cr	Ni	Mo	N
0,02	0,8	0,8	24,8	9,0	0,2	0,12

Ferrite 40 FN WRC-92

## Mechanical properties of all-weld metal

Heat Treatment	Yield strength 0,2%	Tensile strength	Elongation ( $L_0=5d_0$ )	Impact values in J CVN	
	MPa	MPa	%	+20°C:	-40°C:
untreated	640	780	23	40	30

## Operating data



Polarity = + / -

Dimensions (mm)	Amperage A
2,5	50-80
3,25	80-120
4,0	100-160

## Classifications

high-alloyed

EN ISO 3581-A:

E 23 7 N L R

## Characteristics and field of use

Avesta LDX 2101 is designed for welding the ferritic-austenitic (duplex) stainless steel Outokumpu LDX 2101®. LDX 2101 is a "lean duplex" steel with excellent strength and medium corrosion resistance. The steel is used in many various applications such as bridges, process equipment in desalination, pressure vessel in the pulp/paper industry and transport and storage tanks for chemicals. To ensure the right ferrite balance in the weld metal, Avesta LDX 2101 is over-alloyed with respect to nickel. The weldability of duplex steels is excellent but the welding should be adapted to the base material, considering fluidity, joint design, heat input etc.

## Base materials

For welding steels such as					
Outokumpu	EN	ASTM	BS	NF	SS
LDX 2101	1.4162	S32101	-	-	-

## Typical analysis of all-weld metal (Wt-%)

C	Si	Mn	Cr	Ni	Mo	N
0,04	0,8	0,7	23,5	7,0	0,3	0,14

Ferrite 45 FN WRC-92

## Mechanical properties of all-weld metal

Heat Treatment	Yield strength 0,2%	Tensile strength	Elongation ( $L_0=5d_0$ )	Impact values in J CVN	
	MPa	MPa	%	+20°C:	-40°C:
untreated	640	780	25	45	35

## Operating data



Polarity = + / -

## Dimensions (mm) Amperage A

2,0	50-80
3,25	70-120
4,0	100-160

## Classifications

high-alloyed

EN ISO 3581-A:

AWS A5.4:

E 23 12 2 L R

E309MoL-17

## Characteristics and field of use

Avesta P5 is a high-alloyed low carbon electrode designed for welding dissimilar joints between stainless and mild or low-alloy steels. It can also be used for overlay welding, providing an 18 Cr 8 Ni 2 Mo deposit from the very first layer. It can also be used for welding highstrength steels.

## Base materials

For welding steels such as					
Outokumpu	EN	ASTM	BS	NF	SS
High-alloyed low carbon electrode for surfacing unalloyed steel, joint welding molybdenum alloyed stainless steel to unalloyed steel and for welding clad material.					

## Typical analysis of all-weld metal (Wt-%)

C	Si	Mn	Cr	Ni	Mo
0,02	0,8	0,8	22,5	13,5	2,5

Ferrite 20 FN WRC-92

## Mechanical properties of all-weld metal

Heat Treatment	Yield strength 0,2%	Tensile strength	Elongation ( $L_0=5d_0$ )	Impact values in J CVN	
	MPa	MPa	%	+20°C:	-40°C:
untreated	490	640	30	30	27

## Operating data

	Polarity = + / -
--	------------------

Dimensions (mm)	Amperage A
2,0	30-60
2,5	45-80
3,25	70-120
4,0	90-160
5,0	150-220

## Classifications

high-alloyed

EN ISO 3581-A:

AWS A5.4:

E 23 12 2 L R 3 2

E309LMo-17

## Characteristics and field of use

Low carbon, austenitic stick electrode with rutile coating. High crack resistance with hard-toweld materials, austenite-ferrite joints and weld claddings is achieved through the increased ferrite content (FN ~20) in the weld metal. Particularly good fine welding properties and excellent AC weldability characterise this product. For operating temperatures up to +300°C, for the first layer of weld claddings up to +400°C.

## Base materials

high-strength, unalloyed and alloyed structural and quenched and tempered steels among themselves or among each other, unalloyed and alloyed boiler or structural steels with highalloy Cr, CrNi and CrNiMo steels. Austenite-ferrite joints for boiler and pressure vessel construction. Particularly suitable for the first layer of corrosion-resistant Mo-alloyed weld claddings on P235G1TH, P255G1TH, S255N, P295GH, S355N - S500N and on creep resistant, quenched and tempered fine-grained structural steels according to AD HP 0, test group 3.

## Typical analysis of all-weld metal (Wt-%)

C	Si	Mn	Cr	Ni	Mo
0,02	0,7	0,8	23,0	12,5	2,7

## Mechanical properties of all-weld metal

Heat Treatment	Yield strength 0,2%	Tensile strength	Elongation ( $L_0=5d_0$ )	Impact values in J CVN	
				+20°C:	-20°C:
untreated	580	720	27	55	45

## Operating data



Polarity = + / -

## Dimensions (mm) Amperage A

2,0 x 300	45-60
2,5 x 250/350	60-80
3,2 x 350	80-120
4,0 x 350/450	100-160
5,0 x 450	140-220

## Approvals and certificates

TÜV-D (1362.), ABS (E 309 Mo), LR (DXV and O, CMnSS), DNV (309 MoL), BV (309 Mo), RINA (309MO), LTSS, SEPROZ, NAKS, CE

## Similar alloy filler metals

Stick electrode:	FOX CN 23/12-A	Metal powder wire:	CN 23/12-MC
TIG rod:	CN 23/12-IG	Flu cored wire:	CN 23/12-FD
Solid wire electrode:	CN 23/12-IG		CN 23/12 PW-FD
Wire/flux combination:	CN 23/12-UP/BB 202		CN 23/12 Mo-FD
			CN 23/12 Mo PW-FD



## Classifications

high-alloyed

EN ISO 3581-A:

AWS A5.4:

E 25 20 B 2 2

E310-15 (mod.)

## Characteristics and field of use

Core wire alloyed, basic coated stick electrode for same-type, heat-resistant rolled, forged and cast steels such as in annealing shops, hardening shops, steam boiler construction, the petrochemical industry and the ceramic industry. Joint welds on heat-resistant Cr-Si-Al steels that are exposed to gases containing sulphur must be carried out using BÖHLER FOX FA as a final layer. Due to the risk of embrittlement, the temperature range between 650-900°C should be avoided. Resistant to scaling up to +1200 C. Cryogenic down to -196 C.

## Base materials

austenitic 1.4841 X15CrNiSi25-21, 1.4845 X8CrNi25-21, 1.4828 X15CrNiSi20-12, 1.4840 GX15Cr-Ni25-20, 1.4846 X40CrNi25-21, 1.4826 GX40CrNiSi22-10 ferritic-pearlitic 1.4713 X10CrAlSi7, 1.4724 X10CrAlSi13, 1.4742 X10CrAlSi18, 1.4762 X10CrAlSi25, 1.4710 GX30CrSi7, 1.4740 GX40CrSi17 AISI 305, 310, 314, ASTM A297 HF, A297 HJ

## Typical analysis of all-weld metal (Wt-%)

C	Si	Mn	Cr	Ni
0,12	0,6	3,2	25,0	20,5

## Mechanical properties of all-weld metal

Heat Treatment	Yield strength 0,2%	Tensile strength	Elongation (L <sub>0</sub> =5d <sub>0</sub> )	Impact values in J CVN	
	MPa	MPa	%	+20°C:	-196°C:
untreated	420	600	36	100	≥ 32

## Operating data



Polarity = +

## Dimensions (mm)

## Amperage A

2,5 x 300	50-75
3,2 x 350	80-110
4,0 x 350	110-140
5,0 x 450	140-180

## Approvals and certificates

TÜV-D (0143.), Statoil, SEPROZ, CE

## Similar alloy filler metals

Stick electrode:	FOX FFB-A	Solid wire electrode:	FFB-IG
TIG rod:	FFB-IG		

## Classifications

high-alloyed

EN ISO 3581-A:

AWS A5.4:

E 25 20 R 3 2

E310-16

## Characteristics and field of use

Core wire alloyed, rutile coated stick electrode for same-type, heat-resistant rolled steels such as in annealing shops, hardening shops, steam boiler construction, the petrochemical industry and the ceramic industry. The final layer of joints that are exposed to reducing gases containing sulphur must be welded with BÖHLER FOX FA. The BÖHLER FOX FFB basic stick electrode is preferable for thick-walled welded constructions. Smooth seams and easy slag removal. Resistant to scaling up to +1200°C. Due to the risk of embrittlement, the temperature range between +650-900°C should be avoided.

## Base materials

austenitic 1.4841 X15CrNiSi25-21, 1.4845 X8CrNi25-21, 1.4828 X15CrNiSi20-12, 1.4840 GX15CrNi25-20, 1.4846 X40CrNi25-21, 1.4826 GX40CrNiSi22-10 ferritic-pearlitic 1.4713 X10CrAlSi7, 1.4724 X10CrAlSi13, 1.4742 X10CrAlSi18, 1.4762 X10CrAlSi25, 1.4710 GX30CrSi7, 1.4740 GX40CrSi17 AISI 305, 310, 314, ASTM A297 HF, A297 HJ

## Typical analysis of all-weld metal (Wt-%)

C	Si	Mn	Cr	Ni
0,12	0,5	2,2	26,0	21,0

## Mechanical properties of all-weld metal

Heat Treatment	Yield strength	Tensile strength	Elongation	Impact values in J CVN
	0,2%		( $L_0=5d_0$ )	
	MPa	MPa	%	+20°C:
untreated	430	620	35	75

## Operating data



Polarity = + / ~

## Dimensions (mm)

## Amperage A

2,0 x 300	40-60
2,5 x 300	50-80
3,2 x 350	80-110
4,0 x 350	110-140

## Approvals and certificates

Statoil, SEPROZ, CE

## Similar alloy filler metals

Stick electrode:	FOX FFB	Solid wire electrode:	FFB-IG
TIG rod:	FFB-IG		

<b>Classifications</b>	<b>high-alloyed</b>
------------------------	---------------------

EN ISO 3581-A:	AWS A5.4:	
E 25 20 R	E310-17	

#### Characteristics and field of use

Avesta 310 is a 25 Cr 20 Ni electrode for welding 1.4845/ASTM 310S and similar types of high temperature stainless steels. To minimise the risk of hot cracking when welding fully austenitic steels and nickel base alloys, heat input and interpass temperature must be low and there must be as little dilution as possible from the parent metal.

#### Base materials

For welding steels such as					
Outokumpu	EN	ASTM	BS	NF	SS
4845	1.4845	310S	310S16	Z8 CN 25-20	2361

#### Typical analysis of all-weld metal (Wt-%)

C	Si	Mn	Cr	Ni
0,10	0,5	2,1	26,0	21,0

#### Mechanical properties of all-weld metal

Heat Treatment	Yield strength 0,2%	Tensile strength	Elongation ( $L_0=5d_0$ )	Impact values in J CVN	
	MPa	MPa	%	+20°C:	-196°C:
untreated	440	625	35	80	50

#### Operating data



Polarity = + / -

Dimensions (mm)	Amperage A
2,5	50-75
3,25	70-100
4,0	100-150

# Avesta 2507/P100 rutile

Stick electrode

## Classifications

high-alloyed

EN ISO 3581-A:

AWS A5.4:

E 25 9 4 N L R

E2594-16

## Characteristics and field of use

Avesta 2507/P100 rutile is designed for welding super duplex steels such as 2507/1.4410. The weldability of duplex and super duplex steels is excellent, but the welding should be adapted to the base material, considering fluidity, joint design, heat input etc.

## Base materials

For welding steels such as					
Outokumpu	EN	ASTM	BS	NF	SS
2507	1.4410	S32750	-	Z3 CND 25-06 Az	2328

## Typical analysis of all-weld metal (Wt-%)

C	Si	Mn	Cr	Ni	Mo	N
0,03	0,5	1,3	25,2	9,5	3,6	0,23

## Mechanical properties of all-weld metal

Heat Treatment	Yield strength 0,2%	Tensile strength	Elongation ( $L_0=5d_0$ )	Impact values in J CVN	
	MPa	MPa	%	+20°C:	-46°C:
untreated	700	900	26	80	45

## Operating data



Polarity = + / -

Dimensions (mm)	Amperage A
2,5	50-70
3,25	80-100
4,0	100-140

**Classifications** high-alloyed

EN ISO 3581-A:	AWS A5.4:	
E 25 9 4 N L B 2 2	E2553-15 (mod.)	

**Characteristics and field of use**

Stainless. Resistance to intercrystalline corrosion – wet corrosion up to 250 °C (482 °F). Very good resistance to pitting corrosion and stress corrosion cracking due to the high CrMo(N) content (pitting index >40). Well suited for offshore applications.

**Base materials**

1.4515 – GX3CrNiMoCuN26-6-3 1.4517 – GX3CrNiMoCuN26-6-3-3 25 % Cr-superduplex steels such as SAF 25/07, Zeron 100

**Typical analysis of all-weld metal (Wt-%)**

C	Si	Mn	Cr	Mo	Ni	N	Cu	W
0,03	0,5	1,2	25,0	3,7	9,0	0,2	0,7	0,6

**Mechanical properties of all-weld metal**

Heat Treatment	Yield strength 0,2%	Tensile strength	Elongation (L <sub>0</sub> =5d <sub>0</sub> )	Impact values in J CVN	
	MPa	MPa	%	+20°C:	-50°C:
untreated	600	750	25	70	50

**Operating data**



Polarity = +

Dimensions (mm)	Amperage A
2,5 x 350	55-80
3,2 x 350	80-105
4,0 x 350	90-140

**Classifications** high-alloyed

EN ISO 3581-A:		
E Z25 22 2 L B 2 2		

**Characteristics and field of use**

Stainless; resistant to intercrystalline corrosion – wet corrosion up to 350 °C (662 °F). Good resistance to Cl-bearing environments, pitting corrosion and nitric acid. Huey test to ASTM A262-64: 1.5 µ/48 h max., (0.25 g/m<sup>2</sup>h), selective attack 100 µ max. Particularly suited to corrosion conditions in urea synthesis plants. For joining and surfacing applications with matching/similar steels. For weld cladding on high temperature steels and for fabricating joints on claddings.

**Base materials**

1.4465 – X2CrNiMoN25-25 1.4466 – X2CrNiMoN25-22-2 1.4435 – X2CrNiMo18-14-3

**Typical analysis of all-weld metal (Wt-%)**

C	Si	Mn	Cr	Mo	Ni	N
0.035	0,4	5,0	24,5	2,2	22,0	0,15

**Mechanical properties of all-weld metal**

Heat Treatment	Yield strength 0,2%	Tensile strength	Elongation (L <sub>0</sub> =5d <sub>0</sub> )	Impact values in J CVN
	MPa	MPa	%	at RT
untreated	400	600	30	80

**Operating data**



Polarity = +

**Dimensions (mm)      Amperage A**

2,5 x 300	55-80
3,2 x 350	80-105
4,0 x 350	90-135

**Approvals and certificates**

TÜV (Certificate No. 04171)

## Classifications

high-alloyed

EN ISO 3581-A:

E 29 9 R

## Characteristics and field of use

Avesta P7 is a high-alloyed Cr-Ni electrode with approx. 40% ferrite offering high tensile strength and excellent resistance to cracking. The chemical composition corresponds to AWS A5.4 E312. Avesta P7 is primarily intended for welding dissimilar joints between stainless steel, high strength steels such as Armox® and Hardox®, tool steel, spring steel and 14% Mn-steel, as well as other difficult-to-weld combinations.

## Base materials

For welding steels such as					
Outokumpu	EN	ASTM	BS	NF	SS
Specially designed for difficult-to-weld steels such as Mn-steels, tool steels and high temperature grades.					

## Typical analysis of all-weld metal (Wt-%)

C	Si	Mn	Cr	Ni
0,09	0,8	0,8	29,0	9,5

## Mechanical properties of all-weld metal

Heat Treatment	Yield strength 0,2%	Tensile strength	Elongation ( $L_0=5d_0$ )	Impact values in J CVN
	MPa	MPa	%	+20°C:
untreated	620	810	20	25

## Operating data

	Polarity = + / -
--	------------------

Dimensions (mm)	Amperage A
2,5	50-80
3,25	80-120
4,0	100-160
5,0	160-220

## Classifications

high-alloyed

EN ISO 3581-A:

E 29 9 R 12

## Characteristics and field of use

UTP 65 D has been developed to satisfy the highest requirements for joining and surfacing. It is extremely crack-resistant when joining steels of difficult weldability, such as e. g. hard manganese steels, tool steels, spring steels, high speed steels as well as dissimilar metal joints. Due to the good corrosion and abrasion resistance and high tensile strength UTP 65 D finds its application particularly in repair and maintenance of machine and drive components, such as gears, cams, shafts, hot cuts, hot trim plates and dies. Also ideally suited as an elastic cushioning layer for very hard surfacings.

### Welding characteristics and special properties of the weld metal

UTP 65 D has outstanding welding properties. Stable arc, spatterfree. The finely rippled seam has a homogeneous structure, very good slag removal, self-lifting on parts. Good weldability in awkward positions. Stainless, creep resistant and workhardening.

### Welding instructions

Clean the welding zone thoroughly. Prepare X-, V- or U-groove on thickwalled workpieces with an angle of 60 - 80°. Preheat high-C-containing steels and solid workpieces to appr. 250° C. Keep stick electrode vertical and weld with a short arc, use stringer beads or slight weaving, as applicable. Re-dry stick electrodes that have got damp for 2 h / 120 – 200° C.

## Base materials

hard manganese steels, tool steels, spring steels, high speed steels as well as dissimilar metal joints

## Typical analysis of all-weld metal (Wt-%)

C	Si	Mn	Cr	Ni	Fe
0,1	1,0	1,0	30,0	9,5	balance

## Mechanical properties of all-weld metal

Heat Treatment	Yield strength 0,2%	Tensile strength	Elongation ( $L_0=5d_0$ )	Impact values in J CVN
	MPa	MPa	%	
untreated	640	800	20	

## Operating data



Polarity = + / ~

## Dimensions (mm)

## Amperage A

1,5 x 250	35-45
2,0 x 250	45-60
2,5 x 250	55-75
3,2 x 350	75-115
4,0 x 350	100-145
5,0 x 350	120-190



## Classifications

high-alloyed

EN 1600:

AWS A5.4:

E 29 9 R 1 2

E312-16 (mod.)

## Characteristics and field of use

Stainless; wet corrosion up to 300 °C (572 °F). High resistance to hot cracking: good toughness at high yield strength. For joining and surfacing applications with matching/similar steels/cast steel grades. For fabricating tough joints on unalloyed/low alloy structural steels of higher strength, on high manganese and CrNiMn steels, between dissimilar metals e.g. between stainless or heat resistant and unalloyed/low alloy steels/cast steel grades.

## Base materials

DB-approved parent metals 1.4006 – X10Cr13, 1.3401 – X120Mn12, S235 St 37 , E295 St 50 ; Useable for joint welding on limited weldable unalloyed and low alloyed steels of higher strength. Used as stress relieved buffer layer when cladding cold and warm machine tools. For joinings on high manganese steel and CrNiMn steel, as well as for combinations on steels of different chemical composition or strength.

## Typical analysis of all-weld metal (Wt-%)

C	Si	Mn	Cr	Mo	Ni
0,10	1,1	0,8	29,0	9,0	0,1

## Mechanical properties of all-weld metal

Heat Treatment	Yield strength 1,0%	Tensile strength	Elongation (L <sub>0</sub> =5d <sub>0</sub> )	Impact values in J CVN
	MPa	MPa	%	at RT
untreated	500	750	20	25

## Operating data



Polarity = + / -

## Dimensions (mm)

## Amperage A

2,0 x 250	45-60
2,5 x 300	50-80
3,2 x 350	60-110
4,0 x 350	90-150
5,0 x 450	150-210

## Approvals and certificates

Approvals DB (Reg. form No. 30.132.11)

## Classifications

high-alloyed

EN ISO 3581-A:

AWS A5.4:

E 29 9 R 3 2

E312-17

## Characteristics and field of use

Core wire alloyed, austenitic-ferritic special stick electrodes with rutile coating. Suitable for hard-to-weld materials of high-strength such as pressing and trimming tools, due to the high ferrite content and high crack resistance. Joints between dissimilar steels, tough intermediate layers in case of hardfacing. Suitable for wear-resistant surfacing on couplings, toothed wheels, shafts and the like due to the high mechanical strength and strain-hardening capacity. Can also be used for tool repairs. BÖHLER FOX CN 29/9-A has exceptional position welding properties, and is particularly suitable for welding with AC power.

## Base materials

Use for joint welding of unalloyed and low-alloy steels of high-strength and limited weldability. Use as buffer layer for surfacings on cold and hot working tools. Also suitable for joints on austenitic Mn steel and Cr-Ni-Mn steel, as well as for dissimilar joints on steels of different chemical composition or strength.

## Typical analysis of all-weld metal (Wt-%)

C	Si	Mn	Cr	Ni
0,11	0,9	0,7	28,8	9,5

## Mechanical properties of all-weld metal

Heat Treatment	Yield strength 0,2%	Tensile strength	Elongation ( $L_0=5d_0$ )	Impact values in J CVN
	MPa	MPa	%	+20°C:
untreated	650	790	24	30

## Operating data



Polarity = + / ~

## Dimensions (mm)

## Amperage A

2,0 x 350	60-80
3,2 x 350	80-110
4,0 x 350	110-140
5,0 x 450	140-180

## Approvals and certificates

DB (30.014.16, 20.014.07), CE

## Classifications

high-alloyed

EN ISO 3581-A:

E 29 9 R 32

## Characteristics and field of use

UTP 65 is particularly suitable for joinings on hardly weldable steels, when highest demands on the welding seam are made. High crack resistance when joining parent metals of difficult weldability, such as austenitic and ferritic steels, high-manganese steels with alloyed and non-alloyed steels, heat-treatable and tool steels. As cushion layer on these materials it is also ideally suited. UTP 65 finds a variety of applications in the repair and maintenance of machine and drive components as well as in tool repairing.

**Welding characteristics and special properties of the weld metal**

UTP 65 is very easily weldable with a smooth and stable arc, homogeneous, finely rippled bead appearance and gives very good slag removal, self-lifting in parts. The austenitic-ferritic weld deposit has highest strength values and high crack resistance. Workhardening, creep resistant and stainless.

**Welding instructions**

Clean welding area thoroughly. Pre-heating of thick-walled ferritic parts to 150 – 250° C. Keep the arc short up to medium-long. Apply string beads with little weaving. Hold stick electrode as vertically as possible. Redry stick electrodes that have got damp for 2 h / 120 – 200 °C.

## Base materials

Dissimilar joints.

## Typical analysis of all-weld metal (Wt-%)

C	Si	Mn	Cr	Ni	Fe
0,1	1,0	1,0	29,0	9,0	balance

## Mechanical properties of all-weld metal

Heat Treatment	Yield strength 0,2%	Tensile strength	Elongation ( $L_0=5d_0$ )	Impact values in J CVN
	MPa	MPa	%	
untreated	620	800	22	

## Operating data



Polarity = + / -

## Dimensions (mm)

## Amperage A

1,5 x 250	35-50
2,0 x 250	45-65
2,5 x 250	60-80
3,2 x 350	80-130
4,0 x 350	110-150
5,0 x 350	120-200

## Approvals and certificates

DB (No. 82.138.01)

## Classifications

high-alloyed

AWS A5.4:

E317L-17

## Characteristics and field of use

Avesta 317L/SNR AC/DC is a high Mo-alloyed electrode corresponding to AWS A5.4 E 317L designed for welding 1.4438/ASTM 317L steel.

## Base materials

For welding steels such as					
Outokumpu	EN	ASTM	BS	NF	SS
4438	1.4438	317L	317S12	Z3 CND 19-15-04	2367

## Typical analysis of all-weld metal (Wt-%)

C	Si	Mn	Cr	Ni	Mo
0,02	0,7	0,9	19,2	13,0	3,7

## Mechanical properties of all-weld metal

Heat Treatment	Yield strength 0,2%	Tensile strength	Elongation ( $L_0=5d_0$ )	Impact values in J CVN
	MPa	MPa	%	+20°C:
untreated	485	615	32	55

## Operating data



Polarity = + / -

Dimensions (mm)	Amperage A
2,0	35-60
2,5	50-80
3,25	80-120
4,0	100-160
5,0	160-220

**Classifications**

high-alloyed

EN ISO 3581-A:

EZ 25 35 Nb B 6 2

**Characteristics and field of use**

UTP 2535 Nb is suitable for joining and surfacing of heat resistant CrNi-cast steels (centrifugal- and mould cast parts) of the same or of similar nature.

**Welding characteristics and special properties of the weld metal**

It is used for operating temperatures up to 1100° C in carburized low-sulphur combustion gas, e. g. reforming ovens in petrochemical plants.

**Welding instructions**

Hold stick electrode vertically with a short arc and lowest heat input. String beads are welded. The interpass temperature of 150° C should not be exceeded. Re-dry stick electrodes for 2 - 3 hours at 250 - 300 C

**Base materials**

1.4852 G - X 40 NiCrSiNb 35 26

1.4857 G - X 40 NiCrSi 35 26

**Typical analysis of all-weld metal (Wt-%)**

C	Si	Mn	Cr	Ni	Nb	Ti	Fe
0,4	1,0	1,5	25,0	35,0	1,2	0,1	balance

**Mechanical properties of all-weld metal**

Heat Treatment	Yield strength 0,2%	Tensile strength	Elongation (L <sub>0</sub> =5d <sub>0</sub> )	Impact values in J CVN
	MPa	MPa	%	
untreated	480	700	8	

**Operating data**



Polarity: = +

Dimensions (mm)	Amperage A
2,5 x 300	50-70
3,2 x 350	70-120
4,0 x 400	100-140
5,0 x 400	

**Classifications**

nickel-based

EN ISO 14172:	AWS A5.11:
E Ni 6625 (NiCr22Mo9Nb)	ENiCrMo-3

**Characteristics and field of use**

Core wire alloyed special stick electrode with special basic coating for high quality welded joints of nickel-based alloys with a high Mo content (e.g. Alloy 625 and Alloy 825) and of CrNiMo steels with a high Mo content (e.g. 6% Mo steels). This type is also suitable for creep resistant and highly creep resistant steels, heat resistant and cryogenic materials, dissimilar joints and low-alloy, hard-to-weld steels. Suitable for pressure vessel construction for -196°C to +550°C, otherwise with scaling resistance up to +1200°C (sulphur-free atmosphere). Because of the embrittlement of the base material between 600 and 850°C, use in this temperature range should be avoided. High resistance to hot cracking, in addition to which the C-diffusion at high temperatures or during heat treatment of dissimilar joints is largely inhibited. Extremely high resistance to stress corrosion cracking and pitting (PREN 52). Resistant to thermal shock, stainless, fully austenitic. Low expansion coefficient between C-steel and austenitic CrNi(Mo) steel. Exceptional welding properties in all positions except for vertical down, good slag detachability, high resistance to porosity, notch-free weld seams, high degree of purity. The electrode and the weld metal meet the highest quality requirements.

**Base materials**

2.4856 NiCr 22 Mo 9 Nb, 2.4858 NiCr 21 Mo, 2.4816 NiCr 15 Fe, 1.4583 X10CrNiMoNb18-12, 1.4876 X 10 NiCrAlTi 32 20 H, 1.4876 X 10 NiCrAlTi 32 21, 1.4529 X1NiCrMoCuN25-20-7, X 2 CrNiMoCuN 20 18 6, 2.4641 NiCr 21 Mo 6 Cu Joints of the above-mentioned materials with unalloyed and low-alloy steels e.g. P265GH, P285NH, P295GH, 16Mo3, S355N, X8Ni9, ASTM A 553 Gr.1, N 08926, Alloy 600, Alloy 625, Alloy 800 (H), 9 % Ni steels

**Typical analysis of all-weld metal (Wt-%)**

C	Si	Mn	Cr	Ni	Mo	Al	Nb	Co	Fe
0,025	0,4	0,7	22,0	bal.	9,0	=0,4	3,3	=0,05	0,5

**Mechanical properties of all-weld metal**

Heat Treatment	Yield strength	Tensile strength	Elongation	Impact values	
	0,2%		( $L_0=5d_0$ )	in J CVN	
	MPa	MPa	%	+20°C:	-196°C:
untreated	530	800	40	80	45

**Operating data**

Polarity = +

Dimensions (mm)	Amperage A
2,5 x 250	45-60
3,2 x 300	65-95
4,0 x 350	90-120

**Approvals and certificates**

TÜV-D (04911.), Statoil, NAKS, LTSS, SEPROZ, CE (FOX NiCr 625: TÜV-D (03773.))

**Similar alloy filler metals**

TIG rod:	NIBAS 625-IG NiCr 625-IG A*	Wire/flux combination:	NIBAS 625-UP/BB 444 NiCr 625-IG A
Solid wire electrode:	NIBAS 625-IG	Flu cored wire:	NIBAS 625 PW-FD

\* Brand name German

### Classifications

nickel-based

EN ISO 14172:

AWS A5.11:

E Ni 6625 (NiCr22Mo9Nb)

ENiCrMo-3

### Characteristics and field of use

Stainless; high resistance to corrosive environments. Resistant to stress corrosion cracking. Resistant to scaling up to 1100 °C (2012 °F). Temperature limit: 500 °C (932 °F) max. in sulphureous atmospheres. High temperature resistant up to 1000 °C (1832 °F). Cold toughness at subzero temperatures as low as -196 °C (-321 °F). For joining and surfacing work with matching/similar corrosion resistant materials as well as on matching and similar heat resistant, high temperature steels and alloys. For joining and surfacing work with cryogenic austenitic CrNi(N) steels/cast steel grades and on cryogenic Ni steels suitable for quenching and tempering.

### Base materials

X10NiCrAlTi32-20 H, 1.4876 – X10NiCrAlTi32-20, 2.4856 – NiCr22Mo9Nb, 1.4539 – X2NiCrMo-Cu25-20-5, X2CrNiMoCuN20-18-6, VdTÜV-WBL. 473; Alloy 600, Alloy 625, Alloy 800, 9% Ni steels

### Typical analysis of all-weld metal (Wt-%)

C	Si	Mn	Cr	Mo	Ni	Nb	Fe
0,04	0,7	1	21,5	9,5	bal.	3,3	2,0

### Mechanical properties of all-weld metal

Heat Treatment	Yield strength 0,2%	Tensile strength	Elongation ( $L_0=5d_0$ )	Impact values in J CVN	
	MPa	MPa	%	+20 °C:	-196 °C:
untreated	420	760	30	75	60

### Operating data



Polarity = +

### Dimensions (mm)

### Amperage A

2,5 x 250	45-70
3,2 x 300	65-105
4,0 x 350	85-130
5,0 x 400	130-160

### Approvals and certificates

TÜV (Certificate No. 03463), ABS, DNV, GL

## Classifications

nickel-based

EN ISO 14172:

AWS A5.11:

E Ni 6625 (NiCr22Mo9Nb)

ENiCrMo-3

## Characteristics and field of use

UTP 6222 Mo is particularly suited for joining and surfacing on nickel alloys, austenitic steels, low temperature nickel steels, austenitic-ferritic-joints and claddings of the same or similar nature, like 2.4856 (NiCr22Mo 9 Nb), 1.4876 (X30 NiCrAlTi 32 20), 1.4529 (X2 NiCrMoCu 25 20 5).

### Welding characteristics and special properties of the weld metal

The weld metal is heat resistant and suitable for operating temperatures up to 1000° C. It must be noted that a slight decrease in ductility will occur if prolonged heat treatment is given within the temperature range 600 - 800 °C. Scale-resisting in low-sulphur atmosphere up to 1100 °C. High creep strength.

### Welding instructions

Opening angle of the prepared seam approx. 70°, root gap approx. 2 mm. Weld stick electrode with slight tilt and short arc. String beads are welded. The interpass temperature of 150° C and a max. weaving with 2,5 x diameter of the stick electrode core wire should not be exceeded. Re-dry the stick electrodes 2 - 3 hours at 250 - 300° C before use and weld them out of a warm electrode carrier.

## Base materials

X10NiCrAlTi32-20 H, 1.4876 - X10NiCrAlTi32-20, 2.4856 - NiCr-22Mo9Nb, 1.4539 - X2NiCrMo-Cu25-20-5, X2CrNiMoCuN20-18-6, VdTÜV-WBL. 473; Alloy 600, Alloy 625, Alloy 800, 9% Ni steels

## Typical analysis of all-weld metal (Wt-%)

C	Si	Mn	Cr	Mo	Ni	Nb	Fe
0,03	0,4	0,6	22,0	9,0	bal.	3,3	1,5

## Mechanical properties of all-weld metal

Heat Treatment	Yield strength 0,2%	Tensile strength	Elongation ( $L_0=5d_0$ )	Impact values in J CVN	
				+20 °C:	-196 °C:
untreated	450	760	30	75	45

## Operating data



Polarity: = +

## Dimensions (mm)

Dimensions (mm)	Amperage A
2,5 x 250	50-70
3,2 x 300	70-95
4,0 x 350	90-120
5,0 x 400	120-160

## Approvals and certificates

TÜV (No. 03610), DNV, ABS, GL, BV



**Classifications**

nickel-based

EN ISO 14172:

AWS A5.11:

E Ni 6082 (NiCr20Mn3Nb)

ENiCrFe-3 (mod.)

**Characteristics and field of use**

Core wire alloyed special stick electrode corresponding to AWS ENiCrFe-3 with special basic coating, for high-quality welding of nickel-based alloys, creep resistant and highly creep resistant steels, heat-resistant and cryogenic materials, and also for low-alloy hard-to-weld steels and dissimilar joints. Also for ferrite-austenite joints at operating temperatures  $\geq 300^{\circ}\text{C}$  or heat treatments. Suitable for pressure vessel construction for  $-196^{\circ}\text{C}$  to  $+650^{\circ}\text{C}$ , otherwise with scaling resistance up to  $+1200^{\circ}\text{C}$  (sulphur-free atmosphere). Does not tend to embrittlement, high resistance to hot cracking, in addition to which the C-diffusion at high temperatures or during heat treatment of dissimilar joints is largely inhibited. Resistant to thermal shock, stainless, fully austenitic. Low expansion coefficient between C-steel and austenitic Cr-Ni-(Mo) steel. Exceptional welding properties in all positions except for vertical down, good slag detachability, high resistance to porosity, notch-free weld seams, high degree of purity. The electrode and the weld metal meet the highest quality requirements.

**Base materials**

2.4816 NiCr15Fe, 2.4817 LC-NiCr15Fe Nickel and nickel alloys, low-temperature steels up to X8Ni9, high-alloyed Cr and CrNiMo steels, particularly for dissimilar joints, and their joints to unalloyed, low-alloy, creep resistant and highly creep resistant steels. Also suitable for Alloy 800.

**Typical analysis of all-weld metal (Wt-%)**

C	Si	Mn	Cr	Ni	Mo	Ti	Nb	Co	Fe
0,025	0,4	5,0	19,0	bal.	1,5	+	2,2	=0,08	3,0

**Mechanical properties of all-weld metal**

Heat Treatment	Yield strength 0,2%	Tensile strength	Elongation ( $L_0=5d_0$ )	Impact values in J CVN	
				+20°C:	-196°C:
untreated	420	680	40	120	80

**Operating data**

Polarity = +

**Dimensions (mm)**
**Amperage A**

2,5 x 300	40-70
3,2 x 300	70-105
4,0 x 350	90-125
5,0 x 400	120-160

**Approvals and certificates**

TÜV-D (04697.), Statoil, LTSS, SEPROZ, CE, NAKS (FOX NiCr 70 Nb: TÜV-D (00889.), KTA 1408.1 (08039.))

**Similar alloy filler metals**

TIG rod:	NIBAS 70/20-IG NiCr 70 Nb-IG A*	Solid wire electrode:	NIBAS 70/20-IG NiCr 70 Nb-IG A*
Flu cored wire:	NIBAS 70/20-FD	Wire/flux combination:	NIBAS 70/20-UP/BB 444

# Thermanit Nicro 82

Stick electrode

## Classifications

nickel-based

EN ISO 14172:

AWS A5.11:

E Ni 6082 (NiCr20Mn3Nb)

ENiCrFe-3 (mod.)

## Characteristics and field of use

Stainless; heat resistant; high temperature resistant. Cold toughness at subzero temperatures as low as  $-269\text{ }^{\circ}\text{C}$  ( $-452\text{ }^{\circ}\text{F}$ ). Well suited for welding austenitic ferritic joints. No Cr carbide zones that become brittle in the ferrite weld deposit transition zone, even not as a result of heat treatments above  $300\text{ }^{\circ}\text{C}$  ( $572\text{ }^{\circ}\text{F}$ ). Well suited for tough joints and surfacing on heat resistant Cr and CrNi steels/cast steel grades and Ni-base alloys. Temperature limits:  $500\text{ }^{\circ}\text{C}$  ( $932\text{ }^{\circ}\text{F}$ ) in sulphureous atmospheres,  $800\text{ }^{\circ}\text{C}$  max ( $1472\text{ }^{\circ}\text{F}$ ) for fully stressed welds. Resistant to scaling up to  $1000\text{ }^{\circ}\text{C}$  ( $1832\text{ }^{\circ}\text{F}$ ).

## Base materials

1.4876 – X10NiCrAlTi32-30H; 2.4816 – NiCr15Fe; X8Ni9; 10CrMo9-10;  
Combinations between 1.4583 – X10CrNiMoNb18-12, 1.4539 – X2NiCrMoCu25-20 and ferritic boiler steels; Alloy 600, Alloy 600L, Alloy 800 (H)

## Typical analysis of all-weld metal (Wt-%)

C	Si	Mn	Cr	Ni	Nb	Fe
0,05	0,4	4,0	19,5	bal.	2,0	4,0

## Mechanical properties of all-weld metal

Heat Treatment	Yield strength 0,2%	Tensile strength	Elongation ( $L_0=5d_0$ )	Impact values in J CVN		
	MPa	MPa	%	+20 °C:	-196 °C:	-269 °C:
untreated	380	620	35	90	70	50

## Operating data



Polarity = +

## Dimensions (mm)

## Amperage A

2,5 x 300	45-70
3,2 x 300	65-100
4,0 x 350	85-130
5,0 x 400	130-160

## Approvals and certificates

TÜV (Certificate No. 01775), TÜV (KTA), GL

## Classifications

nickel-based

EN ISO 14172:

AWS A5.11:

E Ni 6082 (NiCr20Mn3Nb)

E NiCrFe-3 (mod.)

## Characteristics and field of use

UTP 068 HH is predominantly used for joining identical or similar heat resistant Ni-base alloys, heat resistant austenites, cold tough Ni-steel, and for joining heat resistant austenitic-ferritic materials, such as 2.4817 (LC NiCr15Fe), 2.4851 (NiCr23Fe), 1.4876 (X10 NiCrTiAl 32 20), 1.4941 (X8 CrNTi 18 10). Specially also used for joinings of high C content 25/35 CrNi cast steel to 1.4859 or 1.4876 for petrochemical installations with working temperatures up to 900° C. The welding deposit is hot cracking resistant and does not tend to embrittlement.

## Base materials

1.4876 – X10NiCrAlTi32-30H; 2.4816 – NiCr15Fe; X8Ni9; 10CrMo9-10;  
Combinations between 1.4583 – X10CrNiMoNb18-12, 1.4539 – X2NiCrMoCu25-20 and ferritic boiler steels; Alloy 600, Alloy 600L, Alloy 800 (H)

## Typical analysis of all-weld metal (Wt-%)

C	Si	Mn	Cr	Mo	Nb	Fe	Ni
0,03	0,4	5	19,0	1,5	2,2	3	bal.

## Mechanical properties of all-weld metal

Heat Treatment	Yield strength 0,2%	Tensile strength	Elongation ( $L_0=5d_0$ )	Impact values in J CVN	
				+20 °C:	-196 °C:
untreated	420	680	40	120	80

## Operating data



Polarity = +

Dimensions (mm)

Amperage A

2,5 x 300

50-70

3,2 x 300

70-95

4,0 x 350

90-120

5,0 x 400

120-160

## Approvals and certificates

TÜV, ABS, GL, BV, DNV, C

# UTP 6170 Co

Stick electrode

## Classifications

nickel-based

EN ISO 14172:

AWS A5.11:

E Ni 6117 (NiCr22Co12Mo)

ENiCrCoMo-1 (mod.)

## Characteristics and field of use

UTP 6170 Co mod. is suitable for joining high-temperature and similar nickel-base alloys, heat resistant austenitic and cast alloys, such as 2.4663 (NiCr23Co12Mo), 2.4851 (NiCr23Fe), 1.4876 (X10 NiCrAlTi 32 21), 1.4859 (GX10 NiCrSiNb 32 20). The weld metal is resistant to hot-cracking and is used for service temperatures up to 1100° C. Scale-resistance up to 1100° C in oxidizing and carburized atmospheres, e. g. gas turbines, ethylene production plants.

### Welding characteristics and special properties of the weld metal

UTP 6170 Co mod can be welded in all positions except vertical-down. It has a stable arc. The seam is finely rippled and notch-free. Easy slag removal.

### Welding instructions

Hold stick electrode as vertically as possible, keep a short arc. Use string bead technique. Fill end crater carefully. Interpass temperature max. 150° C. Re-dry stick electrodes for 2–3 h / 250–300° C.

## Base materials

X10NiCrAlTi32-20 (1.4876) NiCr23Fe (2.4851) GX10NiCrNb32-20 (1.4859) NiCr23Co12Mo (2.4663) UNS N06617, Alloy 617

## Typical analysis of all-weld metal (Wt-%)

C	Si	Mn	Cr	Mo	Ni	Co	Al	Ti	Fe
0,06	0,8	0,3	21,0	9,0	bal.	11,0	0,7	0,3	1,0

## Mechanical properties of all-weld metal

Heat Treatment	Yield strength 0,2%	Tensile strength	Elongation ( $L_0=5d_0$ )	Impact values in J CVN
	MPa	MPa	%	at RT
untreated	450	700	35	100

## Operating data



Polarity = +

Dimensions (mm)

Amperage A

2,5 x 300

55-75

3,2 x 300

70-100

4,0 x 350

90-120

## Approvals and certificates

TÜV (No. 04661)

## Classifications

nickel-based

EN ISO 14172:

AWS A5.11:

E Ni 6182 (NiCr15Fe6Mn)

ENiCrFe-3

## Characteristics and field of use

Stainless; resistant to scaling up to 950 °C (1742 °F), high temperature resistant up to 800 °C (1472 °F). Cold toughness at subzero temperatures as low as -196 °C (-321 °F). Well suited for austenitic ferritic joints. No Cr carbide zones that become brittle in the ferrite weld deposit transition zone even not as a result of heat treatments above 300 °C (572 °F). Well suited for tough joints and surfacing on heat resistant Cr- and CrNi steels/cast steel grades and Ni-base alloys. Temperature limits: 500 °C (932 °F) in sulphurous atmospheres, 800 °C (1472 °F) max. for fully stressed welds.

For welding work on cryogenic steels/cast steel grades including Ni steels suitable for quenching and tempering. For joining applications on steels with a low expansion coefficient (Dilavar, Invar).

## Base materials

1.4876 – X10NiCrAlTi32-20; 2.4816 – NiCr15Fe; Cryogenic 1.5 - 5 % Ni steels; X8Ni9. Combinations of 1.4583 – X10CrNiMoNb18-12 and ferritic boiler steels up to 16Mo3; Alloy 800 (H)

## Typical analysis of all-weld metal (Wt-%)

C	Si	Mn	Cr	Ni	Nb	Fe
0,05	0,5	6,5	16	bal.	2,0	6,0

## Mechanical properties of all-weld metal

Heat Treatment	Yield strength 0,2%	Tensile strength	Elongation ( $L_0=5d_0$ )	Impact values in J CVN	
	MPa	MPa	%	+20 °C:	-196 °C:
untreated	350	620	35	90	70

## Operating data



Polarity = +

## Dimensions (mm)

## Amperage A

2,5 x 300	45-70
3,2 x 300	65-100
4,0 x 350	95-130
5,0 x 400	130-160

## Approvals and certificates

TÜV (Certificate No. 02073), TÜV (KTA), (Certificate No. 8109)

## Classifications

nickel-based

EN ISO 14172:	AWS A5.11:	
E Ni 6059 (NiCr23Mo16)	E NiCrMo-13	

## Characteristics and field of use

UTP 759 Kb is employed primarily for welding components in environmental plants and plants for chemical processes with highly corrosive media. Joint welding of matching base materials as Material-No. 2.4605 or similar matching materials as material No 2.4602 NiCr21Mo14W. Joint welding of these materials with low-alloyed steels. Cladding on low-alloyed steels.

### Welding characteristics and special properties of the weld metal

In addition to its good resistance to contaminated oxidating mineral acids, acetic acids and acetic anhydrides, hot contaminated sulphuric - and phosphoric acid, UTP 759 Kb has an excellent resistance against pitting and crevice corrosion. The special composition of the coating extensively prevents the precipitation of intermetallic phases.

UTP 759 Kb can be welded in all positions except vertical down. Stable arc, easy slag removal.

### Welding instructions

Opening angle of the prepared seam approx. 70°, root gap approx. 2 mm. Weld stick electrode with slight tilt and with a short arc. String beads are welded. The interpass temperature of 150° C and a max. weaving width 2,5 x diameter of the stick electrode core wire should not be exceeded. Re-dry the stick electrodes 2 – 3 hours at 250 – 300° C before use and weld them out of a warm stick electrode carrier.

## Base materials

2.4602 – NiCr21Mo14W – Alloy C-22; 2.4605 – NiCr23Mo16Al – Alloy 59; 2.4610 – NiMo16Cr16Ti – Alloy C-4; 2.4819 – NiMo16Cr15W – Alloy C-276

## Typical analysis of all-weld metal (Wt-%)

C	Si	Mn	Cr	Mo	Ni	Fe
0,02	0,2	0,5	22,5	15,5	bal.	1,0

## Mechanical properties of all-weld metal

Heat Treatment	Yield strength 0,2%	Tensile strength	Elongation ( $L_0=5d_0$ )	Impact values in J CVN
	MPa	MPa	%	at RT
untreated	450	720	30	75

## Operating data



Polarity = +

Dimensions (mm)	Amperage A
2,5 x 250	50-70
3,2 x 300	70-100
4,0 x 350	90-130

## Approvals and certificates

TÜV (No. 06687)

## Classifications nickel-based

EN ISO 14172:	AWS A5.11:	
E Ni 6059 (NiCr23Mo16)	ENiCrMo-13	

### Characteristics and field of use

Stainless. High corrosion resistance in reducing and, above all, in oxidizing environments. For joining and surfacing with matching and similar alloys and cast alloys. For welding the clad side of plates of matching and similar alloys.

### Base materials

2.4602 – NiCr21Mo14W – Alloy C-22; 2.4605 – NiCr23Mo16Al – Alloy 59; 2.4610 – NiMo16Cr16Ti – Alloy C-4; 2.4819 – NiMo16Cr15W – Alloy C-276

### Typical analysis of all-weld metal (Wt-%)

C	Si	Mn	Cr	Mo	Ni	Fe
0,02	0,10	0,5	23,0	16,0	bal.	1,5

### Mechanical properties of all-weld metal

Heat Treatment	Yield strength 0,2%	Tensile strength	Elongation ( $L_0=5d_0$ )	Impact values in J CVN
	MPa	MPa	%	at RT
untreated	420	700	40	60

### Operating data



Polarity = +

Dimensions (mm)	Amperage A
2,5 x 250	45-70
3,2 x 300	65-105
4,0 x 350	85-135

### Approvals and certificates

TÜV (Certificate No. 09272)

## Classifications

nickel-based

EN ISO 14172:

AWS A5.11:

E Ni 6182 (NiCr15Fe6Mn)

E NiCrFe-3

## Characteristics and field of use

UTP 7015 is employed for joining and surfacing of nickel-base materials. UTP 7015 is also recommended for welding different materials, such as austenitic to ferritic steels, as well as for weld claddings on unalloyed and low-alloyed steels, e. g. for reactor construction.

### Welding characteristics and special properties of the weld metal

I Weldable in all positions, except vertical down. Stable arc, good slag removability. The seam is finely rippled and notch-free. The weld deposit has a fully austenitic structure and is high-temperature resistant. Not prone to embrittlement either at high or low temperatures.

### Welding instructions

Opening angle of the prepared seam approx. 70°, root gap approx. 2 mm. The stick electrode is welded with a slight tilt and short arc. Use string beads welding technique. The interpass temperature of 150° C and a max. weaving width 2,5 x diameter of the stick electrode core wire should not be exceeded. Re-dry stick electrode prior welding for 2 –3 h at 250 –300° C, welding out of a hot stick electrode carrier.

## Base materials

NiCr15Fe (Inconel 600) and Ni alloys of the same or similar composition; highly creep resistant austenitic steels, e.g. X8CrNiNb16-13, X8CrNiMoNb16-16, X8CrNiMoVNB16-13, and steels of the same strength group with the same or similar composition. 1.5 to 5% Ni steels, including X8Ni9, and joints between the above-mentioned steel groups with unalloyed and low-alloy steels for use at higher temperatures, e.g. P235GH, P265GH, P235GH- P355GH, S255NB, P295GH, 16Mo3; low-alloy structural and boiler construction steels, as well as X20CrMoV12-1 and X20CrMoWV12-1 with stainless, creep resistant austenitic steels; also suitable for the Incoloy 800 material

## Typical analysis of all-weld metal (Wt-%)

C	Si	Mn	Cr	Ni	Nb	Fe
0,025	0,4	6,0	16,0	bal.	2,2	6,0

## Mechanical properties of all-weld metal

Heat Treatment	Yield strength	Tensile strength	Elongation	Impact values	
	0,2%		(L <sub>0</sub> =5d <sub>0</sub> )	in J CVN	
	MPa	MPa	%	+20°C:	-196°C:
untreated	400	670	40	120	80

## Operating data

	Polarity = +
---	--------------

Dimensions (mm)	Amperage A
2,5 x 250	50-70
3,2 x 300	70-95
4,0 x 350	90-120
5,0 x 400	120-160

## Approvals and certificates

TÜV (No. 00875), GL, DNV, KTA (No. 08036)



# UTP 7015 Mo

Stick electrode

## Classifications

nickel-based

EN ISO 14172:

AWS A5.11:

E Ni 6093 (NiCr15Fe8NbMo)

E NiCrFe-2

## Characteristics and field of use

UTP 7015 Mo is predominantly used for joining identical heat resistant NiCrFe-alloys, heat resistant austenites, cold tough Ni-steels, and for joining heat resistant austenitic-ferritic materials. Specially also used for joinings of high C content 25/35 CrNi cast steel to 1.4859 or 1.4876 for petrochemical installations with working temperatures up to 900 °C.

### Welding characteristics and special properties of the weld metal

The welding deposit of UTP 7015 Mo is hot cracking resistant, does not tend to embrittlement and is scale resistant and resistant to cavitation at high temperatures.

### Welding instructions

Hold stick electrode as vertically as possible with a short arc, only a very little weaving. Fill end crater carefully. Interpass temperature max. 150° C. Re-dry stick electrodes for 2–3 h / 250–300° C.

## Base materials

2.4816 (NiCr15 Fe), 2.4951 (NiCr 20 Ti), 1.4876 (X10 NiCrTiAl 32 20), 1.4941(X8 CrNiTi 18 10)

## Typical analysis of all-weld metal (Wt-%)

C	Si	Mn	Cr	Mo	Nb	Ni	Fe
0,04	0,4	3,0	16,0	1,5	2,2	bal.	6,0

## Mechanical properties of all-weld metal

Heat Treatment	Yield strength 0,2%	Tensile strength	Elongation (L <sub>0</sub> =5d <sub>0</sub> )	Impact values in J CVN
	MPa	MPa	%	at RT
untreated	380	620	35	80

## Operating data



Polarity = +

Dimensions (mm)	Amperage A
2,5 x 300	50-70
3,2 x 300	70-95
4,0 x 350	90-120
5,0 x 400	120-160

## Approvals and certificates

TÜV (No. 05259), GL, DNV

# UTP 7013 Mo

Stick electrode

## Classifications

nickel-based

EN ISO 14172:

AWS A5.11:

E Ni 6620 (NiCr14Mo7Fe)

ENiCrMo-6

## Characteristics and field of use

The high-nickel stick electrode UTP 7013 Mo is especially suited for welding cold-tough nickel steels, such as X8Ni9.

### Welding characteristics and special properties of the weld metal

UTP 7013 Mo is destined for welding with ac. It is weldable in all positions. Stable arc, easy slag removal.

### Welding instructions

The weld zone must be clean and properly degreased. Prior to welding, the stick electrodes must be dried for 2–3 hours at 250–300° C. The stick electrode is welded with a slight tilt, short arc and sufficiently high amperage adjustment. To avoid end crater cracks, the crater must be filled properly and the arc drawn away to the side.

## Base materials

cold-tough nickel steels, such as X8Ni9

## Typical analysis of all-weld metal (Wt-%)

C	Si	Mn	Cr	Mo	Ni	Nb	W	Fe
0,05	0,6	3,5	13,0	7,0	bal.	1,0	1,2	7,0

## Mechanical properties of all-weld metal

Heat Treatment	Yield strength 0,2%	Tensile strength	Elongation ( $L_0=5d_0$ )	Impact values in J CVN
	MPa	MPa	%	-196°C:
untreated	420	690	35	70

## Operating data



Polarity = + / ~

## Dimensions (mm)

## Amperage A

2,5 x 300	50-70
3,2 x 300	80-120
4,0 x 350	110-150
5,0 x 400	120-160

## Approvals and certificates

BV

# UTP 80 M

Stick electrode

## Classifications

nickel-based

EN ISO 14172:

AWS A5.11:

E Ni 4060 (NiCu30Mn3Ti)

E NiCu-7

## Characteristics and field of use

UTP 80 M is suitable for joining and surfacing of nickel-copper alloys and of nickel-copper-clad steels. UTP 80 M is also used for joining different materials, such as steel to copper and copper alloys, steel to nickel-copper alloys. These materials are employed in high-grade apparatus construction, primarily for the chemical and petrochemical industries. A special application field is the fabrication of seawater evaporation plants and marine equipment.

### Welding characteristics and special properties of the weld metal

UTP 80 M is weldable in all positions, except vertical-down. Smooth, stable arc. The slag is easily removed, the seam surface is smooth. The weld metal withstands sea water.

### Welding instructions

Thorough cleaning of the weld zone is essential to avoid porosity. V angle of seam about 70°, weld string beads if possible. Weld with dry stick electrodes only! Re-dry stick electrodes 2 - 3 hours at 200 °C.

## Base materials

Particularly suited for the following materials: 2.4360 NiCu30Fe, 2.4375 NiCu30Al.

## Typical analysis of all-weld metal (Wt-%)

C	Si	Mn	Ni	Cu	Ti	Al	Fe
0,05	0,7	3,0	bal.	29,0	0,7	0,3	1,0

## Mechanical properties of all-weld metal

Heat Treatment	Yield strength 0,2%	Tensile strength	Elongation ( $L_0=5d_0$ )	Impact values in J CVN
	MPa	MPa	%	at RT
untreated	300	450	30	80

## Operating data



Polarity = +

## Dimensions (mm)

## Amperage A

2,5 x 300	55-70
3,2 x 300	75-110
4,0 x 350	90-130
5,0 x 400	135-160

## Approvals and certificates

TÜV (No. 00248), ABS, GL

# Avesta P12-R basic

Stick electrode

## Classifications

nickel-based

EN ISO 14172:

AWS A5.11:

E Ni Cr 22 Mo 9

ENiCrMo-12

## Characteristics and field of use

Avesta P12-R basic is a nickel base electrode designer for welding 6Mo steels such as 254 SMO. It can also be used for welding nickel base alloys such as Inconel 625 and Incoloy 825. In chloride containing environments, the electrode offers particularly high resistance to pitting, crevice corrosion and stress corrosion cracking. To minimise the risk of hot cracking when welding fully austenitic steels and nickel base alloys, heat input and interpass temperature must be low and there must be as little dilution as possible from the parent metal.

## Base materials

For welding steels such as					
Outokumpu	EN	ASTM	BS	NF	SS
254 SMO	1.4547	S31254	-	-	2378

Also for welding nickel base alloys to stainless or unalloyed steels and for surfacing.

## Typical analysis of all-weld metal (Wt-%)

C	Si	Mn	Cr	Ni	Mo	Nb	Fe
0,02	0,4	0,4	21,5	bal.	9,5	2,2	3,0

## Mechanical properties of all-weld metal

Heat Treatment	Yield strength 0,2%	Tensile strength	Elongation ( $L_0=5d_0$ )	Impact values in J CVN		
	MPa	MPa	%	+20°C:	-40°C:	-196°C:
untreated	480	730	40	90	80	70

## Operating data



Polarity = +

Dimensions (mm)	Amperage A
2,0	25-45
2,5	40-70
3,2	60-95
4,0	90-135



## Chapter 2.1 - TIG rod (unalloyed, low-alloyed)

Product name	EN ISO	AWS	Page
B M	i		
B M	i		
nion	i		
B M	Mo i	A	
B M	rMo i	B o	
nion Mo	Mo	A	
nion rMo	rMo i		
B M	rMo i	B o	
B M	rMo	B	
er anit M	rMo	B	
nion rMo	rMo i		
nion	rMo i		
er anit M	rMo	B o	
er anit A			
B M			
B i	i	i o	
B i	i	i	

**Classifications**

unalloyed

EN ISO 636-A:

AWS A5.18:

W 42 5 W3Si1

ER70S-6

**Characteristics and field of use**

Universally applicable copper coated welding rod with a largely spatter-free material transfer. The welding rod is suitable for joint welding in the construction of boilers, containers and building structures.

BÖHLER EMK 6 is also suitable for use in acid gas (HIC test according to NACE TM-02-84). Values for the SSC test are also available.

**Marks (rods only)**

front:  W3Si1  
back: ER70S-6

**Base materials**

Steels up to a yield strength of 420 MPa (60 ksi)

S235JR-S355JR, S235JO-S355JO, S235J2-S355J2, S275N-S420N, S275M-S420M, S275NLS420NL,

S275ML-S420ML, P235GH-P355GH, P275NL1-P355NL1, P275NL2-P355NL2, P215NL, P265NL, P355N, P285NH-P420NH, P195TR1-P265TR1, P195TR2-P265TR2, P195GH-P265GH, L245NB-L415NB, L245MB-L415MB, GE200-GE240

ASTM A 106 Gr. A, B, C; A 181 Gr. 60, 70; A 283 Gr. A, C; A 285 Gr. A, B, C; A 350 Gr. LF1, LF2; A 414 Gr. A, B, C, D, E, F, G; A 501 Gr. B; A 513 Gr. 1018; A 516 Gr. 55, 60, 65, 70; A 573 Gr. 58, 65, 70; A 588 Gr. A, B; A 633 Gr. A, C, D, E; A 662 Gr. A, B, C; A 707 Gr. L1, L2, L3; A 711 Gr. 1013; A 841 Gr. A, B, C; API 5 L Gr. B, X42, X52, X56, X60

**Typical composition of welding rod (Wt-%)**

C	Si	Mn				
0,8	0,9	1,45				

**Mechanical properties of all-weld metal**

Heat Treatment	Yield strength	Tensile strength	Elongation	Impact values	
	0,2%		( $L_0=5d_0$ )	in J CVN	
	MPa	MPa	%	+20°C:	-40°C:
untreated	450	560	28	180	80
stress relieved*	400	510	28	180	110

\* 600°C/2 h – shielding gas 100% Argon

**Operating data**

Polarity = -

shielding gases: Argon

**Dimensions (mm)**

1,6	2,0	2,4	3,0
-----	-----	-----	-----

**Approvals and certificates**

TÜV-D (09717), LTSS, SEPROZ, CE

<b>Classifications</b>	unalloyed	
EN ISO 636-A:	AWS A5.18:	
W 46 5 W2Si	ER70S-3	

### Characteristics and field of use

Copper coated welding rod for welding unalloyed and low-alloy steels. The TIG rod is suitable for thin-walled plates and thin-walled tubes as well as for root welds. The relatively low Si content makes the welding rod particularly suitable for welding joints that will later be enamelled or galvanised. The TIG rods are particularly recommended for root welds (approved down to -50°C). BÖHLER EML 5 is also suitable for use in acid gas (HIC test according to NACE TM-02-84).

### Marks (rods only)

front:  W3Si1  
back: ER70S-6

### Base materials

Steels up to a yield strength of 460 MPa (67 ksi)  
S235JR-S355JR, S235JO-S355JO, S235J2-S355J2, S275N-S460N, S275M-S460M, S275NL-S460NL, S275ML-S460ML, P235GH-P355GH, P275NL1-P460NL1, P275NL2-P460NL2, P215NL, P265NL, P355N, P460N, P285NH-P460NH, P195TR1-P265TR1, P195TR2-P265TR2, P195GH-P265GH, L245NB-L415NB, L245MB-L415MB, GE200-GE240  
ASTM A 106 Gr. A, B, C; A 181 Gr. 60, 70; A 283 Gr. A, C; A 285 Gr. A, B, C; A 350 Gr. LF1, LF2; A 414 Gr. A, B, C, D, E, F, G; A 501 Gr. B; A 513 Gr. 1018; A 516 Gr. 55, 60, 65, 70; A 572 Gr. 42, 50, 55, 60, 65; A 573 Gr. 58, 65, 70; A 588 Gr. A, B; A 633 Gr. A, C, D, E; A 662 Gr. A, B, C; A 707 Gr. L1, L2, L3; A 711 Gr. 1013; A 841 Gr. A, B, C; API 5 L Gr. B, X42, X52, X56, X60

### Typical composition of welding rod (Wt-%)

C	Si	Mn		
0,01	0,6	1,2		

### Mechanical properties of all-weld metal

Heat Treatment	Yield strength	Tensile strength	Elongation ( $L_0=5d_0$ )	Impact values in J CVN		
	0,2%					
	MPa	MPa	%	+20°C:	-20°C:	-50°C:
untreated	520	620	26	220	200	90
stress relieved*	480	580	28	200	210	

\* 600°C/2 h – shielding gas 100% Argon

### Operating data



Polarity = -

### Dimensions (mm)

1,6	2,0	2,4	3,0
-----	-----	-----	-----

### Approvals and certificates

TÜV-D (1096.), DB (42.014.02), Statoil, CE



# Union I 52

TIG rod

## Classifications

unalloyed

EN ISO 636-A

AWS A5.18:

W 42 5 W3Si1

ER70S-6

## Characteristics and field of use

GTAW solid rod and wire for the welding with argon. Typical fields of use: boiler, tank and pipeline constructions and apparatus engineering.

## Marks (rods only)



## Base materials

Unalloyed structural steels acc. to EN 10025: S185, S235JR, S235JRG1, S235JRG2, S275JR, S235J0, S275J0, S355J0. Boiler steels P235GH, P265GH, P295GH, P355GH.  
 Fine grained structural steels up to S420N. ASTM A27 and A36 Gr. all; A214; A242 Gr. 1-5; A266 Gr. 1, 2, 4; A283 Gr. A, B, C, D; A285 Gr. A, B, C; A299 Gr. A, B; A328; A366; A515 Gr. 60, 65, 70; A516 Gr. 55; A570 Gr. 30, 33, 36, 40, 45; A572 Gr. 42, 50; A606 Gr. all; A607 Gr. 45; A656 Gr. 50, 60; A668 Gr. A, B; A907 Gr. 30, 33, 36, 40, A841; A851 Gr. 1, 2; A935 Gr. 45; A936 Gr. 50; API 5 L Gr. B, X42-X56.

## Typical composition of welding rod (Wt-%)

C	Si	Mn		
0,08	0,85	1,5		

## Mechanical properties of all-weld metal

Heat Treatment	Yield strength	Tensile strength	Elongation ( $L_0=5d_0$ )	Impact values in J CVN	
	0,2%			at room temperature	
Shielding gas	MPa	MPa	%		-50°C:
I1	440	560	25	130	50

## Operating data



Polarity = -

Shielding gas (EN ISO 14175) I 1-3

## Dimensions (mm)

1,6	2,0	2,4	3,0
-----	-----	-----	-----

## Approvals and certificates

TÜV (Certificate No. 1656) DB (Reg. form No. 42.132.11) DNV

**BÖHLER DMO-IG**

TIG rod

<b>Classifications</b>	low-alloy	
EN ISO 21952-A:	EN ISO 636-A:	AWS A5.28:
W MoSi	W2Mo (for rod)	ER70S-A1 (ER80S-G)

**Characteristics and field of use**

TIG welding rod, copper coated for welding in boiler making, pressure vessel and pipeline construction, crane building and steel construction. High-quality, very tough and crack-resistant weld metal, resistant to ageing. Suitable for the temperature range from -30°C to 500°C (550°C). Very good welding and flow behaviour.

**Marks (rods only)**

front:  WMoSi  
back: 1.5424

**Base materials**

creep-resistant steels and cast steels of the same type, steels resistant to ageing and to caustic cracking 16Mo3, 20MnMoNi4-5, 15NiCuMoNb5, S235JR-S355JR, S235JO-S355JO, S450JO, S235J2-S355J2, S275N-S460N, S275M-S460M, P235GH-P355GH, P355N, P285NH-P460NH, P195TR1-P265TR1, P195TR2-P265TR2, P195GH-P265GH, L245NB-L415NB, L450QB, L245MB-L450MB, GE200-GE300 ASTM A 29 Gr. 1013, 1016; A 106 Gr. C; A, B; A 182 Gr. F1; A 234 Gr. WP1; A 283 Gr. B, C, D; A 335 Gr. P1; A 501 Gr. B; A 533 Gr. B, C; A 510 Gr. 1013; A 512 Gr. 1021, 1026; A 513 Gr. 1021, 1026; A 516 Gr. 70; A 633 Gr. C; A 678 Gr. B; A 709 Gr. 36, 50; A 711 Gr. 1013; API 5 L B, X42, X52, X60, X65

**Typical composition of welding rod (Wt-%)**

C	Si	Mn	Mo	
0,1	0,6	1,1	0,5	

**Mechanical properties of all-weld metal**

Heat Treatment	Yield strength 0,2%	Tensile strength	Elongation ( $L_0=5d_0$ )	Impact values in J CVN	
Shielding gas	MPa	MPa	%	+20°C:	-30°C:
untreated	530	650	26	200	80
annealed*	480	570	27	230	

\*annealed, 620°C/1 h/furnace down to 300°C/air – shielding gas Argon

**Operating data**

	Polarity = -	shielding gas: 100% Argon
---	--------------	---------------------------

**Dimensions (mm)**

1,6	2,0	2,4	3,0
-----	-----	-----	-----

**Approvals and certificates**

TÜV-D (0020.), KTA 1408.1 (8066.), DB (42.014.09), BV (UP), DNV (I MS), CRS (3), CE, NAKS

**Similar alloy filler metals**

GMAW solid wire:	DMO-IG	SAW combination:	EMS 2 Mo/BB 24, EMS 2 Mo/BB 306, EMS 2 Mo/BB 400
SMAW electrode:	FOX DMO Kb FOX DMO Ti		EMS 2 Mo/BB 418 TT
Flu cored wire:	DMO Ti-FD		EMS 2 Mo/BB 421 TT

**BÖHLER DCMS-IG**

TIG rod

**Classifications**

low-alloyed

EN ISO 21952-A

AWS A5.28

W CrMo1Si

ER80S-B2 (mod.)

**Characteristics and field of use**

TIG welding rods, copper coated for welding in boiler, pressure vessel and pipeline construction, also for welding work with quenched and tempered and case-hardening steels. Preferred for 13CrMo4-5. Approved for long-term use at operating temperatures of up to +570°C. Suitable for step cooling applications (Bruscato ≤ 15 ppm). The weld metal exhibits high quality, good toughness and crack resistance; it is resistant to caustic cracking, can be nitrated and is suitable for quenching and tempering. The creep strength is in the same range as the 13CrMo4-5 material. Very good welding and flow behaviour.

**Marks (rods only)**

front:  W CrMo1 Si  
back: 1.7339

**Base materials**

same alloy creep resistant steels and cast steel, case-hardening and nitriding steels with comparable composition, heat treatable steels with comparable composition, steels resistant to caustic cracking 1.7335 13CrMo4-5, 1.7262 15CrMo5, 1.7728 16CrMoV4, 1.7218 25CrMo4, 1.7225 42CrMo4, 1.7258 24CrMo5, 1.7354 G22CrMo5-4, 1.7357 G17CrMo5-5 ASTM A 182 Gr. F12; A 193 Gr. B7; A 213 Gr. T12; A 217 Gr. WC6; A 234 Gr. WP11; A335 Gr. P11, P12; A 336 Gr. F11, F12; A 426 Gr. CP12

**Typical composition of welding rod (Wt-%)**

C	Si	Mn	Cr	Mo	P	As	Sb	Sn
0,1	0,6	1,0	1,2	0,5	≤0,015	≤0,010	≤0,005	≤0,006

**Mechanical properties of all-weld metal**

Heat Treatment	Yield strength 0,2%	Tensile strength	Elongation ( $L_0=5d_0$ )	Impact values in J CVN
	MPa	MPa	%	+20°C:
annealed *	440	570	25	250
annealed 1**	510	620	22	200

\*680°C/2 h/furnace down to 300°C/air – shielding gas Argon; \*\* 620°C/1 h/furnace down to 320°C/air – shielding gas Argon

**Operating data**

Polarity = -

shielding gas: 100% Argon

**Dimensions (mm)**

1,6	2,0	2,4	3,0
-----	-----	-----	-----

**Approvals and certificates**

TÜV-D (1096.), DB (42.014.02), Statoil, CE

**Similar alloy filler metals**

GMAW solid wire:	DMO-IG	Flu cored wire:	DMO Ti-FD
SMAW electrode:	FOX DMO Kb FOX DMO Ti	SAW combination:	EMS 2 CrMo/BB 24 EMS 2 CrMo/BB 24 SC EMS 2 CrMo/BB 418 TT
Gas welding rod:	DCMS		

**Union I Mo**

TIG rod

**Classifications**

low-alloyed

EN ISO 636-A:

AWS A5.28

W 46 3 W2Mo

ER80S-G(A1)

**Characteristics and field of use**

Medium alloyed welding rod/wire for the welding with argon. Suited for low alloy and creep resistant steels in pipe and tank construction.

**Marks (rods only)**

W MoSi / ER80S-G (A1)

**Base materials**

P235GH, P265GH, P295GH, 16 Mo 3, 17 MnMoV 64, 15 NiCuMoNb 5, 20 MnMo 45, 20 MnMoNi 55, Fine grained structural steels up to S460N, Pipe steels acc. to EN 10216 T2: P235GH, P265GH ASTM A335 Gr. P1; A161-94 Gr. T1 A, A182M Gr. F1; A204M Gr. A, B, C; A250M Gr. T1; A217 Gr. WC1

**Typical composition of welding rod (Wt-%)**

C	Si	Mn	Mo
0,1	0,6	1,15	0,5

**Mechanical properties of all-weld metal**

	Yield strength 0,2%	Tensile strength	Elongation ( $L_0=5d_0$ )	Impact values in J CVN	
Shielding gas	MPa	MPa	%	at room temperature	-30°C:
I1	480	570	23	110	47

**Operating data**

Polarity = -

Shielding gas (EN ISO 14175) I 1-3

**Dimensions (mm)**

1,6	2,0	2,4	3,0
-----	-----	-----	-----

**Approvals and certificates**

TÜV (Certificate No. 1250) DB (Reg. form No. 42.132.43)

**Union I CrMo**

TIG rod

**Classifications**

low-alloyed

EN ISO 21952-A

AWS A5.28

W CrMo1Si

ER80S-G

**Characteristics and field of use**

Welding rod/wire for the welding with argon. Suitable for manufacturing creep resistant steels in boiler, tank, pipeline and nuclear reactor construction.

**Marks (rods only)**

W CrMo1Si / W IV

**Base materials**

1.7335 – 13CrMo4-5, ASTM A193 Gr. B7; 1.7357 – G17CrMo5-5, A217 Gr. WC6; A335 Gr. P11 and P12

**Typical composition of welding rod (Wt-%)**

C	Si	Mn	Cr	Mo
0,1	0,6	1,0	1,1	0,5

**Mechanical properties of all-weld metal**

	Yield strength 0,2%	Tensile strength	Elongation ( $L_0=5d_0$ )	Impact values in J CVN
Shielding Gas	MPa	MPa	%	at room temperature
A1	450	560	22	90

**Operating data**

Polarity = -

Shielding gas (EN ISO 14175) I 1-3

**Dimensions (mm)**

0,8	2,0	2,5	3,0
-----	-----	-----	-----

**Approvals and certificates**

TÜV (Certificate No. 0906) DB (Reg. form No. 42.132.44)

# BÖHLER CM 2-IG

TIG rod

Classifications		low-alloyed
EN ISO 21952-A	AWS A5.28	
W CrMo2Si	ER90S-B3 (mod.)	

## Characteristics and field of use

TIG welding rod, copper coated for welding in boiler, pressure vessel and pipeline construction, and for the petrochemical industry, e.g. cracking plants. Preferred for 10CrMo9-10, and also suitable for similar-alloy quenched and tempered and case-hardening steels. Approved for long-term use at operating temperatures of up to +600°C. The weld metal exhibits high quality, good toughness and crack resistance, as well as a creep strength very much in the same range as 10CrMo9-10. Very good welding and flow behaviour.

## Marks (rods only)

front:  W CrMo2 Si  
back: 1.7384

## Base materials

same type as creep-resistant steels and cast steels, similar alloy quenched and tempered steels up to 980 MPa strength, similar alloy case-hardening and nitriding steels 1.7380 10CrMo9-10, 1.7276 10CrMo11, 1.7281 16CrMo9-3, 1.7383 11CrMo9-10, 1.7379 G17CrMo9-10, 1.7382 G19CrMo9-10 ASTM A 182 Gr. F22; A 213 Gr. T22; A 234 Gr. WP22; 335 Gr. P22; A 336 Gr. F22; A 426 Gr. CP22

## Typical composition of welding rod (Wt-%)

C	Si	Mn	Cr	Mo	P	As	Sb	Sn
0,08	0,6	0,9	2,5	1,0	≤0.010	≤0,010	≤0,005	≤0,006

## Mechanical properties of all-weld metal

Heat Treatment	Yield strength 0,2%	Tensile strength	Elongation (L <sub>0</sub> =5d <sub>0</sub> )	Impact values in J CVN
	MPa	MPa	%	+20°C:
annealed *	470	600	23	190

(\*) annealed, 720°C/2 h/furnace down to 300°C/air – shielding gas Argon

## Operating data

	Polarity = -	shielding gas: 100% Argon
---	--------------	---------------------------

## Dimensions (mm)

1,6	2,0	2,4	3,0
-----	-----	-----	-----

## Approvals and certificates

TÜV-D (1564.), SEPPOZ, CE, NAKS (Ø2.4 mm; Ø3.0 mm)

## Similar alloy filler metals

GMAW solid wire:	CM 2-IG	Flu cored wire:	CM 2 Ti-FD
SMAW electrode:	FOX CM 2 Kb SC FOX CM 2 Kb	SAW combination:	CM 2-UP/BB 24 CM 2 SC-UP/BB 24 SCEMS 2 CM 2-UP/BB 418 TT

**BÖHLER C 9 MV-IG**

TIG rod

**Classifications**

high-alloyed

EN ISO 21952-A

AWS A5.28

W CrMo91

ER90S-B9

**Characteristics and field of use**

TIG welding rod for highly creep resistant, quenched and tempered 9-12% chrome steels, particularly for T91/P91 steels in turbine and boiler construction and in the chemical industry. Approved for long-term use at operating temperatures of up to +650°C.

**Marks (rods only)**

front:  WCrMo91  
back: ER 90S-B9

**Base materials**

same type as highly creep resistant steels 1.4903 X10CrMoVNb9-1, GX12CrMoVNbN9-1  
ASTM A 335 Gr. P91, A 336 Gr. F91, A 369 Gr. FP91, A 387 Gr. 91, A 213 Gr. T91

**Typical composition of welding rod (Wt-%)**

C	Si	Mn	Cr	Ni	Mo	V	Nb
0,1	0,3	0,5	9,0	0,5	0,9	0,2	0,06

**Mechanical properties of all-weld metal**

Heat Treatment	Yield strength 0,2%	Tensile strength	Elongation ( $L_0=5d_0$ )	Impact values in J CVN	
	MPa	MPa	%	+20°C:	
annealed *	640	760	19	150	

(\* ) annealed, 760°C/2 h/furnace down to 300°C/air – shielding gas Argon

**Operating data**

Polarity = -

shielding gas: 100% Argon

**Dimensions (mm)**

2,0

2,4

**Approvals and certificates**

TÜV-D (07106.), CE, NAKS (Ø2.4 mm; Ø3.0 mm)

**Similar alloy filler metals**

GMAW solid wire:	C 9 MV-IG	Flu cored wire:	C 9 MV Ti-FD
SMAW electrode:	FOX C 9 MV	SAW combination:	C 9 MV-UP/BB 910
Metal cored wire:	C 9 MV-MC		

# Thermanit MTS 3

TIG rod

<b>Classifications</b>	low-alloyed	
EN ISO 21952-A	AWS A5.28	
W CrMo91	ER90S-B9	

## Characteristics and field of use

High temperature resistant, resistant to scaling up to 600 °C (1112 °F). Suited for joining and surfacing applications with quenched and tempered 9 % Cr steels, particularly for matching high temperature resistant parent metal T91 / P91 according to ASTM.

## Marks (rods only)



W CrMo91 / ER90S-B9

## Base materials

1.4903 – X10CrMoVNb9-1; ASTM A199 Gr. T91; A355 Gr. P91(T91); A213/213M Gr. T91

## Typical composition of welding rod (Wt-%)

C	Si	Mn	Cr	Ni	Mo	V	Nb
0,1	0,3	0,5	9,0	0,7	1,0	0,2	0,06

## Mechanical properties of all-weld metal

Heat Treatment	Yield strength 0,2%	Tensile strength	Elongation ( $L_0=5d_0$ )	Impact values in J CVN		
	MPa	MPa	%	+20°C:		
760 C / 2 h	530	620	19	150		

## Operating data



Polarity = -

Shielding gas (EN ISO 14175) I1

## Dimensions (mm)

1,6	2,0	2,4	3,2
-----	-----	-----	-----

## Approvals and certificates

TÜV (Certificate No. 6166)



**Union I CrMo 910**

TIG rod

**Classifications**

low-alloyed

EN ISO 21952-A

AWS A5.28

W CrMo2Si

ER90S-G

**Characteristics and field of use**

Medium alloyed welding rod/wire for the welding with argon. Suitable for manufacturing creep resistant steels in boiler, tank, pipeline and nuclear reactor construction.

**Marks (rods only)**

W CrMo2 Si / 1.7384

**Base materials**

1.7380 – 10 CrMo 910, ASTM A355 Gr- P22; 1.7379 – G17CrMo9-10, A217 Gr. WC9

**Typical composition of welding rod (Wt-%)**

C	Si	Mn	Cr	Mo
0,047	0,6	1,0	2,55	1,0

**Mechanical properties of all-weld metal**

	Yield strength 0,2%	Tensile strength	Elongation ( $L_0=5d_0$ )	Impact values in J CVN		
Shielding gas	MPa	MPa	%	at room temperature		
I1	470	590	20	80		

**Operating data**

Polarity = -

Shielding gas (EN ISO 14175) I 1-3

**Dimensions (mm)**

2,0

2,5

3,0

**Approvals and certificates**

TÜV (Certificate No. 0908) DB (Reg. form No. 42.132.41)

# Union I P24

TIG rod

## Classifications

low-alloyed

EN ISO 21952-A

AWS A5.28

WZ CrMo2VTi/Nb

ER90S-G

## Characteristics and field of use

Medium alloyed welding rod / wire for the welding with Argon. Suitable for creep resistant tubes and pipes in power stations, especially 7CrMoVTi B10-10 (T24/P24)

## Marks (rods only)



T / P24 / ER90S-G

## Base materials

1.7378 – 7 CrMoVTiB 10-10; (P24/T24)

## Typical composition of welding rod (Wt-%)

C	Si	Mn	Cr	Mo	V	Ti/Nb
0,05	0,3	0,5	2,2	1,0	0,22	0,04

## Mechanical properties of all-weld metal

Heat Treatment	Yield strength 0,2%	Tensile strength	Elongation ( $L_0=5d_0$ )	Impact values in J CVN
	MPa	MPa	%	at room temperature
AW	600	700	15	47
740 C / 2 h	500	620	20	100

## Operating data



Polarity = -

Shielding gas (EN ISO 14175) I 1-3

## Dimensions (mm)

Spools	0,8	D100, B300		
	1,0	B300		
	1,2	B300		
Rods	1,6	2,0	2,4	3,2

## Approvals and certificates

TÜV (Approvals Certificate No. 10157)

# Thermanit MTS 616

TIG rod

<b>Classifications</b>	low-alloyed		
EN ISO 21952-A	AWS A5.28		
WZ CrMoWVNb 9 0,5 1,5	ER90S-G ER90S-B9(mod.)		

## Characteristics and field of use

High temperature resistant. Suited for joining and surfacing applications with matching high temperature resistant parent metal P92 according to ASTM A 335.

## Marks (rods only)



## Base materials

ASTM A 355 Gr. P92, NF 616, ASTM A 355 Gr. P92 (T92); A213 Gr. 92, 1.4901 X10CrWMoVNb9-2

## Typical composition of welding rod (Wt-%)

C	Si	Mn	Cr	Mo	Ni	W	V	Nb	N
0,1	0,25	0,5	8,5	0,4	0,5	1,6	0,2	0,06	0,04

## Mechanical properties of all-weld metal

Heat Treatment	Yield strength 0,2%	Tensile strength	Elongation ( $L_0=5d_0$ )	Impact values in J CVN
	MPa	MPa	%	at room temperature
760°C/≥2 h	560	720	15	41

## Operating data

	Polarity = -	Shielding gas (EN ISO 14175) I1
--	--------------	---------------------------------

## Dimensions (mm)

Spools	0,8	D200		
Rods	1,6	2,0	2,4	3,2

## Approvals and certificates

TÜV (Certificate No. 9290)

# Thermanit ATS 4

TIG rod

<b>Classifications</b>	low-alloyed	
EN ISO 14343-A	AWS A5.9	
W 19 9 H	ER19-10H	

## Characteristics and field of use

High temperature resistant up to 700 °C (1292 °F); resistant to scaling up to 800 °C (1472 °F). For surfacing and joining applications on matching/similar high temperature resistant steels/cast steel grades.

## Marks (rods only)



W 19 9 H / ER19-10 H

## Base materials

TÜV-certified parent metal 1.4948 – X6CrNi18-11 1.4878 – X12CrNiTi8-9  
1.4850 – X6CrNiNb18-10 AISI 304H, 321H, 347H

## Typical composition of welding rod (Wt-%)

C	Si	Mn	Cr	Ni
0,05	0,4	1,8	18,8	9,3

## Mechanical properties of all-weld metal

Heat Treatment	Yield strength 0,2%	Tensile strength	Elongation ( $L_0=5d_0$ )	Impact values in J CVN
	MPa	MPa	%	at room temperature
AW	400	600	30	100

## Operating data

	Polarity = -	Shielding gas (EN ISO 14175) I1
--	--------------	---------------------------------

## Dimensions (mm)

1,6	2,0	2,4	3,2
-----	-----	-----	-----

## Approvals and certificates

TÜV Approvals (Certificate No. 1616)

## Classifications

low-alloyed

EN 12536

AWS A5.4

O IV

R60-G

## Characteristics and field of use

Copper coated, Mo-alloyed gas welding rod, preferred for pipe welding with strict inspection requirements. Viscous weld pool. Approved for long-term use at operating temperatures of up to +500°C.

## Marks (rods only)

front:  O IV 2.0  
back: R60-G

## Base materials

Unalloyed and creep resistant structural steels with yield strengths up to 295 MPa. 16Mo3, S235JR-S275JR, S275N, S275M, P195GH-P295GH, P195TR1-P265TR1, P195TR2-P265TR2, GE200-GE240 ASTM A 29 Gr. 1013, 1016; A 106 Gr. C; A; A 182 Gr. F1; A 283 Gr. B, C; A 501 Gr. B; A 510 Gr. 1013; A 512 Gr. 1021, 1026; A 513 Gr. 1021, 1026; A 633 Gr. C; A 709 Gr. 36, 50; A 711 Gr. 1013

## Typical composition of welding rod (Wt-%)

C	Si	Mn		
0,01	0,6	1,2		

## Mechanical properties of all-weld metal

Heat Treatment	Yield strength 0,2%	Tensile strength	Elongation ( $L_0=5d_0$ )	Impact values in J CVN
	MPa	MPa	%	+20°C:
untreated	330	470	24	60

## Operating data

## Dimensions (mm)

1,6	2,0	2,4	3,0

## Approvals and certificates

TÜV-D (0146.), DB (70.014.03), SEPROZ, CE

**BÖHLER Ni 1-IG**

TIG rod

**Classifications**

low-alloyed

EN ISO 636-A:

AWS A5.28

W3Ni1

ER80S-Ni1 (mod.)

**Characteristics and field of use**

Ni-alloy TIG welding rod for high-quality welding in the offshore field and applications with high requirements for low-temperature toughness down to -50°C.

**Marks (rods only)**

front:  W3Ni1  
back: ER80S-Ni 1 (mod.)

**Base materials**

Cryogenic, high-strength steels up to a yield strength of 460 MPa S275N-S460N, S275NL-S460NL, S275M-S460M, S275ML-S460ML, P355N, P355NH, P460N, P460NH, P275NL1-P460NL1, P275NL2-P460NL2, L360NB, L415NB, L360MB-L450MB, L360QB-L450QB ASTM A 203 Gr. D, E; A 350 Gr. LF1, LF2, LF3; A 420 Gr. WPL3, WPL6; A 516 Gr. 60, 65, 70; A 572 Gr. 42, 50, 55, 60, 65; A 633 Gr. A, D, E; A 662 Gr. A, B, C; A 707 Gr. L1, L2, L3; A 738 Gr. A; A 841 A, B, C; API 5 L X52, X60, X65, X52Q, X60Q, X65Q

**Typical composition of welding rod (Wt-%)**

C	Si	Mn	Ni	
0,07	0,7	1,4	0,9	

**Mechanical properties of all-weld metal**

Heat Treatment	Yield strength	Tensile strength	Elongation ( $L_0=5d_0$ )	Impact values	
	0,2%			in J CVN	
	MPa	MPa	%	+20°C:	-50°C:
untreated	500	600	25	150	(≥ 47)

**Operating data**

	Polarity = -	shielding gas: 100% Argon
--	--------------	---------------------------

**Dimensions (mm)**

2,0	2,4		
-----	-----	--	--

**Approvals and certificates**

**BÖHLER 2,5 Ni-IG**

TIG rod

**Classifications**

low-alloyed

EN ISO 636-A:

AWS A5.28

W2Ni2 (for rod)

ER80S-Ni2

**Characteristics and field of use**

Ni-alloy TIG welding rod, copper coated for welding cryogenic fine-grained structural steels and nickel steels. The TIG method is particularly suitable for thin sheet and root runs. Cryogenic down to -80 °C.

**Marks (rods only)**

front:  W2Ni2 2.4  
back: ER80S-Ni 2

**Base materials**

Steels up to a yield strength of 460 MPa (67 ksi)  
S235JR-S355JR, S235JO-S355JO, S235J2-S355J2, S275N-S460N, S275M-S460M, S275NL-S460NL, S275ML-S460ML, P235GH-P355GH, P275NL1-P460NL1, P275NL2-P460NL2, P215NL, P265NL, P355N, P460N, P285NH-P460NH, P195TR1-P265TR1, P195TR2-P265TR2, P195GH-P265GH, L245NB-L415NB, L245MB-L415MB, GE200-GE240  
ASTM A 106 Gr. A, B, C; A 181 Gr. 60, 70; A 283 Gr. A, C; A 285 Gr. A, B, C; A 350 Gr. LF1, LF2; A 414 Gr. A, B, C, D, E, F, G; A 501 Gr. B; A 513 Gr. 1018; A 516 Gr. 55, 60, 65, 70; A 572 Gr. 42, 50, 55, 60, 65; A 573 Gr. 58, 65, 70; A 588 Gr. A, B; A 633 Gr. A, C, D, E; A 662 Gr. A, B, C; A 707 Gr. L1, L2, L3; A 711 Gr. 1013; A 841 Gr. A, B, C; API 5 L Gr. B, X42, X52, X56, X60

**Typical composition of welding rod (Wt-%)**

C	Si	Mn	Ni
0,08	0,6	1,0	2,4

**Mechanical properties of all-weld metal**

Heat Treatment	Yield strength 0,2%	Tensile strength	Elongation ( $L_0=5d_0$ )	Impact values in J CVN		
	MPa	MPa	%	+20°C:	-60°C:	-80°C:
untreated	510	600	26	280	80	(≥ 47)

**Operating data**

Polarity = -

shielding gas: 100% Argon

**Dimensions (mm)**

2,0	2,4	3,0
-----	-----	-----

**Approvals and certificates**

TÜV-D (01081.), BV (SA 3 M; UP), GL (6 46), Statoil, SEPZOIL, CE

**Similar alloy filler metals**

GMAW solid wire:	2.5 Ni-IG	SAW combination:	Ni 2-UP/BB 24
SMAW electrode:	FOX 2.5 Ni		Ni 2-UP/BB 421 TT

## Chapter 2.2 - TIG rod (high-alloyed)

Product name	EN ISO	AWS	Page
B A	Mn	o	
er anit	Mn	o	
A esta M			
A esta i M i	i	i	
er anit J			
er anit J i	i	i	
B			
er anit			
A esta i	i	i	
er anit		o	
B FF		o	
A esta			
A esta i i	i	i	
B A M			
er anit			
er anit i	i	i	
B A			
er anit A			
A esta i i	i	o	
B A			
er anit			
B		iMo o	
A esta			
B			
er anit			
A esta			
A esta		Mo o	
A esta			
B			
er anit			
er anit			
B FA			
B FFB	Mn	o	
A Mn	Mn		
A	r		
A			
er anit	i i r Fe		
A esta	i i r Mo	i rMo	
B iBA	i i r Mo	i rMo	
er anit	i i r Mo	i rMo	
A Mo	i i r Mo	i rMo	
B iBA	i i r Mn	i r	
er anit icro	i i r Mn	i r	
A	i i r Mn	i r	
er anit	i i r o Mo	i r oMo	
A o	i i r o Mo	i r oMo	
A	i i r Mo Fe	i rMo	
er anit iMo	i i r Mo	i rMo	
A	i i r Mo	i rMo	
A M	i i Mn i	i	



# BÖHLER A 7 CN-I

TIG rod

## Classifications

high-alloyed

EN ISO 14343-A:

AWS A5.9:

W 18 8 Mn

ER307 (mod.)

## Characteristics and field of use

TIG welding rod for joints between dissimilar steels, steels that are hard to weld and 14% Mn steels. Well suited for tough intermediate layers in case of hardfacing, wear-resistant and corrosion-resistant surfacings on rail and points components, valve seats and cavitation protection armour in hydro-electric machines. Properties of the weld metal: suitable for strain-hardening, very good cavitation resistance, crack resistant, resistant to thermal shock, resistant to scaling up to 850°C, little or no tendency to sigma-phase embrittlement above 500°C, cryogenic down to -110°C. Heat treatment is possible. Consultation with the manufacturer is recommended for operating temperatures above +650°C. Very good welding and flow behaviour.

## Marks (rods only)

front:  W 18 8 Mn  
back: 1.4370

## Base materials

high-strength, unalloyed and alloyed structural, quenched and tempered and armour steels among themselves or among each other; unalloyed and alloyed boiler or structural steels with high-alloy Cr and Cr-Ni steels; heat-resistant steels up to 850°C; austenitic manganese steels together and with other steels; cryogenic plate and pipe steels together with cryogenic austenitic materials.

## Typical composition of welding rod

C	Si	Mn	Cr	Ni		
0,07	0,8	6,8	19,2	8,8		

## Mechanical properties of all-weld metal

Heat Treatment	Yield strength 0,2%	Tensile strength	Elongation ( $L_0=5d_0$ )	Impact values in J CVN	
	MPa	MPa	%	+20°C:	-110°C:
untreated	460	650	38	120	≥ 32

## Operating data

	Polarity = -	shielding gases: Argon
---	--------------	------------------------

## Dimensions (mm)

1,6	2,0	2,4	
-----	-----	-----	--

## Approvals and certificates

TÜV-D (00023.), DNV (X), GL (4370), DB (43.014.28), CE, NAKS, VG 95132

## Similar alloy filler metals

SMAW electrode:	FOX A 7 / FOX A 7 CN* FOX A 7-A	Flu cored wire:	A 7-MC, A 7-FD, A 7 PW-FD
GMAW solid wire:	A 7-IG / A 7 CN-IG*	SAW combination:	A 7 CN-UP/BB 203

# Thermanit X

TIG rod

## Classifications

high-alloyed

EN ISO 14343-A

AWS A5.9

W 18 8 Mn

ER307 (mod.)

## Characteristics and field of use

Stainless. Resistant to scaling up to 850 °C (1562 °F). No adequate resistance against sulphureous combustion gases at temperatures above 500 °C (932 °F). For joining and surfacing applications with heat resistant Cr-steels/cast steel grades and heat resistant austenitic steels/cast steel grades. Well suited for fabricating austenitic-ferritic joints – max. application temperature 300 °C (572 °F). For joining unalloyed/low-alloy or Cr-steels/cast steel grades to austenitic steels. Low heat input required in order to avoid brittle martensitic transition zones.

## Marks (rods only)

front:  W 18 8 Mn  
back: 1.4370

## Base materials

### TÜV-certified parent metal

1.4583 – X10CrNiMoNb18-12 and included parent metals combined with ferritic steels up to boiler plate P295GH. High tensile, unalloyed and alloyed structural, quenched and tempered, and armour steels, same parent metal or in combination; unalloyed and alloyed boiler or structural steels with high alloyed Cr and CrNi steels; heat resistant steels up to 850 °C (1562 °F); austenitic high manganese steel with matching and other steels. Cryogenic sheet metals and pipe steels in combination with austenitic parent metals.

## Typical composition of welding rod (Wt-%)

C	Si	Mn	Cr	Ni	
0,08	0,8	7,0	19,0	9,0	

## Mechanical properties of all-weld metal

Heat Treatment	Yield strength 0,2%	Tensile strength	Elongation ( $L_0=5d_0$ )	Impact values
	MPa			MPa
untreated	450	620	35	at room temperature 100

## Operating data



Polarity = -

Shielding gas (EN ISO 14175) I1

## Dimensions (mm)

1,0	1,6	2,0	2,4	3,2
-----	-----	-----	-----	-----

## Approvals and certificates

TÜV (Certificate No. 1234) DB (Reg. form No. 43.132.26), DNV

# Avesta 308L/MVR

TIG rod

## Classifications

high-alloyed

EN ISO 14343-A:	AWS A5.9:		
W 19 9 L	ER308L		

## Characteristics and field of use

Avesta 308L/MVR is designed for welding 1.4301/ASTM 304 type stainless steels. It can also be used for welding steels that are stabilized with titanium or niobium, such as 1.4541/ASTM 321 and 1.4550/ASTM 347 in cases where the construction will be operating at temperatures below 400°C. For higher temperatures a niobium stabilised consumable such as Avesta 347-Si/MVNb-Si is required. Avesta 308L/MVR is also available with high silicon content (308L-Si/MVR-Si). The higher silicon content will improve fluidity and minimise the spatter, giving a nicer weld bead appearance.

### Corrosion resistance:

Very good under fairly severe conditions, e.g. in oxidising acids and cold or dilute reducing acids.

## Base materials

For welding steels such as

Outokumpu	EN	ASTM	BS	NF	SS
4301	1.4301	304	304S31	Z7 CN 18-09	2333
4307	1.4307	304L	304S11	Z3 CN 18-10	2352
4311	1.4311	304LN	304S61	Z3 CN 18-10 Az	2371
4541	1.4541	321	321S31	Z6 CNT 18-10	2337

## Typical composition of welding rod (Wt-%)

C	Si	Mn	Cr	Ni		
0,02	0,4	1,7	20,0	10,0		

Ferrite 8 FN; WRC -92, 10FN;WRC-92

## Mechanical properties of all-weld metal

Heat Treatment	Yield strength	Tensile strength	Elongation	Impact values		
	0,2%		( $L_0=5d_0$ )	in J CVN		
	MPa	MPa	%	+20°C:	-40°C:	-196°C:
untreated	460	620	33	130	120	70

## Operating data



Ar (99.95%) or Ar with an addition of 20 – 30% helium (He) or 1 – 5% hydrogen (H<sub>2</sub>). The addition of helium (He) and hydrogen (H<sub>2</sub>) will increase the energy of the arc. Gas flow rate 4 – 8 l/min.

## Dimensions (mm)

1,2	1,6	2,0	2,4	3,2
-----	-----	-----	-----	-----

# Avesta 308L-Si/MVR-Si

TIG rod

## Classifications

high-alloyed

EN ISO 14343-A

AWS A5.9

W 19 9 L Si

ER308LSi

## Characteristics and field of use

Avesta 308L-Si/MVR-Si is designed for welding 1.4301/ASTM 304 type stainless steels. It can also be used for welding steels that are stabilised with titanium or niobium, such as 1.4541/ASTM 321 and 1.4550/ASTM 347 in cases where the construction will be operating at temperatures below 400°C. For higher temperatures a niobium stabilized consumable such as Avesta 347-Si/MVNb-Si is required.

## Base materials

For welding steels such as

Outokumpu	EN	ASTM	BS	NF	SS
4301	1.4301	304	304S31	Z7 CN 18-09	2333
4307	1.4307	304L	304S11	Z3 CN 18-10	2352
4311	1.4311	304LN	304S61	Z3 CN 18-10 Az	2371
4541	1.4541	321	321S31	Z6 CNT 18-10	2337

## Typical composition of welding rod (Wt-%)

C	Si	Mn	Cr	Ni	
0,02	0,85	1,8	20,0	10,5	

## Mechanical properties of all-weld metal

Heat Treatment	Yield strength 0,2%	Tensile strength	Elongation ( $L_0=5d_0$ )	Impact values in J CVN	
	MPa			MPa	%
untreated	470	640	34	140	80

## Operating data



### Shielding gas

Ar (99,95%) or Ar with an addition of 20 - 30% helium (He) or 1 - 5% hydrogen ( $H_2$ ). The addition of helium (He) and hydrogen ( $H_2$ ) will increase the energy of the arc. Gas flow rate 4 - 8l/min.

## Dimensions (mm)

1,0	1,2	1,6	2,0	2,4	3,2	4,0
-----	-----	-----	-----	-----	-----	-----

**Thermanit JE-308L**

TIG rod

**Classifications**

high-alloyed

EN ISO 14343-A:

AWS A5.9:

W 19 9 L

ER308L

**Characteristics and field of use**

Stainless; resistant to intercrystalline corrosion and wet corrosion up to 350 °C (662 °F). Corrosion-resistant similar to matching low-carbon and stabilized austenitic 18/8 CrNi(N) steels/cast steel grades. High toughness at subzero temperatures as low as -196 °C (-321 °F). For joining and surfacing applications with matching and similar – stabilized and non-stabilized – austenitic CrNi(N) and CrNiMo(N) steels/cast steel grades. For joining and surfacing work on cryogenic matching/similar austenitic CrNi(N) steels/cast steel grades.

**Marks (rods only)**
 W 19 9L / ER308L
**Base materials**

TÜV-certified parent metal 1.4301 – X5CrNi18-10 1.4311 – X2CrNi18-10 1.4550 – X6CrNiNb18-10 AISI 304, 304L, 304LN, 302, 321, 347; ASTM A157 Gr. C9, A320 Gr. B8G or D

**Typical composition of welding rod (Wt-%)**

C	Si	Mn	Cr	Ni			
0,02	0,5	1,7	20,0	10,0			

**Mechanical properties of all-weld metal**

Heat Treatment	Yield strength 0,2%	Tensile strength	Elongation ( $L_0=5d_0$ )	Impact values in J CVN	
	MPa	MPa	%	at room temperature	-196 °C:
untreated	400	570	35	100	35

**Operating data**

Polarity = -

Shielding gas (EN ISO 14175) I1, I3

**Dimensions (mm)**

1,0	1,2	1,6	2,0	2,4	3,2	4,0
-----	-----	-----	-----	-----	-----	-----

**Approvals and certificates**

TÜV (Certificate No. 9451) DB (Reg. form No. 43.132.19) CWB (ER 308L) DNV

# Thermanit JE-308L Si

TIG rod

<b>Classifications</b>	high-alloyed	
EN ISO 14343-A	AWS A5.9	
W 19 9 L Si	ER308LSi	

## Characteristics and field of use

Stainless; resistant to intercrystalline corrosion and wet corrosion up to 350 °C (662 °F). Corrosion-resistant similar to matching low-carbon and stabilized austenitic 18/8 CrNi(N) steels/cast steel grades. Cold toughness at subzero temperatures as low as -196 °C (-321 °F). For joining and surfacing applications with matching and similar – stabilized and non-stabilized – austenitic CrNi(N) and CrNiMo(N) steels/cast steel grades. For joining and surfacing work on cryogenic matching/similar austenitic CrNi(N) steels/cast steel grades.

## Marks (rods only)

front:  W 19 9L Si  
back: ER309LSi

## Base materials

TÜV-certified parent metal  
1.4301 – X5CrNi18-10 1.4311 – X2CrNiN18-10; 1.4550 – X6CrNiNb18-10 AISI 304, 304L, 304LN, 302, 321, 347; ASTM A157 Gr. C9, A320 Gr. B8C or D.

## Typical composition of welding rod (Wt-%)

C	Si	Mn	Cr	Ni	
0,02	0,9	1,7	20,0	10,0	

## Mechanical properties of all-weld metal

Heat Treatment	Yield strength 0,2%	Tensile strength	Elongation ( $L_0=5d_0$ )	Impact values in J CVN	
	MPa	MPa	%	at room temperature	-196 °C
untreated	350	570	35	75	35

## Operating data

	Polarity = +	Shielding gas (EN ISO 14175) M11, M12, M13
---	--------------	--

## Dimensions (mm)

0,8	1,0	1,2	1,6		
-----	-----	-----	-----	--	--

## Approvals and certificates

TÜV (Certificate No. 0555) DB (Reg. form No. 43.132.08) CWB (ER 308L-Si) DNV

**BÖHLER CN 23/12-IG**

TIG rod

**Classifications**

high-alloyed

EN ISO 14343-A:

AWS A5.9:

W 23 12 L

ER309L

**Characteristics and field of use**

TIG welding rod with increased ferrite content (FN ~16) in the weld metal. High crack resistance with hard-to-weld materials, austenite-ferrite joints and weld claddings. Dilution is to be kept as low as possible. Usable for operating temperatures between -120°C and +300°C.

**Marks (rods only)**

front:  W 23 12 L  
back: ER 309 L

**Base materials**

Joints of and between high-strength, unalloyed and alloyed quenched and tempered steels, stainless, ferritic Cr and austenitic Cr-Ni steels, austenitic manganese steels and weld claddings: for the first layer of chemically resistant weld claddings on the ferritic-pearlitic steels used for boiler and pressure vessel construction up to fine-grained structural steel S500N, and for the creep resistant fine-grained structural steels 22NiMoCr4-7, 20MnMoNi5-5 and GS-18NiMoCr3 7.

**Typical composition of welding rod (Wt-%)**

C	Si	Mn	Cr	Ni			
≤0.02	0,5	1,7	23,5	13,2			

**Mechanical properties of all-weld metal**

Heat Treatment	Yield strength	Tensile	Elongation	Impact values	
	0,2%	strength	( $L_0=5d_0$ )	in J CVN	
	MPa	MPa	%	+20°C:	
untreated	440	580	34	150	

**Operating data**

Polarity = -

shielding gas: 100% Argon

**Dimensions (mm)**

1,6

2,0

2,4

3,2

**Approvals and certificates**

TÜV-D (4699), GL (4332), SEPROZ, DB (43.014.29), CE

**Similar alloy filler metals**

SMAW electrode:	FOX CN 23/12-A FOX CN 23/12 Mo-A	Flu cored wire:	CN 23/12-MC CN 23/12-FD CN 23/12 PW-FD CN 23/12 Mo-FD CN 23/12 Mo PW-FD
GMAW solid wire:	CN 23/12-IG		

**Thermanit 25/14 E-309L**

TIG rod

<b>Classifications</b>	high-alloyed	
EN ISO 14343-A	AWS A5.9	
W 23 12 L	ER309L	

**Characteristics and field of use**

Stainless; wet corrosion up to 350 °C (662 °F). Well suited for depositing intermediate layers when welding clad materials. Favourably high Cr- and Ni-contents, low C content. For joining unalloyed/low-alloy steels/cast steel grades or stainless heat resistant Cr-steels/cast steel grades to austenitic steels/cast steel grades. For depositing intermediate layers when welding the side of plates clad with low-carbon – non-stabilized and stabilized – austenitic CrNi(MoN) austenitic metals.

**Marks (rods only)**
 W 23 12 L / ER309L
**Base materials**

TÜV-certified parent metal. Combinations between 1.4583 – X10CrNiMoNb18-12 and ferritic steels up to S355N. Joints of and between high-tensile, unalloyed and alloyed quenched and tempered steels, stainless, ferritic Cr and austenitic Cr-Ni steels, high manganese steels as well as claddings: for the first layer of chemical resistant weld claddings on ferriticpearlitic steels up to fine grained structural steels S500N, in steam boiler and pressure boiler construction, as well as creep resistant fine grained structural steels 11NiMoCr4-7 acc. to leaflet "SEW-Werkstoffblatt" No. 365, 366, 20MnMoNi5-5 and G18NiMoCr3-7.

**Typical composition of welding rod (Wt-%)**

C	Si	Mn	Cr	Ni	
0,02	0,5	1,7	24,0	13,0	

**Mechanical properties of all-weld metal**

Heat Treatment	Yield strength 0,2%	Tensile strength	Elongation ( $L_0=5d_0$ )	Impact values in J CVN
	MPa	MPa	%	at room temperature
untreated	430	580	30	80

**Operating data**

	Polarity = –	Shielding gas (EN ISO 14175) I1
---	--------------	---------------------------------

**Dimensions (mm)**

1,6	2,0	2,4	3,2		
-----	-----	-----	-----	--	--

**Approvals and certificates**

TÜV (Certificate No. 2661) CWB (ER 309L-Si) GL (4332)



# Avesta 309L-Si

TIG rod

## Classifications

high-alloyed

EN ISO 14343-A:

AWS A5.9:

W 23 12 L Si

ER309LSi

## Characteristics and field of use

Avesta 309L-Si is a high-alloy 23 Cr 13 Ni wire primarily intended for surfacing of low-alloy steels and dissimilar welding between mild steels and stainless steels, offering a ductile and crack resistant weldment. The chemical composition, when surfacing, is equivalent to that of ASTM 304 from the first run. One or two layers of 309L are usually combined with a final layer of 308L, 316L or 347.

### Corrosion resistance:

Superior to type 308L. When used for overlay welding on mild steel a corrosion resistance equivalent to that of 1.4301/ASTM 304 is obtained already in the first layer.

## Base materials

For welding steels such as

Outokumpu	EN	ASTM	BS	NF	SS
-----------	----	------	----	----	----

Avesta 309L is primarily used when surfacing unalloyed or low-alloy steels and when joining non-molybdenum-alloyed stainless and carbon steels.

10

## Typical composition of welding rod (Wt-%)

C	Si	Mn	Cr	Ni			
0,015	0,80	1,8	23,5	13,5			

Ferrite 9 FN;WRC-92

## Mechanical properties of all-weld metal

Heat Treatment	Yield strength 0,2%	Tensile strength	Elongation ( $L_0=5d_0$ )	Impact values in J CVN
	MPa	MPa	%	+20°C:
untreated	470	610	28	140

## Operating data

Ar (99.95%) or Ar with an addition of 20 – 30% helium (He) or 1 – 5% hydrogen (H<sub>2</sub>). The addition of helium (He) will increase the energy of the arc. Gas flow rate 4 – 8 l/min.

## Dimensions (mm)

1,2	1,6	2,0	2,4	3,2	
-----	-----	-----	-----	-----	--

# Thermanit D

TIG rod

## Classifications

high-alloyed

EN ISO 14343-A

AWS A5.9

W 22 12 H

ER309 (mod.)

## Characteristics and field of use

Resistant to scaling up to 950 °C (1742 °F). For joining and surfacing applications with matching/similar heat resistant steels/cast steel grades.

## Marks (rods only)



W 22 12 H / 1.4829

## Base materials

1.4828 – X15CrNiSi20-12 AISI 305; ASTM A297HF

## Typical composition of welding rod (Wt-%)

C	Si	Mn	Cr	Ni	
0,11	1,2	1,2	22,0	11,0	

## Mechanical properties of all-weld metal

Heat Treatment	Yield strength 0,2%	Tensile strength	Elongation ( $L_0=5d_0$ )	Impact values in J CVN
	MPa	MPa	%	at room temperature
untreated	420	600	30	85

## Operating data



Polarity = -

Shielding gas (EN ISO 14175) I1

## Dimensions (mm)

1,6	2,0	2,4	3,2		
-----	-----	-----	-----	--	--

## Approvals and certificates

**Classifications**

high-alloyed

EN ISO 14343-A:

AWS A5.9:

W 22 12 H

ER309 (mod.)

**Characteristics and field of use**

TIG welding rod for same-type, heat resistant rolled, forged and cast steels, as well as for heat resistant ferritic Cr-Si-Al steels, such as in annealing shops, hardening shops, steam boiler construction, the petrochemical industry and the ceramic industry. Austenitic weld metal containing about 8% ferrite. Preferred for exposure to oxidising gases. Joints on Cr-Si-Al steels that are exposed to gases containing sulphur must be carried out using BÖHLER FOX FA or BÖHLER FA-IG as a final layer. Resistant to scaling up to +1000°C.

**Marks (rods only)**

front:  W 22 12 H  
back: 1.4829

**Base materials**

austenitic

1.4828 X15CrNiSi20-12, 1.4826 GX40CrNiSi22-10, 1.4833 X12CrNi23-13

ferritic-pearlitic

 1.4713 X10CrAlSi7, 1.4724 X10CrAlSi13, 1.4742 X10CrAlSi18, 1.4710 GX30CrSi7,  
1.4740 GX40CrSi17 AISI 305, ASTM A297HF

**Typical composition of welding rod (Wt-%)**

C	Si	Mn	Cr	Ni			
0,1	1,1	1,6	22,5	11,5			

**Mechanical properties of all-weld metal**

Heat Treatment	Yield strength 0,2%	Tensile strength	Elongation ( $L_0=5d_0$ )	Impact values in J CVN
	MPa	MPa	%	+20°C:
untreated	500	630	32	115

**Operating data**

Polarity = -

shielding gas: 100% Argon

**Dimensions (mm)**

1,6	2,0	2,4			
-----	-----	-----	--	--	--

**Approvals and certificates**

TÜV-A (20), SEPROZ

**Similar alloy filler metals**

SMAW electrode:	FOX FF FOX FF-A	GMAW solid wire:	FF-IG
-----------------	--------------------	------------------	-------

# Avesta 316L/SKR

TIG rod

<b>Classifications</b>	high-alloyed	
EN ISO 14343	AWS A5.9	
W 19 12 3 L	E316L	

## Characteristics and field of use

Avesta 316L/SKR is designed for welding 1.4436/ASTM 316 type stainless steels. It is also suitable for welding steels that are stabilised with titanium or niobium, such as 1.4571/ASTM 316Ti, for service temperatures not exceeding 400°C. For higher temperatures, a niobium stabilised consumable such as Avesta 318-Si/SKNb-Si should be used. Avesta Welding also supplies a 316L type wire with high silicon content (316L-Si/SKR-Si). The higher silicon content (0,85%) improves the fluidity of the melt pool with a minimum of spatter and is therefore recommended if the demands on surface quality are high.

## Marks (rods only)

 W 19 12 3 L / E316L

## Base materials

For welding steels such as					
Outokumpu	EN	ASTM	BS	NF	SS
4436	1.4436	316	316S33	Z7 CND 18-12-03	2343
4432	1.4432	316L	316S13	Z3 CND 17-12-03	2353
4429	1.4429	S31653	316S63	Z3 CND 17-12 Az	2375
4571	1.4571	316Ti	320S31	Z6 CNDT 17-12	2350

## Typical composition of welding rod (Wt-%)

C	Si	Mn	Cr	Ni	Mo
0,02	0,40	1,7	18,5	12,2	2,6

Ferrite 7 FN; WRC-92

## Mechanical properties of all-weld metal

Heat Treatment	Yield strength	Tensile strength	Elongation ( $L_0=5d_0$ )	Impact values in J CVN		
	0,2%			MPa	%	+20°C:
untreated	460	610	33	140	130	70

## Operating data

 Ar (99.95%) or Ar with an addition of 20 – 30% helium (He) or 1 – 5% hydrogen (H<sub>2</sub>). The addition of helium (He) and hydrogen (H<sub>2</sub>) will increase the energy of the arc. Gas flow rate 4 – 8 l/min.

## Dimensions (mm)

1,0	1,2	1,6	2,0	2,4	3,2
-----	-----	-----	-----	-----	-----

# Avesta 316L-Si/SKR-Si

TIG rod

<b>Classifications</b>		high-alloyed	
EN ISO 14343-A:	AWS A5.9:		
W 19 12 3 L Si	ER316LSi		

## Characteristics and field of use

Avesta 316L-Si/SKR-Si is designed for welding austenitic stainless steel type 17 Cr 12 Ni 2.5 Mo or similar. The filler metal is also suitable for welding titanium and niobium stabilised steels such as ASTM 316Ti in cases where the construction is used at temperatures not exceeding 400°C. For higher temperatures a niobium stabilised consumable such as Avesta 318-Si/SKnb-Si is required.

### Corrosion resistance:

Excellent resistance to general, pitting and intergranular corrosion in chloride containing environments. Intended for severe service conditions, e.g. in dilute hot acids.

## Base materials

For welding steels such as					
Outokumpu	EN	ASTM	BS	NF	SS
4436	1.4436	316	316S33	Z7 CND 18-12-03	2343
4432	1.4432	316L	316S13	Z3 CND 17-12-03	2353
4429	1.4429	S31653	316S63	Z3 CND 17-12 Az	2375
4571	1.4571	316Ti	320S31	Z6 CNDT 17-12	2350

## Typical composition of welding rod (Wt-%)

C	Si	Mn	Cr	Ni	Mo		
0,02	0,85	1,7	18,5	12,0	2,6		

Ferrite 6 FN;WRC-92

## Mechanical properties of all-weld metal

Heat Treatment	Yield strength	Tensile strength	Elongation	Impact values
	0,2%		( $L_0=5d_0$ )	in J CVN
	MPa	MPa	%	+20°C:
untreated	450	600	31	140

## Operating data



Ar (99.95%) or Ar with an addition of 20 – 30% helium (He) or 1 – 5% hydrogen (H<sub>2</sub>). The addition of helium (He) and hydrogen (H<sub>2</sub>) will increase the energy of the arc. Gas flow rate 4 – 8 l/min.

## Dimensions (mm)

1,0	1,2	1,6	2,0	2,4	3,2	4,0
-----	-----	-----	-----	-----	-----	-----

**BÖHLER EAS 4 M-IG**

TIG rod

**Classifications**

high-alloyed

EN ISO 14343-A:

AWS A5.9:

W 19 12 3 L

ER316L

**Characteristics and field of use**

TIG welding rod. For application in all branches of industry in which same-type steels, including higher-carbon steels, and ferritic 13% chrome steels are welded, e.g. the construction of chemical apparatus and containers, the chemical, pharmaceutical and cellulose, rayon and textile industries, and many more. Very good welding and flow behaviour. Resists intergranular corrosion up to an operating temperature of +400°C. Cryogenic down to -196°C.

**Marks (rods only)**

front:  W 19 12 3 L  
back: ER 316 L

**Base materials**

1.4401 X5CrNiMo17-12-2, 1.4404 X2CrNiMo17-12-2, 1.4435 X2CrNiMo18-14-3, 1.4436 X3CrNiMo17-13-3, 1.4571 X6CrNiMoTi17-12-2, 1.4580 X6CrNiMoNb17-12-2, 1.4583 X10CrNiMoNb18-12, 1.4409 GX2CrNiMo19-11-2, UNS S31603, S31653; AISI 316L, 316Ti, 316Cb

**Typical composition of welding rod (Wt-%)**

C	Si	Mn	Cr	Ni	Mo		
≤0.02	0,5	1,8	18,5	12,3	2,8		

**Mechanical properties of all-weld metal**

Heat Treatment	Yield strength 0,2%	Tensile strength	Elongation ( $L_0=5d_0$ )	Impact values in J CVN	
	MPa	MPa	%	+20°C:	
untreated	470	610	38	140	

**Operating data**

	Polarity = -	shielding gas: 100% Argon
---	--------------	---------------------------

**Dimensions (mm)**

1,6	2,0	2,4	3,0		
-----	-----	-----	-----	--	--

**Approvals and certificates**

TÜV-D (00149), DB (43.014.12), DNV (316L), GL (4429), SEPPOZ, NAKS (Ø2.4; 3.0), CE

**Similar alloy filler metals**

SMAW electrode:	FOX EAS 4 M FOX EAS 4 M (LF) FOX EAS 4 M-A FOX EAS 4 M-VD	Flu cored wire:	EAS 4 M-MC EAS 4 M-FD EAS 4 PW-FD EAS 4 PW-FD (LF)
	GMAW solid wire:		EAS 4 M-IG (Si)

# Thermanit GE-316L

TIG rod

<b>Classifications</b>		high-alloyed	
EN ISO 14343-A:	AWS A5.9:		
W 19 12 3 L	ER316L		

## Characteristics and field of use

Stainless; resistant to intercrystalline corrosion and wet corrosion up to 400 °C (752 °F). Corrosion-resistance similar to matching low-carbon and stabilized austenitic 18/8 CrNiMo steels/cast steel grades. For joining and surfacing application with matching and similar – non-stabilized and stabilized – austenitic CrNi(N) and CrNiMo(N) steels and cast steel grades.

## Marks (rods only)

 W 19 12 3L / ER316L

## Base materials

TÜV-certified parent metal  
1.4583 – X10CrNiMoNb18-12; S31653, AISI 316L, 316Ti, 316Cb

## Typical composition of welding rod (Wt-%)

C	Si	Mn	Cr	Ni	Mo		
0,02	0,5	1,7	18,5	12,3	2,6		

## Mechanical properties of all-weld metal

Heat Treatment	Yield strength 0,2%	Tensile strength	Elongation ( $L_0=5d_0$ )	Impact values in J CVN
	MPa	MPa	%	+20°C:
untreated	450	580	35	100

## Operating data

	Polarity = –	Shielding gas (EN ISO 14175) I1
---	--------------	---------------------------------

## Dimensions (mm)

1,0	1,2	1,6	2,0	2,4	3,2	4,0
-----	-----	-----	-----	-----	-----	-----

# Thermanit GE-316L Si

TIG rod

Classifications		high-alloyed	
EN ISO 14343-A:	AWS A5.9:		
W 19 12 3 L Si	ER316LSi		

## Characteristics and field of use

Stainless; resistant to intercrystalline corrosion and wet corrosion up to 400 °C (752 °F). Corrosion-resistance similar to matching low-carbon and stabilized austenitic 18/8 CrNiMo steels/cast steel grades. For joining and surfacing application with matching and similar – non-stabilized – austenitic CrNi(N) and CrNiMo(N) steels and cast steel grades.

## Marks (rods only)

front:  W 19 12 3 L  
back: ER 316 L

## Base materials

TÜV-certified parent metal 1.4583 – X10CrNiMoNb18-12; UNS S31653; AISI 316Cb, 316L, 316Ti

## Typical composition of welding rod (Wt-%)

C	Si	Mn	Cr	Ni	Mo		
0.02	0,8	1,7	18,8	12,5	2,8		

## Mechanical properties of all-weld metal

Heat Treatment	Yield strength 0,2%	Tensile strength	Elongation ( $L_0=5d_0$ )	Impact values in J CVN
	MPa	MPa	%	+20°C:
untreated	380	560	35	70

## Operating data

	Polarity = –	Shielding gas (EN ISO 14175) M12, M13
--	--------------	---------------------------------------

## Dimensions (mm)

0,8	1,0	1,2	1,6		
-----	-----	-----	-----	--	--

## Approvals and certificates

TÜV (Certificate No. 0489) DB (Reg. form No. 43.132.10) LR (fitV7R-12) CWB (ER 316L-Si)  
GL (4429S) DNV



**BÖHLER SAS 4-IG**

TIG rod

**Classifications**

high-alloyed

EN ISO 14343-A:

AWS A5.9:

W 19 12 3 Nb

ER318

**Characteristics and field of use**

TIG welding rod. For application in all branches of industry in which same-type steels and ferritic 13% chrome steels are welded, e.g. the construction of chemical apparatus and containers, the textile and cellulose industry, dye works, beverage production, synthetic resin plants and many more. Also suitable for media containing chlorides due to the inclusion of Mo. Very good welding and flow behaviour. Resists intergranular corrosion up to an operating temperature of +400°C.

**Marks (rods only)**

front:  W 19 12 3 Nb  
back: ER 318

**Base materials**

1.4571 X6CrNiMoTi17-12-2, 1.4580 X6CrNiMoNb17-12-2, 1.4401 X5CrNiMo17-12-2,  
1.4581 GX5CrNiMoNb19-11-2, 1.4437 GX6CrNiMo18-12, 1.4583 X10CrNiMoNb18-12,  
1.4436 X3CrNiMo17-13-3 AISI 316L, 316Ti, 316Cb

**Typical composition of welding rod (Wt-%)**

C	Si	Mn	Cr	Ni	Mo	Nb	
0.035	0,45	1,7	19,5	11,4	2,7	+	

**Mechanical properties of all-weld metal**

Heat Treatment	Yield strength 0,2%	Tensile strength	Elongation ( $L_0=5d_0$ )	Impact values in J CVN	
	MPa	MPa	%	+20°C:	120°C:
untreated	520	700	35	120	(≥ 32)

**Operating data**

Polarity = -

shielding gases: 100 % Argon

**Dimensions (mm)**

1,6

2,0

2,4

3,0

**Approvals and certificates**

TÜV-D (00236.), KTA 1408.1 (08046.), DB (43.014.03), GL (4571), SEPROZ,  
NAKS (Ø2.0; 2.4; 3.0), CE

**Similar alloy filler metals**

SMAW electrode:	FOX SAS 4 FOX SAS 4-A	Flu cored wire:	SAS 4-FD SAS 4 PW-FD
GMAW solid wire:	SAS 4-IG (Si)		
SAW combination:	SAS 4-UP /BB 202		

# Thermanit A

TIG rod

Classifications		high-alloyed	
EN ISO 14343-A:	AWS A5.9:		
W 19 12 3 Nb	ER318		

## Characteristics and field of use

Stainless; resistant to intercrystalline corrosion and wet corrosion up to 400 °C (752 °F). Corrosion-resistant similar to matching stabilized CrNiMo steels. For joining and surfacing application with matching and similar – stabilized and non-stabilized – austenitic CrNi(N) and CrNiMo(N) steels and cast steel grades.

## Marks (rods only)



W 19 12 3 Nb / ER318

## Base materials

TÜV-certified parent metal 1.4583 – X10CrNiMoNb18-12; UNS S31653; AISI 316Cb, 316L, 316Ti

## Typical composition of welding rod (Wt-%)

C	Si	Mn	Cr	Ni	Mo	Nb	
0,04	0,4	1,7	19,5	11,5	2,7	≥12xC	

## Mechanical properties of all-weld metal

Heat Treatment	Yield strength 0,2%	Tensile strength	Elongation ( $L_0=5d_0$ )	Impact values in J CVN
	MPa	MPa	%	+20°C:
untreated	400	600	30	100

## Operating data



Polarity = -

Shielding gas (EN ISO 14175) I1

## Dimensions (mm)

1,0	1,6	2,0	2,4	3,2	4,0	5,0
-----	-----	-----	-----	-----	-----	-----

## Approvals and certificates

TÜV (Certificate No. 9474), DB (Reg. form No. 43.132.27)

# Avesta 318-Si/SKNb-Si

TIG rod

## Classifications

high-alloyed

EN ISO 14343-A:

AWS A5.9:

W 19 12 3 Nb Si

ER318 (mod.)

## Characteristics and field of use

Avesta 318-Si/SKNb-Si is designed for welding steels that are stabilised with titanium or niobium such as 1.4571/ASTM 316Ti and similar, providing improved high temperature properties, e.g. creep resistance, compared to low-carbon non-stabilised materials. 318-Si/SKNb-Si shows better properties than 316L-Si/SKR-Si at elevated temperatures and is therefore recommended for applications with service temperatures above 400°C. A stabilised weldment has improved high temperature properties, e.g. creep resistance, compared to low-carbon non-stabilised grades.

### Corrosion resistance:

Corresponding to 1.4571/ASTM 316Ti, i.e. good resistance to general, pitting and intergranular corrosion.

## Base materials

For welding steels such as

Outokumpu	EN	ASTM	BS	NF	SS
4571	1.4571	316Ti	320S31	Z6 CNDT 17-12	2350

## Typical composition of welding rod (Wt-%)

C	Si	Mn	Cr	Ni	Mo	Nb	
0,04	0,85	1,3	19,0	12,0	2,6	>12xC	

7 FN; WRC- 92

## Mechanical properties of all-weld metal

Heat Treatment	Yield strength 0,2%	Tensile strength	Elongation ( $L_0=5d_0$ )	Impact values in J CVN	
	MPa	MPa	%	+20°C:	-40°C:
untreated	520	690	31	110	60

## Operating data



Ar (99.95%) or Ar with an addition of 20 – 30% helium (He) or 1 – 5% hydrogen (H<sub>2</sub>). The addition of helium (He) and hydrogen (H<sub>2</sub>) will increase the energy of the arc. Gas flow rate 4 – 8 l/min.

## Dimensions (mm)

1,6	2,0	2,4	3,2			
-----	-----	-----	-----	--	--	--

# BÖHLER SAS 2-IG

TIG rod

Classifications		high-alloyed	
EN ISO 14343-A:	AWS A5.9:		
W 19 9 Nb	ER347		

## Characteristics and field of use

TIG welding rod. For application in all branches of industry in which same-type steels and ferritic 13% chrome steels are welded, e.g. the construction of chemical apparatus and containers, the textile and cellulose industry, dye works and many more. Very good welding and flow behaviour. Resists intergranular corrosion up to an operating temperature of +400°C. Cryogenic down to -196°C.

## Marks (rods only)

front:  W 19 9 Nb  
back: ER 347

## Base materials

1.4550 X6CrNiNb18-10, 1.4541 X6CrNiTi18-10, 1.4552 GX5CrNiNb19-11, 1.4301 X5CrNi18-10, 1.4312 GX10CrNi18-8, 1.4546 X5CrNiNb18-10, 1.4311 X2CrNi18-10, 1.4306 X2CrNi19-11  
AISI 347, 321,302, 304, 304L, 304LN, ASTM A296 Gr. CF 8 C, A157 Gr. C9, A320 Gr. B8C or D

## Typical composition of welding rod (Wt-%)

C	Si	Mn	Cr	Ni	Nb		
0,05	0,5	1,8	19,6	9,5	+		

## Mechanical properties of all-weld metal

Heat Treatment	Yield strength	Tensile strength	Elongation	Impact values	
	0,2%		( $L_0=5d_0$ )	in J CVN	
	MPa	MPa	%	+20°C:	-120°C:
untreated	490	660	35	140	(≥ 32)

## Operating data



Polarity = -

shielding gases: 100 % Argon

## Dimensions (mm)

1,6	2,0	2,4	3,0		
-----	-----	-----	-----	--	--

## Approvals and certificates

TÜV-D (00142.), GL (4550), LTSS, SEPROZ, NAKS, CE

## Similar alloy filler metals

SMAW electrode:	FOX SAS 2 FOX SAS 2-A	Flu cored wire:	SAS 2-FD SAS 2 PW-FD
GMAW solid wire:	SAS 2-IG (Si)	SAW combination:	SAS 2-UP/BB 202

**Thermanit H-347**

TIG rod

**Classifications**

high-alloyed

EN ISO 14343-A:

AWS A5.9:

W 19 9 Nb

ER347

**Characteristics and field of use**

Stainless; resistant to intercrystalline corrosion and wet corrosion up to 400 °C (752 °F). Corrosion-resistant similar to matching stabilized austenitic CrNi steels/cast steel grades. For joining and surfacing application with matching and similar – stabilized and non-stabilized – austenitic CrNi(N) steels and cast steel grades.

**Marks (rods only)**
 W 19 9 Nb / ER347
**Base materials**

TÜV-certified parent metal 1.4550 – X6CrNiNb18-10 and the parent metals also covered by VdTÜV-Merkblatt 1000. AISI 347, 321, 302, 304, 304L, 304LN ASTM A296 Gr. CF8, A157 Gr. C9; A320 Gr. B8C or D

**Typical composition of welding rod (Wt-%)**

C	Si	Mn	Cr	Ni	Nb		
0,05	0,5	1,8	19,5	9,5	≥12xC		

**Mechanical properties of all-weld metal**

Heat Treatment	Yield strength 0,2%	Tensile strength	Elongation ( $L_0=5d_0$ )	Impact values in J CVN
	MPa	MPa	%	at room temperature
untreated	400	570	30	65

**Operating data**

Polarity = -

Shielding gas (EN ISO 14175) I1

**Dimensions (mm)**

1,0	1,6	2,0	2,4	3,2		
-----	-----	-----	-----	-----	--	--

**Approvals and certificates**

TÜV (Certificate No. 9475) DB (Reg. form No. 43.132.21)

<b>Classifications</b>		high-alloyed	
EN ISO 14343-A:	AWS A5.9:		
W 13 4	ER410NiMo (mod.)		

### Characteristics and field of use

TIG welding rod for same-type corrosion-resistant, martensitic and martensitic-ferritic rolled, forged and cast steels. Used in the construction of water turbines and compressors, and in the construction of steam power stations. Resistant to water and steam. Very good welding and flow behaviour.

### Marks (rods only)

front:  W 13 4  
back: -

### Base materials

1.4317 GX4CrNi13-4, 1.4313 X3CrNiMo13-4, 1.4407 GX5CrNiMo13-4, 1.4414 GX4CrNiMo13-4  
ACI Gr. CA6NM

### Typical composition of welding rod (Wt-%)

C	Si	Mn	Cr	Ni	Mo		
0,01	0,7	0,7	12,3	4,7	0,5		

### Mechanical properties of all-weld metal

Heat Treatment	Yield strength	Tensile strength	Elongation	Impact values	
	0,2%		( $L_0=5d_0$ )	in J CVN	
	MPa	MPa	%	+20°C:	
untreated	915	1000	15	85	

### Operating data

	Polarity = -	shielding gases: 100 % Argon
--	--------------	------------------------------

### Dimensions (mm)

2,0	2,4			
-----	-----	--	--	--

### Approvals and certificates

TÜV-D (04110.), SEPROZ, CE

### Similar alloy filler metals

SMAW electrode:	FOX CN 13/4 FOX CN 13/4 SUPRA	Flu cored wire:	CN 13/4-MC CN 13/4-MC (F)
GMAW solid wire:	CN 13/4-IG	SAW combination:	CN 13/4-UP/BB 203

# Avesta 2205

TIG rod

## Classifications

high-alloyed

EN ISO 14343 AWS A5.9

W 22 9 3 N L ER2209

## Characteristics and field of use

Avesta 2205 is primarily designed for welding the duplex grade Outokumpu 2205 and similar grades but can also be used for welding SAF 2304 type of steels.

Avesta 2205 provides a ferritic-austenitic weldment that combines many of the good properties of both ferritic and austenitic stainless steels. Welding without filler metal (TIG dressing) is not allowed since the ferrite content will increase drastically which will have a negative effect on both mechanical and corrosion properties. The weldability of duplex steels is excellent but the welding should be adapted to the base material, considering fluidity, joint design, heat input etc.

### Corrosion resistance:

Very good resistance to pitting and stress corrosion cracking in chloride containing environments. PREN>35. Meets the corrosion test requirements per ASTM G48 Methods A, B and E (22°C), ASTM G36 and NACE TM 0177 Method A.

## Base materials

For welding steels such as

Outokumpu	EN	ASTM	BS	NF	SS
2205	1.4462	S32205	318S13	Z3 CND 22-05 Az	2377

## Typical composition of welding rod (Wt-%)

C	Si	Mn	Cr	Ni	Mo	N
0,02	0,5	1,6	22,8	8,5	3,1	0,17

Ferrite 50 FN; WRC-92

## Mechanical properties of all-weld metal

Heat Treatment	Yield strength 0,2%	Tensile strength	Elongation ( $L_0=5d_0$ )	Impact values in J CVN	
	MPa	MPa	%	+20°C:	-40°C:
untreated	560	720	26	200	170

## Operating data



Ar (99.95%). An addition of up to 2% nitrogen (N<sub>2</sub>) and 20 – 30% helium (He) is advantageous and will have a positive effect on both mechanical and corrosion properties. The addition of helium (He) will increase the energy of the arc. Gas flow rate 4 – 8 l/min.

## Dimensions (mm)

1,2	1,6	2,0	2,4	3,2		
-----	-----	-----	-----	-----	--	--

**BÖHLER CN 22/9 N-IG**

TIG rod

**Classifications**

high-alloyed

EN ISO 14343-A:

AWS A5.9:

W 22 9 3 N L

ER2209

**Characteristics and field of use**

TIG welding rod ideally suited to welding ferritic-austenitic duplex steels. As a result of the carefully adjusted alloy, the weld metal not only features high strength and toughness, but is also exceptionally resistant to stress corrosion cracking and to pitting (ASTM G48 / Method A). The welding consumable can be used in a temperature range from -60°C up to +250°C. To achieve the special properties of the weld metal, it is necessary to ensure controlled dilution and thorough back purging. In particularly demanding cases, small proportions of N<sub>2</sub> may be added to the shielding gas and/or the purging gas. The TIG rod features very good welding and flow behaviour.

**Marks (rods only)**

front:  W 22 9 3 NL  
back: ER 2209

**Base materials**

same-type duplex steels as well as similar-alloy, ferritic-austenitic materials of increased strength 1.4462 X2CrNiMoN22-5-3, 1.4362 X2CrNiN23-4, 1.4462 X2CrNiMoN22-5-3 with 1.4583 X10CrNi-MoNb18-12, 1.4462 X2CrNiMoN22-5-3 with P235GH/P265GH, S255N, P295GH, S355N, 16Mo3 UNS S31803, S32205

**Typical composition of welding rod (Wt-%)**

C	Si	Mn	Cr	Ni	Mo	N	PRE <sub>N</sub>
≤0.015	0,4	1,7	22,5	8,8	3,2	0,15	≥35

**Mechanical properties of all-weld metal**

Heat Treatment	Yield strength	Tensile strength	Elongation	Impact values	
	0,2%		(L <sub>0</sub> =5d <sub>0</sub> )	in J CVN	
	MPa	MPa	%	+20°C:	-60°C:
untreated	600	800	33	150	(≥ 32)

**Operating data**

	Polarity = -	shielding gases: 100 % Argon
--	--------------	------------------------------

**Dimensions (mm)**

2,0	2,4			
-----	-----	--	--	--

**Approvals and certificates**

TÜV-D (04484.), ABS (ER2209), DNV (X (I1)), GL (4462), LR (X), Statoil, CE

**Similar alloy filler metals**

SMAW electrode:	FOX CN 22/9 N-B FOX CN 22/9 N	Flu cored wire:	CN 22/9 N-FD CN 22/9 PW-FD
GMAW solid wire:	CN 22/9 N-IG	SAW combination:	CN 22/9 N-UP/BB202

25



**Thermanit 22/09**

TIG rod

**Classifications**

high-alloyed

EN ISO 14343-A:

AWS A5.9:

W 22 9 3 NL

ER2209

**Characteristics and field of use**

Duplex stainless steel; resistant to intercrystalline corrosion and wet corrosion up to 250 °C (482 °F). Good resistance to stress corrosion cracking in chlorine- and hydrogen sulphide-bearing environment. High Cr- and Mo-contents provide resistance to pitting corrosion. For joining and surfacing work with matching and similar austenitic steels/cast steel grades. Attention must be paid to embrittlement susceptibility of the parent metal.

**Marks (rods only)**

W 22 9 3 NL / ER2209

**Base materials**

TÜV-certified duplex stainless steels 1.4462 – X2CrNiMoN22-5-3 and others, combinations of mentioned steels and ferritic steels up to S355J, 16Mo3 and 1.4583 – X10CrNiMoNb18-12

**Typical composition of welding rod (Wt-%)**

C	Si	Mn	Cr	Mo	Ni	N
0,02	0,4	1,7	22,5	3,2	8,8	0,15

**Mechanical properties of all-weld metal**

Heat Treatment	Yield strength 0,2%	Tensile strength	Elongation ( $L_0=5d_0$ )	Impact values in J CVN
	MPa	MPa	%	at room temperature
untreated	600	720	25	100

**Operating data**

Polarity = -

Shielding gas (EN ISO 14175) I1

**Dimensions (mm)**

1,6	2,0	2,4	3,2		
-----	-----	-----	-----	--	--

**Approvals and certificates**

TÜV (Certificate No. 3343) GL (4462) ABS DNV LR

# Avesta LDX 2101

TIG rod

## Classifications

high-alloyed

EN ISO 14343

W 23 7 N L

## Characteristics and field of use

Avesta LDX 2101 is designed for welding the duplex stainless steel Outokumpu LDX 2101, a „lean duplex“ steel with excellent strength and medium corrosion resistance. The steel is mainly intended for applications such as civil engineering, storage tanks, containers etc. Avesta LDX 2101 is over alloyed with respect to nickel to ensure the right ferrite balance in the weld metal. Welding can be performed using short, spray or pulsed arc. Welding using pulsed arc provides good results in both horizontal and vertical-up positions. Pulsed arc and 1.20 mm wire will give the best flexibility. The weldability of duplex steels is excellent but the welding should be adapted to the base material, considering fluidity, joint design, heat input etc.

### Corrosion resistance:

Good resistance to general corrosion. Better resistance to pitting, crevice corrosion and stress corrosion cracking than 1.4301/AISI 304.

## Base materials

For welding steels such as

Outokumpu	EN	ASTM	BS	NF	SS
LDX 2101®	1.4162	S32101	-	-	-

## Typical composition of welding rod (Wt-%)

C	Si	Mn	Cr	Ni	Mo	N
0,02	0,5	0,8	23,0	7,5	0.5	0,14

Ferrite 45 FN; WRC -92

## Mechanical properties of all-weld metal

Heat Treatment	Yield strength 0,2%	Tensile strength	Elongation ( $L_0=5d_0$ )	Impact values in J CVN	
	MPa	MPa	%	+20°C:	-40°C:
untreated	600	750	34	180	180

## Operating data



Ar (99.95%). An addition of up to 2% nitrogen (N<sub>2</sub>) and 20 – 30% helium (He) is advantageous and will have a positive effect on both mechanical and corrosion properties. The addition of helium (He) will increase the energy of the arc. Gas flow rate 4 – 8 l/min.

## Dimensions (mm)

1,2	1,6	2,4	3,2		
-----	-----	-----	-----	--	--

<b>Classifications</b>		high-alloyed	
EN ISO 14343	AWS A5.9		
W 23 12 2 L	(ER309LMo)*	*Cr lower and Ni higher than standard.	

#### Characteristics and field of use

Avesta P5 is a high-alloy low carbon wire of the 309LMo type, primarily designed for surfacing low-alloy steels and for welding dissimilar joints between stainless and mild or low-alloy steels. It is also suitable for welding steels like durostat® and alform®. When used for surfacing, a composition equivalent to that of 1.4401/ASTM 316 is obtained already in the first layer.

#### Corrosion resistance:

Superior to type 316L. When used for overlay welding on mild steel a corrosion resistance equivalent to that of 1.4401/ASTM 316 is obtained already in the first layer.

#### Base materials

For welding steels such as

Outokumpu	EN	ASTM	BS	NF	SS
-----------	----	------	----	----	----

Avesta P5 is primarily used when surfacing unalloyed or low-alloy steels and when joining molybdenum-alloyed stainless and carbon steels.

#### Typical composition of welding rod (Wt-%)

C	Si	Mn	Cr	Ni	Mo		
0,02	0,35	1,5	21,5	15,0	2,7		

Ferrite 8 FN; WRC-92

#### Mechanical properties of all-weld metal

Heat Treatment	Yield strength 0,2%	Tensile strength	Elongation ( $L_0=5d_0$ )	Impact values in J CVN	
	MPa	MPa	%	+20°C:	-40°C:
untreated	470	640	30	110	90

#### Operating data



Ar (99.95%) or Ar with an addition of 20 – 30% helium (He) or 1 – 5% hydrogen (H<sub>2</sub>). The addition of helium (He) will increase the energy of the arc. Gas flow rate 4 – 8 l/min.

#### Dimensions (mm)

1,2	1,6	2,0	2,4	3,2		
-----	-----	-----	-----	-----	--	--

# Avesta 2507/P100

TIG rod

## Classifications

high-alloyed

EN ISO 14343      AWS A5.9

W 25 9 4 N L      ER2594

## Characteristics and field of use

Avesta 2507/P100 is intended for welding super duplex alloys such as 2507, ASTM S32760, S32550 and S31260. It can also be used for welding duplex type 2205 if extra high corrosion resistance is required, e.g. in root runs in tubes. Welding without filler metal (TIG dressing) is not allowed since the ferrite content will increase drastically which will have a negative effect on both mechanical and corrosion properties. The weldability of duplex and super duplex steels is excellent but the welding should be adapted to the base material, considering fluidity, joint design, heat input etc.

### Corrosion resistance:

Very good resistance to pitting and stress corrosion cracking in chloride containing environments. PREN>41.5. Meets the corrosion test requirements per ASTM G48 Methods A, B and E (40°C).

## Base materials

For welding steels such as

Outokumpu	EN	ASTM	BS	NF	SS
2507	1.4410	S32750	-	Z3 CND 25-06 Az	2328

## Typical composition of welding rod (Wt-%)

C	Si	Mn	Cr	Ni	Mo	N
0,015	0,35	0,4	25,0	9,5	3,9	0,25

Ferrite 50 FN; WRC-92

## Mechanical properties of all-weld metal

Heat Treatment	Yield strength 0,2%	Tensile strength	Elongation ( $L_0=5d_0$ )	Impact values in J CVN	
	MPa	MPa	%	+20°C:	-50°C:
untreated	680	860	28	170	160

## Operating data



Ar (99.95%). An addition of up to 2% nitrogen (N2) and 20 – 30% helium (He) is advantageous and will have a positive effect on both mechanical and corrosion properties. The addition of helium (He) will increase the energy of the arc. Gas flow rate 4 – 8 l/min.

## Dimensions (mm)

1,2	1,6	2,0	2,4	3,2		
-----	-----	-----	-----	-----	--	--

**BÖHLER CN 25/9 CuT-IG**

TIG rod

**Classifications**

high-alloyed

EN ISO 14343-A:

AWS A5.9:

W 25 9 4 N L

ER2594

**Characteristics and field of use**

TIG welding rod for welding ferritic-austenitic superduplex materials, particularly for offshore engineering. In addition to high strength and good toughness properties, the weld metal is very resistant to pitting and to stress corrosion cracking.  
For operating temperatures between -60°C and +250°C.

**Marks (rods only)**front:  W 25 9 4 NL**Base materials**

25% Cr-superduplex steels e.g.: 1.4501 X2CrNiMoCuWN25-7-4  
UNS S 32750, S 32760 ZERON 100, SAF 25/07, FALC 100

**Typical composition of welding rod (Wt-%)**

C	Si	Mn	Cr	Ni	Mo	N	Cu	W	PRE <sub>N</sub>
0.02	0,3	0,7	25,2	9,2	3,6	0,22	0,6	0,62	≥40

**Mechanical properties of all-weld metal**

Heat Treatment	Yield strength 0,2%	Tensile strength	Elongation (L <sub>0</sub> =5d <sub>0</sub> )	Impact values in J CVN		
	MPa	MPa	%	+20°C:	-50°C:	-60°C:
untreated	620	760	27	200	160	150

**Operating data**

Polarity = -

shielding gases: Argon + 2-3% N<sub>2</sub>  
100% Argon

**Dimensions (mm)**

2,0

2,4

**Similar alloy filler metals**

Flu cored wire:

CN 25/9 PW-FD

SMAW electrode:

FOX CN 25/9 CuT

GMAW solid wire:

CN 25/9 CuT-IG

# Thermanit 25/09 CuT

TIG rod

<b>Classifications</b>		high-alloyed	
EN ISO 14343-A:	AWS A5.9:		
W 25 9 4 NL	ER2594		

## Characteristics and field of use

Super duplex stainless steel; resistant to intercrystalline corrosion (Service temperature: -50 °C up to +220 °C). Very good resistance to pitting corrosion and stress corrosion cracking due to the high CrMo(N) content (pitting index  $\geq 40$ ). Well suited for conditions in offshore application, particularly for welding of supermartensitic stainless steels (13 % Cr); extra low hydrogen in the filler material available on request.

## Marks (rods only)

 W 25 9 4 NL / ER2594

## Base materials

1.4515 – GX3CrNiMoCuN26-6-3 1.4517 – GX3CrNiMoCuN25-6-3-3 25 % Cr-superduplex steels such as Zeron 100, SAF 25/07, FALC 100

## Typical composition of welding rod (Wt-%)

C	Si	Mn	Cr	Mo	Ni	N	Cu	W
0,02	0,3	0,8	25,3	3,7	9,5	0,22	0.6	0.6

## Mechanical properties of all-weld metal

Heat Treatment	Yield strength 0,2%	Tensile strength	Elongation ( $L_0=5d_0$ )	Impact values in J CVN	
	MPa	MPa	%	at room temperature	-40 °C
untreated	600	750	25	80	50

## Operating data



Polarity = -

Shielding gas (EN ISO 14175) I1

## Dimensions (mm)

1,6	2,0	2,4	3,2			
-----	-----	-----	-----	--	--	--

**Thermanit L**

TIG rod

**Classifications**

high-alloyed

EN ISO 14343-A:

W 25 4

**Characteristics and field of use**

Stainless; corrosion-resistant similar to matching or similar Mo-free 25% Cr(Ni) steels/cast steel grades. Should parent metal be susceptible to embrittlement interpass temperature must not be allowed to rise above 300°C (572°F). Resistant to scaling in air and oxidizing combustion gases up to 1150°C (2102°F). Good resistance in sulphurous combustion gases at elevated temperatures. For matching and similar heat resistant steels/cast steel grades.

**Typical composition of welding rod (Wt-%)**

C	Si	Mn	Cr	Ni			
0,06	0,8	0,8	26,0	5,0			

**Mechanical properties of all-weld metal**

Heat Treatment	Yield strength 0,2%	Tensile strength	Elongation ( $L_0=5d_0$ )	Impact values in J CVN
	MPa	MPa	%	
untreated	500	650	20	

**Operating data**

Polarity = +

shielding gas (EN ISO 14175) I1

**Dimensions (mm)**

2,4

## Classifications

high-alloyed

EN ISO 14343-A:

W 25 4

## Characteristics and field of use

TIG welding rod for gas shielded arc welding of heat resistant same type or similar type steels. Ferritic-austenitic weld metal. Due to the low Ni content it is particularly recommended when there will be exposure to oxidising or reducing combustion gases containing sulphur. Resistant to scaling up to +1100°C.

## Marks (rods only)

front:  W 25 4  
back: 1.4820

## Base materials

ferritic-austenitic

1.4821 X15CrNiSi25-4, 1.4823 GX40CrNiSi27-4

ferritic-pearlitic 1.4713 X10CrAlSi7, 1.4724 X10CrAlSi13, 1.4742 X10CrAlSi18, 1.4762 X10CrAlSi25, 1.4710 GX30CrSi7, 1.4740 GX40CrSi17 AISI 327, ASTM A297HC

## Typical composition of welding rod (Wt-%)

C	Si	Mn	Cr	Ni			
0,07	0,8	1,2	25,7	4,5			

## Mechanical properties of all-weld metal

Heat Treatment	Yield strength 0,2%	Tensile strength	Elongation ( $L_0=5d_0$ )	Impact values in J CVN
	MPa	MPa	%	+20°C:
untreated	540	710	22	70

## Operating data

	Polarity = -	shielding gas: 100% Argon
---	--------------	---------------------------

## Dimensions (mm)

2,4					
-----	--	--	--	--	--

## Approvals and certificates

## Similar alloy filler metals

SMAW electrode:	FOX FA	GMAW solid wire:	FA-IG
-----------------	--------	------------------	-------



## Classifications

high-alloyed

EN ISO 14343-A:

AWS A5.9:

W 25 20 Mn

ER310 (mod.)

## Characteristics and field of use

TIG welding rod for same-type, heat resistant rolled, forged and cast steels such as in annealing shops, hardening shops, steam boiler construction, the petrochemical industry and the ceramic industry. Fully austenitic weld metal. Preferred for exposure to gases that are oxidising, contain nitrogen or are low in oxygen. Joint welding on heat resistant Cr-Si-Al steels that are exposed to gases containing sulphur must be carried out using BÖHLER FOX FA or BÖHLER FA-IG as a final layer. Resistant to scaling up to +1200°C. Cryogenic down to -196°C. Due to the risk of embrittlement, the temperature range between +650-900°C should be avoided.

## Marks (rods only)

front:  W 25 20 Mn  
back: 1.4842

## Base materials

austenitic

1.4841 X15CrNiSi25-21, 1.4845 X8CrNi25-21, 1.4828 X15CrNiSi20-12,

1.4840 GX15CrNi25-20, 1.4846 X40CrNi25-21, 1.4826 GX40CrNiSi22-10

ferritic-pearlitic

1.4713 X10CrAlSi7, 1.4724 X10CrAlSi13, 1.4742 X10CrAlSi18, 1.4762 X10CrAlSi25,

1.4710 GX30CrSi7, 1.4740 GX40CrSi7

AISI 305, 310, 314, ASTM A297 HF, A297 HJ

## Typical composition of welding rod (Wt-%)

C	Si	Mn	Cr	Ni		
0,13	0,9	3,2	24,6	20,5		

## Mechanical properties of all-weld metal

Heat Treatment	Yield strength 0,2%	Tensile strength	Elongation ( $L_0=5d_0$ )	Impact values in J CVN	
	MPa	MPa	%	+20°C:	-196°C:
untreated	420	630	33	85	(≥ 32)

## Operating data



Polarity = -

shielding gas: 100% Argon

## Dimensions (mm)

1,6	2,0	2,4			
-----	-----	-----	--	--	--

## Approvals and certificates

SEPROZ

## Similar alloy filler metals

SMAW electrode	FOX FFB FOX FFB-A	GMAW solid wire:	FFB-IG
----------------	----------------------	------------------	--------

## Classifications

high-alloyed

EN ISO 14343-A:

WZ 21 33 Mn Nb

## Characteristics and field of use

UTP A 2133 Mn is suitable for joining and surfacing heat resistant base materials of identical and of similar nature, such as

1.4859	G X 10 NiCrNb 32 20	UNS N08800
1.4876	X 10 NiCrAlTi 32 21	UNS N08810
1.4958	X 5 NiCrAlTi 31 20	UNS N08811
1.4959	X 8 NiCrAlTi 31 21	

A typical application is the root welding of centrifugally cast pipes in the petrochemical industry for operation temperatures up to 1050° C in dependence with the atmosphere.

## Welding characteristics and special properties of the weld metal

Scale resistant up to 1050°C. Good resistance to carburising atmosphere.

## Welding instruction

Clean the weld area thoroughly. Low heat input. Max. interpass temperature 150°C.

## Typical composition of welding rod (Wt-%)

C	Si	Mn	Cr	Ni	Nb	Fe
0.12	0,3	4,5	21,0	33,0	1,2	balance

## Mechanical properties of all-weld metal

Heat Treatment	Yield strength	Tensile strength	Elongation	Impact values
	0,2%		(L <sub>0</sub> =5d <sub>0</sub> )	in J CVN
	MPa	MPa	%	at room temperature
untreated	400	600	20	70

## Operating data



Polarity = -

shielding gas: I1

## Dimensions (mm)

2,0	2,4	3,2
-----	-----	-----

## Approvals and certificates

TÜV (No. 10451)

# UTP A 2535 Nb

TIG rod

## Classifications

high-alloyed

EN ISO 14343-A:

WZ 25 35 Zr

## Characteristics and field of use

UTP A 2535 Nb is suitable for joinings and building up on identical and similar high heat resistant CrNi cast steel (centrifugal- and mould cast parts), such as

1.4852	G-X 40 NiCrSiNb 35 25
1.4857	G-X 40 NiCrSi 35 25

A typical application is the root welding of centrifugally cast pipes in the petrochemical industry for operation temperatures up to 1050° C in dependence with the atmosphere.

## Welding characteristics and special properties of the weld metal

The weld deposit is applicable in a low sulphur, carbon enriching atmosphere up to 1150° C, such as reformer ovens in petrochemical installations.

## Welding instruction

Clean welding area carefully. No pre heating or post weld heat treatment. Keep heat input as low as possible and interpass temperature at max. 150° C.

## Typical composition of welding rod (Wt-%)

C	Si	Mn	Cr	Ni	Nb	Ti	Zr	Fe
0,4	1,0	1,7	25,5	35,5	1,2	+	+	balance

## Mechanical properties of all-weld metal

Heat Treatment	Yield strength 0,2%	Tensile strength	Elongation ( $L_0=5d_0$ )	Impact values in J CVN
	MPa	MPa	%	
untreated	480	600	8	

## Operating data



Polarity = -

shielding gas: I1

## Dimensions (mm)

2,0	2,4	3,2			
-----	-----	-----	--	--	--

# UTP A 3545 Nb

TIG rod

## Classifications

high-alloyed

EN ISO 14343-A:

WZ 35 45 Nb

## Characteristics and field of use

UTP A 3545 Nb is suitable for joining and surfacing on identical and similar high heat resistant cast alloys (centrifugal- and mould cast parts), such as G X-45NiCrNbSiTi 45 35.

The main application field is for tubes and cast parts of reformer and pyrolysis ovens at temperatures up to 1175° C / air.

### Welding characteristics and special properties of the weld metal

The weld deposit is applicable in a low sulphur, carbon enriching atmosphere up to 1175° C and has an excellent creep strength and a good resistance against carburization and oxidation.

### Welding instruction

Clean welding area carefully. No pre-heating or post weld heat treatment. Keep heat input as low as possible and interpass temperature at max. 150° C.

## Typical composition of welding rod (Wt-%)

C	Si	Mn	Cr	Ni	Nb	Ti	Zr	Fe
0,45	1,5	0,8	35,0	45,0	1,0	0,1	0,05	balance

## Mechanical properties of all-weld metal

Heat Treatment	Yield strength 0,2%	Tensile strength	Elongation ( $L_0=5d_0$ )	Impact values in J CVN
	MPa	MPa	%	
untreated	450	650	8	

## Operating data



Polarity = –

shielding gas: I1

## Dimensions (mm)

2,0	2,4	3,2			
-----	-----	-----	--	--	--

# Thermanit 35/45 Nb

TIG rod

## Classifications

EN ISO 18274

S Ni Z (NiCr36Fe15Nb0,8)

## Characteristics and field of use

Resistant to scaling up to 1180 °C (2156 °F). For joining and surfacing work on matching/similar heat resistant cast steel grades

## Marks (rods only)

 35 45 Nb / Ni 6701 mod.

## Base materials

GX45NiCrNbSiTi45-35

## Typical composition of welding rod (Wt-%)

C	Si	Mn	Cr	Ni	Nb		
0,42	1,5	1,0	35,0	45,5	0,8		

## Mechanical properties of all-weld metal

Heat Treatment	Yield strength 0,2%	Tensile strength	Elongation ( $L_0=5d_0$ )	Impact values in J CVN	
	MPa	MPa	%	at room temperature	
AW	450	450			

## Operating data



Polarity = -

Shielding gas (EN ISO 14175) I1

## Dimensions (mm)

2,0	2,4	3,2				
-----	-----	-----	--	--	--	--

## Classifications

EN ISO 18274 AWS A5.14

S NiCr22Mo9Nb ERNiCrMo-3

## Characteristics and field of use

Avesta P12 is a nickel base alloy designed for welding 6Mo-steels such as Outokumpu 254 SMO. It is also suitable for welding nickel base alloys type 625 and 825 and for dissimilar welds between stainless or nickel base alloys and mild steel. To minimise the risk of hot cracking when welding fully austenitic steels and nickel base alloys, heat input and interpass temperature must be low and there must be as little dilution as possible from the parent metal.

**Corrosion resistance:**

Excellent resistance to general corrosion in various types of acids and to pitting, crevice corrosion and stress corrosion cracking in chloride containing environments.

Meets the corrosion test requirements per ASTM G48 Methods A, B and E (50°C).

## Base materials

For welding steels such as

Outokumpu	EN	ASTM	BS	NF	SS
254 SMO®	1.4547	S31254			2378
20-25-6	1.4529	N08926			

Also for welding stainless steels and nickel base alloys to low-alloy and mild steel.

## Typical composition of welding rod (Wt-%)

C	Si	Mn	Cr	Ni	Mo	Nb	Fe
0,01	0,2	0,1	22,0	Bal.	9,0	3,6	< 1,0

Ferrite 0 FN

## Mechanical properties of all-weld metal

Heat Treatment	Yield strength	Tensile strength	Elongation	Impact values		
	0,2%		( $L_0=5d_0$ )	in J CVN		
	MPa	MPa	%	+20°C:	-40°C:	-196°C
with Flux 805	490	740	35	130	120	110

## Operating data



Shielding gas: Ar (99,95%),  
Gas flow rate 4 - 8l/min.

## Dimensions (mm)

1,2	1,6	2,0	2,4	3,2		
-----	-----	-----	-----	-----	--	--

## Classifications

EN ISO 18274: AWS A5.9:

S Ni 6625 (NiCr22Mo9Nb) ERNiCrMo-3

## Characteristics and field of use

TIG welding rod for high quality welded joints to nickel-based alloys with a high Mo content (e.g. Alloy 625 and Alloy 825) and also to CrNiMo steels with a high Mo content (e.g. „6% Mo“ steels). This type is also suitable for creep resistant and highly creep resistant steels, heat resistant and cryogenic materials, dissimilar joints and low-alloy, hard-to-weld steels. Suitable for pressure vessel construction for -196°C to +550°C, otherwise with scaling resistance up to +1200°C (sulphur-free atmosphere). Because of the embrittlement of the base material between 600 and 850°C, use in this temperature range should be avoided. High resistance to hot cracking, in addition to which the C-diffusion at high temperatures or during heat treatment of dissimilar joints is largely inhibited. Extremely high resistance to stress corrosion cracking and pitting (PREN 52). Resistant to thermal shock, stainless, fully austenitic. Low expansion coefficient between C-steel and austenitic CrNi(Mo) steel. The wire and the weld metal meet the highest quality requirements.

## Marks (rods only)

front:  2.4831  
back: ERNiCrMo-3

## Base materials

2.4856 NiCr22Mo9Nb, 2.4858 NiCr21Mo, 2.4816 NiCr15Fe, 1.4583 X10CrNiMoNb18-12, 1.4876 X10NiCrAlTi32-21, 1.4529 X1NiCrMoCuN25-20-7, X2CrNiMoCuN20-18-6, 2.4641 NiCr2 Mo6Cu. Joints of the above-mentioned materials with unalloyed and low-alloy steels such as P265GH, P285NH, P295GH, S355N, 16Mo3, X8Ni9, ASTM A 553 Gr.1, N 08926, Alloy 600, Alloy 625, Alloy 800 (H), 9% Ni steels

## Typical composition of welding rod (Wt-%)

C	Si	Mn	Cr	Ni	Mo	Nb	Fe	Ti
≤0,02	0,1	0,1	22	bal.	9,0	3,6	≤0,5	+

## Mechanical properties of all-weld metal

Heat Treatment	Yield strength	Tensile strength	Elongation	Impact values	
	0,2%		( $L_0=5d_0$ )	in J CVN	
	MPa	MPa	%	+20°C:	-196°C:
untreated	540	800	38	160	130

## Operating data



Polarity = -

 shielding gases: 100% Argon  
Ar + He mixed gas

## Dimensions (mm)

1,6      2,0      2,4

## Approvals and certificates

TÜV-D (04324.), Statoil, SEPROZ, CE (NiCr 625-IG A: TÜV-D (09405.), DB (43.014.25), CE)

# Thermanit 625

TIG rod

## Classifications

EN ISO 18274

AWS A5.9:

S Ni 6625 (NiCr22Mo9Nb)

ERNiCrMo-3

## Characteristics and field of use

Nickel based alloy; high resistance to corrosive environment. Resistant to stress corrosion cracking. Resistant to scaling up to 1100 °C (2012 °F). Temperature limit: 500°C (932°F) max. in sulphureous atmospheres. High temperature resistant up to 1000 °C (1832 °F). Cold toughness at subzero temperatures as low as -196 °C (-321 °F). For joining and surfacing work with matching/similar corrosion-resistant materials as well as on matching and similar heat resistant, high temperature resistant steels and alloys. For joining and surfacing work on cryogenic austenitic CrNi(N) steels/cast steel grades and on cryogenic Ni steels suitable for quenching and tempering.

## Marks (rods only)

 2.4831 / ERNiCrMo-3

## Base materials

TÜV-certified parent metal

1. 4547 – Alloy 254SMO – UNS S31254 – X1CrNiMoCuN20-18-7

1. 4876 – Alloy 800 – UNS N08800 – X10NiCrAlTi32-20

1. 4958 – Alloy 800 H – UNS N08810 – X5NiCrAlTi31-20

2. 4816 – Alloy 600 – UNS N06600 – NiCr15Fe

2. 4856 – Alloy 625 – UNS N06625 – NiCr22Mo9Nb

and combinations of aforementioned materials with ferritic steels up to S355J, 10CrMo9-10 and 9% Ni steels.

## Typical composition of welding rod (Wt-%)

C	Si	Mn	Cr	Mo	Ni	Nb	Fe
0,03	0,1	0,1	22,0	9,0	Bal.	3,6	1.0

## Mechanical properties of all-weld metal

Heat Treatment	Yield strength	Tensile strength	Elongation	Impact values	
	0,2%		( $L_0=5d_0$ )	in J CVN	
	MPa	MPa	%	at room temperature	-196°C
AW	460	740	35	120	100

## Operating data



Polarity = -

Shielding gas (EN ISO 14175) I1

## Dimensions (mm)

1,6	2,0	2,4	3,2		
-----	-----	-----	-----	--	--

## Approvals and certificates

TÜV (Certificate No. 3464) DB (Reg. form No. 43.132.25) DNV (W 10652)



## Classifications

EN ISO 18274	AWS A5.14
--------------	-----------

S Ni 6625 (NiCr22Mo9Nb)	ER NiCrMo-3
-------------------------	-------------

## Characteristics and field of use

UTP A 6222 Mo has a high nickel content and is suitable for welding high-strength and high-corrosion resistant nickel-base alloys, e.g.

X1 NiCrMoCuN25206	1.4529	UNS N08926
-------------------	--------	------------

X1 NiCrMoCuN25205	1.4539	UNS N08904
-------------------	--------	------------

NiCr21Mo	2.4858	UNS N08825
----------	--------	------------

NiCr22Mo9Nb	2.4856	UNS N06625
-------------	--------	------------

It can be used for joining ferritic steel to austenitic steel as well as for surfacing on steel. It is also possible to weld 9% nickel steels using this wire due to its high yield strength. Its wide range of uses is of particular significance in aviation, in chemical industry and in applications involving seawater.

Special properties of the weld metal

The special features of the weld metal of UTP A 6222 Mo include a good creep rupture strength, corrosion resistance, resistance to stress and hot cracking. It is highly resistant and tough even at working temperatures up to 1100°C. It has an extremely good fatigue resistance due to the alloying elements Mo and Nb in the NiCr-matrix. The weld metal is highly resistant oxidation and is almost immune to stress corrosion cracking. It resists intergranular penetration without having been heat-treated.

## Typical composition of welding rod (Wt-%)

C	Si	Cr	Mo	Ni	Nb	Fe
< 0,02	< 0,2	22,0	9,0	bal.	3,5	1,0

## Mechanical properties of all-weld metal

Heat Treatment	Yield strength	Tensile strength	Elongation	Impact values	
	0,2%		( $L_0=5d_0$ )	in J CVN	
	MPa	MPa	%	+20 °C	-196 °C
untreated	460	740	30	100	85

## Operating data



Polarity = ±

Shielding gas: (EN ISO 14175)

R 1

Z-ArHeHC-30/2/0,05

## Dimensions (mm)

1,0	1,2	1,6	2,0	2,4
-----	-----	-----	-----	-----

## Approvals and certificates

TÜV (No. 03460;03461), GL, DNV, ABS, LR (1,2mm MIG)

## Classifications

EN ISO 18274:

AWS A5.9:

S Ni 6082 (NiCr20Mn3Nb)

ERNiCr-3

## Characteristics and field of use

TIG welding rod for high-quality welded joints to nickel-based alloys, creep resistant and highly creep resistant materials, heat resistant and cryogenic materials, and also for low-alloy, hard-to-weld steels and dissimilar joints. Also for ferrite-austenite joints at operating temperatures  $\geq 300^{\circ}\text{C}$  or heat treatments. Suitable for pressure vessel construction for  $-196^{\circ}\text{C}$  to  $+550^{\circ}\text{C}$ , otherwise with scaling resistance up to  $+1200^{\circ}\text{C}$  (sulphur-free atmosphere). Does not tend to embrittlement, high resistance to hot cracking, in addition to which the C-diffusion at high temperatures or during heat treatment of dissimilar joints is largely inhibited. Resistant to thermal shock, stainless, fully austenitic. Low expansion coefficient between C-steel and austenitic Cr-Ni-(Mo) steel. The wire and the weld metal meet the highest quality requirements..

## Marks (rods only)

front:  2.4806  
back: ERNiCr-3

## Base materials

2.4816 NiCr15Fe, 2.4817 LC-NiCr15Fe, Alloy 600, Alloy 600 L

Nickel and nickel alloys, low-temperature steels up to X8Ni9, high-alloy Cr and CrNiMo steels, particularly for dissimilar joints, and their joints to unalloyed, low-alloy, creep resistant and highly creep resistant steels. Also suitable for the Alloy 800 material.

## Typical composition of welding rod (Wt-%)

C	Si	Mn	Cr	Ni	Ti	Nb	Fe
0.02	0,1	3,1	20,5	bal.	+	2,6	$\leq 1$

## Mechanical properties of all-weld metal

Heat Treatment	Yield strength	Tensile strength	Elongation	Impact values	
	0,2%		( $L_0=5d_0$ )	in J CVN	
	MPa	MPa	%	+20°C:	-196°C:
untreated	440	680	42	190	100

## Operating data

 Polarity = - 100% Argon  
Ar + He mixed gas

## Dimensions (mm)

1,6	2,0	2,4			
-----	-----	-----	--	--	--

## Approvals and certificates

TÜV-D (04328.), Statoil, NAKS, SEPROZ, CE (NiCr 70 Nb-IG A: TÜV-D (09403.), CE)

## Similar alloy filler metals

SMAW electrode:	FOX NIBAS 70/20	SAW combination:	NIBAS 70/20-UP/BB 444
Flu cored wire:	NIBAS 70/20-FD NIBAS 70/20 Mn-FD	GMAW solid wire:	NIBAS 70/20-IG NiCr 70 Nb-IG A*

# Thermanit Nicro 82

TIG rod

Classifications		high-alloyed	
EN ISO 18274	AWS A5.14		
S Ni 6082 (NiCr20Mn3Nb)	ERNiCr-3		

## Characteristics and field of use

Stainless; heat resistant; high temperature resistant. Cold toughness at subzero temperatures as low as -269 °C (-452 °F). Good for welding austenitic-ferritic joints. No Cr carbide zone that become brittle in the ferrite weld deposit transition zone, even as a result of heat treatments above 300 °C (572 °F). Good for fabricating tough joints and surfacing with heat resistant Cr and CrNi steels/cast steel grades and Ni-base alloys. Temperature limits: 500 °C (932 °F) in sulphurous atmospheres, 800 °C max. (1472 °F) for fully stressed welds. Resistant to scaling up to 1000 °C (1832 °F).

## Marks (rods only)

 2.4806 / ERNiCr-3

## Base materials

TÜV-certified parent metals

1.4876 – Alloy 800 – UNS N08800 – X10NiCrAlTi32-20

1.4877 – X5NiCrCeNb32-27

1.4958 – Alloy 800 H – UNS N08810 – X5NiCrAlTi31-20

2.4816 – Alloy 600 – UNS N06600 – NiCr15Fe

2.4817 – Alloy 600 L – UNS N06600 – LC-NiCr15Fe

2.4858 – Alloy 825 – UNS N08825 – NiCr21Mo

2.4851 – Alloy 601 – UNS N06601 – NiCr23Fe

Combinations of

1.4539 – X1NiCrMoCu25-20-5; 1.4583 – X10CrNiMoNb18-12

and ferritic boiler steels;

1.5662 – X8Ni9; 1.7380 – 10CrMo9-10

## Typical composition of welding rod (Wt-%)

C	Si	Mn	Cr	Ni	Nb	Fe
0,02	0,1	3,0	20,0	>67,0	2,5	2

## Mechanical properties of all-weld metal

Heat Treatment	Yield strength	Tensile strength	Elongation	Impact values
	0,2%		( $L_0=5d_0$ )	
	MPa	MPa	%	in J CVN
untreated	400	620	35	at room temperature
				150

## Operating data



Polarity = -

Shielding gas (EN ISO 14175) I1

## Dimensions (mm)

1,6	2,0	2,4	3,2		
-----	-----	-----	-----	--	--

## Approvals and certificates

TÜV (Certificate No. 1703) DB (Reg. form No. 43.132.11)

## Classifications

EN ISO 18274

AWS A5.14

S Ni 6082 (NiCr20Mn3Nb)

ER NiCr-3

## Characteristics and field of use

UTP A 068 HH is predominantly used for joining identical or similar high heat resistant Ni-base alloys, heat resistant austenites, and for joining heat resistant austenitic-ferritic materials such as

2.4816	NiCr15Fe	UNS N06600
2.4817	LC- NiCr15Fe	UNS N10665
1.4876	X10 NiCrAlTi 32 20	UNS N08800
1.6907	X3 CrNiN 18 10	

Also used for joinings of high C content 25/35 CrNi cast steel to 1.4859 or 1.4876 for petrochemical installations with working temperatures up to 900° C.

## Welding characteristics and special properties of the weld metal

The welding deposit is hot cracking resistant and does not tend to embrittlement.

## Welding instruction

Clean weld area thoroughly. Keep heat input as low as possible and interpass temperature at approx. 150° C.

## Typical composition of welding rod (Wt-%)

C	Si	Mn	Cr	Ni	Nb	Fe
0.02	0.2	3,0	20,0	balance	2,7	0,8

## Mechanical properties of all-weld metal

Heat Treatment	Yield strength 0,2%	Tensile strength	Elongation ( $L_0=5d_0$ )	Impact values in J CVN	
	MPa	MPa	%	+20 °C	-196 °C
untreated	380	640	35	160	80

## Operating data



Shielding gas: I1 R1

## Dimensions (mm)

1,6	2,0	2,4	3,2
-----	-----	-----	-----

## Approvals and certificates

TÜV (No. 00882; 00883), KTA, ABS, GL, DNV

# Thermanit 617

TIG rod

Classifications		high-alloyed	
EN ISO 18274	AWS A5.14:		
S Ni 6617 (NiCr22Co12Mo9)	ERNiCrCoMo-1		

## Characteristics and field of use

Resistant to scaling up to 1100 °C (2012 °F), high temperature resistant up to 1000 °C (1832 °F). High resistance to hot gases in oxidizing resp. carburizing atmospheres. For joining and surfacing applications with matching and similar heat resistant steels and alloys.

## Marks (rods only)

 2.4627 / ERNiCrCoMo-1

## Base materials

### TÜV-certified parent metal

1.4859 – UNS N08810 – GX10NiCrSiNb32-20  
1.4876 – Alloy 800 – UNS N08800 – X10NiCrAlTi32-20  
1.4958 – Alloy 800 H – UNS N08810 – X5NiCrAlTi31-20  
2.4851 – Alloy – 601 – UNS N06601 – NiCr23Fe  
2.4663 – Alloy 617 – UNS N06617 – NiCr23Co12Mo

## Typical composition of welding rod (Wt-%)

C	Si	Mn	Cr	Mo	Ni	Co	Al	Ti	Fe
0,05	0,1	0,1	21,5	9,0	Bal.	11,0	1,3	0,5	1,0

## Mechanical properties of all-weld metal

Heat Treatment	Yield strength 0,2%	Tensile strength	Elongation ( $L_0=5d_0$ )	Impact values in J CVN
	MPa	MPa	%	at room temperature
AW	450	700	30	60

## Operating data

 Polarity = –      Shielding gas (EN ISO 14175) I1

## Dimensions (mm)

1,6	2,0	2,4	3,2			
-----	-----	-----	-----	--	--	--

## Approvals and certificates

TÜV (No.6845)

## Classifications

EN ISO 18274

AWS A5.14

S Ni 6617 (NiCr22Co12Mo9)

ER NiCrCoMo-1

## Characteristics and field of use

UTP A 6170 Co is particularly used for joining heat resistant and creep resistant nickel base alloys of identical and similar nature, high temperature austenitic and cast alloys, such as

 1.4958  
 1.4959  
 2.4663

 X5NiCrAlTi 31 20  
 X8NiCrAlTi 32 21  
 NiCr23Co12Mo

 UNS N08810  
 UNS N08811  
 UNS N06617

## Welding characteristics and special properties of the weld metal

The weld metal is resistant to hot-cracking. It is used for operating temperatures up to 1100° C. Scale-resistant at temperatures up to 1100° C in oxidizing resp. carburizing atmospheres, e. g. gas turbines, ethylene production plants.

## Welding instruction

Clean welding area carefully. Keep heat input as low as possible and interpass temperature at max. 150° C.

## Typical composition of welding rod (Wt-%)

C	Si	Co	Cr	Mo	Ni	Ti	Al	Fe
0.06	0.3	11,5	22,0	8,5	bal.	0,4	1,0	1,0

## Mechanical properties of all-weld metal

Heat Treatment	Yield strength 0,2%	Tensile strength	Elongation ( $L_0=5d_0$ )	Impact values in J CVN	
	MPa	MPa	%	at room temperature	
untreated	450	750	30	120	

## Operating data



Shielding gas: (EN ISO 14175)  
 I1  
 R1

## Dimensions (mm)

1,6      2,0      2,4      3,2

## Approvals and certificates

TÜV (No. 05450; 05451)

## Classifications

EN ISO 18274

AWS A5.14

S Ni 6276 (NiCr15Mo16Fe6W4)

ER NiCrMo-4

## Characteristics and field of use

UTP A 776 is suitable for joint welding of matching base materials, as

2.4819

NiMo16Cr15W

UNS N10276

and surface weldings on low-alloyed steels. UTP A 776 is employed primarily for welding components in plants for chemical processes with highly corrosive media, but also for surfacing press tools, punches, etc. which operate at high temperature.

## Welding characteristics and special properties of the weld metal

Excellent resistance against sulphuric acids at high chloride concentrations.

## Welding instruction

To avoid intermetallic precipitations, stick electrodes should be welded with lowest possible heat input and interpass temperature.

## Typical composition of welding rod (Wt-%)

C	Si	Cr	Mo	Ni	V	W	Fe
0.01	0.07	16.0	16.0	balance	0,2	3,5	6,0

## Mechanical properties of all-weld metal

Heat Treatment	Yield strength 0,2%	Tensile strength	Elongation ( $L_0=5d_0$ )	Impact values in J CVN	
	MPa	MPa	%	at room temperature	
untreated	450	750	30	90	

## Operating data



Shielding gas: (EN ISO 14175)  
R1

## Dimensions (mm)

1,6

2,0

2,4

3,2

## Approvals and certificates

TÜV (No. 05586; 05587)

# Thermanit Nimo C 24

TIG rod

Classifications		high-alloyed	
EN ISO 18274	AWS A5.14:		
S Ni 6059 (NiCr23Mo16)	ERNiCrMo-13		

## Characteristics and field of use

Nickel based alloy. High corrosion resistance in reducing and, above all, in oxidizing environments. For joining and surfacing with matching and similar alloys and cast alloys. For welding the clad side of plates of matching and similar alloys.

## Marks (rods only)

 2.4607 / ERNiCrMo-13

## Base materials

### TÜV-certified parent metals

- 1.4565 – Alloy 24 – UNS S34565 – X2CrNiMnMoNbN25-18-5-4
- 2.4602 – Alloy C-22 – UNS N06022 – NiCr21Mo14W
- 2.4605 – Alloy 59 – UNS N06059 – NiCr23Mo16Al
- 2.4610 – Alloy C-4 – UNS N06455 – NiMo16Cr16Ti
- 2.4819 – Alloy C-276 – UNS N10276 – NiMo16Cr15W

## Typical composition of welding rod (Wt-%)

C	Si	Mn	Cr	Mo	Ni	Fe	
0,01	0.10	0.5	23,0	16,0	Bal.	<1,5	

## Mechanical properties of all-weld metal

Heat Treatment	Yield strength	Tensile strength	Elongation	Impact values
	0,2%		( $L_0=5d_0$ )	in J CVN
	MPa	MPa	%	at room temperature
AW	450	700	35	120

## Operating data



Polarity = -

Shielding gas (EN ISO 14175) I1

## Dimensions (mm)

1,6	2,0	2,4	3,2			
-----	-----	-----	-----	--	--	--

## Approvals and certificates

TÜV (Certificate No. 6462) GL (NiCr23Mo16)



## Classifications

EN ISO 18274

AWS A5.14

S Ni 6059 (NiCr23Mo16)

ER NiCrMo-13

## Characteristics and field of use

UTP A 759 is suitable for welding components in plants for chemical processes with highly corrosive media. For joining materials of the same or similar natures, e. g.

2.4602	NiCr21Mo14W	UNS N06022
2.4605	NiCr23Mo16Al	UNS N06059
2.4610	NiMo16Cr16Ti	UNS N06455
2.4819	NiMo16Cr15W	UNS N10276

and these materials with low alloyed steels such as for surfacing on low alloyed steels.

## Welding characteristics and special properties of the weld metal

Good corrosion resistance against acetic acid and acetic hydride, hot contaminated sulphuric and phosphoric acids and other contaminated oxidising mineral acids. Intermetallic precipitation will be largely avoided.

## Welding instruction

The welding area has to be free from impurities (oil, paint, markings). Minimize heat input. The interpass temperature should not exceed 150 °C. Linear energy input < 12 kJ/cm

## Typical composition of welding rod (Wt-%)

C	Si	Cr	Mo	Ni	Fe
0.01	0.1	22,5	15,5	balance	1.0

## Mechanical properties of all-weld metal

Heat Treatment	Yield strength 0,2%	Tensile strength	Elongation ( $L_0=5d_0$ )	Impact values in J CVN	
	MPa	MPa	%	at room temperature	
untreated	450	720	35	100	

## Operating data



Shielding gas: (EN ISO 14175)  
R1

## Dimensions (mm)

0,8	1,0	1,2	1,6		
-----	-----	-----	-----	--	--

## Approvals and certificates

TÜV (No. 06065; 06068), GL

## Classifications

EN ISO 18274

AWS A5.14

S Ni 4060 (NiCu30Mn3Ti)

ER NiCu-7

## Characteristics and field of use

Particularly suited for the following materials: 2.4360 NiCu30Fe, 2.4375 NiCu30Al.

UTP A 80 M is also used for joining different materials, such as steel to copper and copper alloys, steel to nickel-copper alloys. These materials are employed in high-grade apparatus construction, primarily for the chemical and petrochemical industries. A special application field is the fabrication of seawater evaporation plants and marine equipment.

## Welding characteristics and special properties of the weld metal

The weld metal has an excellent resistance to a large amount of corrosive medias, from pure water to non-oxidising mineral acids, alkali and salt solutions

## Welding instruction

Clean the weld area thoroughly to avoid porosity. Opening groove angle about 70°. Weld stringer beads.

## Typical composition of welding rod (Wt-%)

C	Si	Mn	Cu	Ni	Ti	Fe
0,02	0,3	3,2	29,0	balance	2,4	6,0

## Mechanical properties of all-weld metal

Heat Treatment	Yield strength 0,2%	Tensile strength	Elongation ( $L_0=5d_0$ )	Impact values in J CVN	
	MPa	MPa	%	at room temperature	
untreated	300	450	30	80	

## Operating data



Shielding gas: (EN ISO 14175)  
I1

## Dimensions (mm)

0,8	1,0	1,2			
-----	-----	-----	--	--	--

## Approvals and certificates

TÜV (No. 00249; 00250), ABS, GL



## Chapter 3.1 - (GMAW) Solid wire (unalloyed, low-alloyed)

Product name	EN ISO	AWS	Page
BOHLER EMK 6	G 42 4 M21 3Si1 / G 42 4 C1 3Si1	ER70S-6	2
Union K 52	G 42 2 C1 3Si1 / G 46 4 M21 3Si1	ER70S-6	3
BOHLER EMK 8	G 46 4 M21 4Si1 / G 46 4 C1 4Si1	ER70S-6	4
Union K 56	G 46 2 C G4Si1 / G 46 4 M G4Si1	ER70S-6	5
BOHLER NICU 1-IG	G 42 4 M21 Z3Ni1Cu / G 42 4 C1 Z3Ni1Cu	ER80S-G	6
BOHLER NiMo 1-IG	G 55 6 M21 Mn3Ni1Mo / G 55 4 C1 Mn3Ni1Mo	ER90S-G	7
Union MoNi	G 62 5 M21 Mn3Ni1Mo	ER90S-G	8
Union NiMoCr	G 69 6 M21 Mn4Ni1,5CrMo	ER100S-G	9
BOHLER NiCrMo 2,5-IG	G 69 6 M21 Mn3Ni2,5CrMo / G 69 4 C1 Mn3Ni2,5CrMo	ER110S-G	10
BOHLER X 70-IG	G 69 5 M21 Mn3Ni1CrMo	ER110S-G	11
Union X 85	G 79 5 M21 Mn4Ni1,5CrMo	ER110S-G	12
BOHLER X 90-IG	G 89 6 M21 Mn4Ni2CrMo	ER120S-G	13
Union X 90	G 89 6 M21 Mn4Ni2CrMo	ER120S-G	14
Union X 96	G 89 5 M21 Mn4Ni2,5CrMo	ER120S-G	15
BOHLER DMO-IG	G MoSi	ER70S-A1	16
Union I Mo	G MoSi	ER80S-G(A1)	17
BOHLER DCMS-IG	G CrMo1Si	ER80S-G ER80S-B2 (mod.)	18
Union I CrMo	G CrMo1Si	ER80S-G ER80S-B2 (mod.)	19
BOHLER CM 2-IG	G CrMo2Si	ER90S-B3 (mod.)	20
BOHLER C 9 MV-IG	G CrMo91	ER90S-B9	21
Thermanit MTS 3	G CrMo91	ER90S-B9	22
Union I CrMo 910	G CrMo2Si	ER90S-G	23
Thermanit MTS 616	GZ CrMoWVNb 9 0,5 1,5	ER90S-G ER90S-B9(mod.)	24
Thermanit ATS 4	G 19 9 H	ER19-10H	25
Union K 5 Ni	G 50 5 M21 3Ni1/G 46 3 C1 3Ni1	ER80S-G	26
BOHLER SG 8-P	G 42 5 M21 3Ni1	ER80S-G	27
BOHLER 2.5 Ni-IG	G 46 8 M21 2Ni2	ER80S-Ni2	28
Union K 52 Ni	G 50 6 M21 Z3Ni1/G 46 4 C1 Z3Ni1	ER80S-G ER80S-Ni1(mod.)	29
Union K NOVA Ni	G 42 5 M21 3Ni1	ER80S-G ER80S-Ni1(mod.)	30
Union Ni 2,5	G 50 7 M21 2Ni2	ER80S-Ni2	31

## Classifications

unalloyed

EN ISO 14341-A:

AWS A5.18:

G 42 4 M21 3Si1/G 42 4 C1 3Si1

ER70S-6

## Characteristics and field of use

Universally applicable copper coated wire electrode with a largely spatter-free material transfer whether using mixed gases or under CO<sub>2</sub>. The wire electrode is suitable for joint welding in the construction of boilers, containers and building structures. Through its ability to withstand high currents it also offers the ideal properties for thick sheet welding. The version of the solid wire electrode without copper coating is also available as a TOP version, and is designed for minimum tendency to splatter and the ideal feeding characteristics even at high wire feed rates. These versions are particularly used for automated welding.

## Base materials

Steels up to a yield strength of 420 MPa (60 ksi)

S235JR-S355JR, S235JO-S355JO, S235J2-S355J2, S275N-S420N, S275M-S420M, P235GH-P355GH, P275NL1-P355NL1, P215NL, P265NL, P355N, P285NH-P420NH, P195TR1-P265TR1, P195TR2-P265TR2, P195GH-P265GH, L245NB-L415NB, L245MB-L415MB, GE200-GE240, shipbuilding steels: A, B, D, E, A 32-E 36

ASTM A 106 Gr. A, B, C; A 181 Gr. 60, 70; A 283 Gr. A, C; A 285 Gr. A, B, C; A 350 Gr. LF1;

A 414 Gr. A, B, C, D, E, F, G; A 501 Gr. B; A 513 Gr. 1018; A 516 Gr. 55, 60, 65, 70;

A 573 Gr. 58, 65, 70; A 588 Gr. A, B; A 633 Gr. C; A 662 Gr. B; A 711 Gr. 1013; A 841 Gr. A;

API 5 L Gr. B, X42, X52, X56, X60

## Typical composition of solid wire (Wt-%)

C	Si	Mn		
0,08	0,9	1,45		

## Mechanical properties of all-weld metal

Heat Treatment	Yield strength 0,2%	Tensile strength	Elongation (L <sub>0</sub> =5d <sub>0</sub> )	Impact values in J CVN	
	MPa	MPa	%	+20°C:	-40°C
untreated	440	560	30	160	80
stress relieved*	380	490	30	160	

\* 600°C/2 h – shielding gas 100% Argon + 15-25% CO<sub>2</sub>

## Operating data

	Polarity = +	shielding gases: Argon + 15-25% CO <sub>2</sub> 100% CO <sub>2</sub>
---	--------------	--

## Dimensions (mm)

0,8	1,0	1,2	1,6
-----	-----	-----	-----

## Approvals and certificates

TÜV-D (3036), DB (42.014.11), ABS (3SA, 3 SA), CWB (X), DNV (III MS), GL (3 S), LR (3S, 3 S H15), LTSS, SEPPOZ, CE

Classifications		unalloyed
EN ISO 14341-A	AWS A5.18	
G 42 2 C1 3Si1/G 46 4 M21 3Si1	ER70S-6	

**Characteristics and field of use**

GMAW solid wire electrode for welding unalloyed and low alloy steels with shielding gas. All-purpose useable with gas mixture or CO<sub>2</sub>, low-spatter transfer in the short and spray arc range. Used in boiler and pipeline construction, shipbuilding, vehicle manufacturing and structural engineering.

**Base materials**

S235JRG2 - S355J2; boiler steels P235GH, P265GH, P295GH; fine grained structural steels up to S420N; ASTM A27 u. A36 Gr. all; A106 Gr. A, B; A214; A242 Gr. 1-5; A266 Gr. 1, 2, 4; A283 Gr. A, B, C, D; A285 Gr. A, B, C; A299 Gr. A, B; A328; A366; A515 Gr. 60, 65, 70; A516 Gr. 55; A556 Gr. B2A; A570 Gr. 30, 33, 36, 40, 45; A572 Gr. 42, 50; A606 Gr. all; A607 Gr. 45; A656 Gr. 50, 60; A668 Gr. A, B; A907 Gr. 30, 33, 36, 40; A851 Gr. 1, 2; A935 Gr. 45; A936 Gr. 50

**Typical composition of solid wire (Wt-%)**

C	Si	Mn		
0,08	0,85	1,5		

**Mechanical properties of all-weld metal**

Shielding Gas	Yield strength 0,2%	Tensile strength	Elongation (L <sub>0</sub> =5d <sub>0</sub> )	Impact values in J CVN		
				+20°C:	-20°C:	-40°C:
	MPa	MPa	%			
CO <sub>2</sub>	420	540	25	85	47	-
M21	440	560	24	95	60	47

**Operating data**

	Polarity = +	Shielding gas (EN ISO 14175) M1 - M3 and C1
---	--------------	--

**Dimensions (mm)**

0,8	1,0	1,2	1,6
-----	-----	-----	-----

**Approvals and certificates**

TÜV (Certificate No. 106), DB (Reg. form No. 42.132.02), ABS, GL (3YHS), LR, DNV

## Classifications

unalloyed

EN ISO 14341-A:

AWS A5.18:

G 46 4 M21 4Si1/ G 46 4 C1 4Si1

ER70S-6

## Characteristics and field of use

Copper coated wire electrode applicable universally in the construction of boilers, containers and building structures. It exhibits a largely spatter-free material transfer both under mixed gases and under CO<sub>2</sub>. Through its ability to withstand high currents it has ideal properties for thick sheet welding. Use low-diameter wire for vertical down welds.

The version of the solid wire electrode without copper coating is also available as a TOP version, and it has been designed for minimum tendency to splatter and the ideal feeding characteristics even at high wire feed rates. These versions are particularly used for automated welding.

## Base materials

Steels up to a yield strength of 460 MPa (67 ksi) S235JR-S355JR, S235JO-S355JO, S450JO, S235J2-S355J2, S275N-S460N, S275M-S460M, P235GH-P355GH, P275NL1-P460NL1, P215NL, P265NL, P355N, P285NH-P460NH, P195TR1-P265TR1, P195TR2-P265TR2, P195GH-P265GH, L245NB-L415NB, L450QB, L245MB-L450MB, GE200-GE240, shipbuilding steels: A, B, D, E, A 32-E 36 ASTM A 106 Gr. A, B, C; A 181 Gr. 60, 70; A 283 Gr. A, C; A 285 Gr. A, B, C; A 350 Gr. LF1; A 414 Gr. A, B, C, D, E, F, G; A 501 Gr. B; A 513 Gr. 1018; A 516 Gr. 55, 60, 65, 70; A 573 Gr. 58, 65, 70; A 588 Gr. A, B; A 633 Gr. C, E; A 662 Gr. B; A 711 Gr. 1013; A 841 Gr. A; API 5 L Gr. B, X42, X52, X56, X60, X65

## Typical composition of solid wire (Wt-%)

C	Si	Mn		
0,1	1,0	1,7		

## Mechanical properties of all-weld metal

Heat Treatment	Yield strength	Tensile strength	Elongation	Impact values	
	0,2%		( $L_0=5d_0$ )	in J CVN	
	MPa	MPa	%	+20°C:	-40°C
untreated *	480	620	26	150	80
untreated 1**	470	580	28	110	50
stress relieved***	410	540	28	130	70

\* untreated, as-welded – shielding gas Ar + 15-25% CO<sub>2</sub>

\*\* untreated, as-welded – shielding gas 100% CO<sub>2</sub>

\*\*\* stress relieved, 600°C/2 h – shielding gas Ar + 15-25% CO<sub>2</sub>

## Operating data

	Polarity = +	shielding gases: Argon + 15-25% CO <sub>2</sub> 100% CO <sub>2</sub>
---	--------------	--

## Dimensions (mm)

0,8	1,0	1,2	
-----	-----	-----	--

## Approvals and certificates

TÜV-D (3038.), DB (42.014.05), ABS (3SA, 3 SA), DNV (III MS), GL (3 S), LR (3S, 3 S H15), SEPROZ, CE, NAKS

Classifications		unalloyed	
EN ISO 14341-A	AWS A5.18		
G 46 2 C G4Si1/ G 46 4 M G4Si1	ER70S-6		

### Characteristics and field of use

GMAW solid wire electrode for welding unalloyed and low alloy steels with CO<sub>2</sub> or gas mixture. Low spatter transfer in short and spray arc range. High arc stability also at high welding current amperage. Large application range; specially suited for steels of higher strength in boiler and pipeline construction, shipbuilding, vehicle manufacturing and structural engineering.

### Base materials

S235JRG2 - S355J2; boiler steels P235GH, P265GH, P295GH, P355GH; fine grained structural steels up to S460N; ASTM A27 and A36 Gr. all; A106 Gr. A, B; A214; A242 Gr. 1-5; A266 Gr. 1, 2, 4; A283 Gr. A, B, C, D; A285 Gr. A, B, C; A299 Gr. A, B; A328; A366; A515 Gr. 60, 65, 70; A516 Gr. 55; A556 Gr. B2A; A570 Gr. 30, 33, 36, 40, 45; A572 Gr. 42, 50; A606 Gr. all; A607 Gr. 45; A656 Gr. 50, 60; A668 Gr. A, B; A907 Gr. 30, 33, 36, 40; A851 Gr. 1, 2; A935 Gr. 45; A936 Gr. 50

### Typical composition of solid wire (Wt-%)

C	Si	Mn		
0,08	1,05	1,65		

### Mechanical properties of all-weld metal

Shielding Gas	Yield strength 0,2%	Tensile strength	Elongation (L <sub>0</sub> =5d <sub>0</sub> )	Impact values in J CVN		
				+20°C:	-20°C:	-40°C:
	MPa	MPa	%			
CO <sub>2</sub>	450	550	25	90	47	-
M21	480	580	24	95	65	47

### Operating data

	Polarity = +	Shielding gas (EN ISO 14175) M2, M3, C1
---	--------------	--

### Dimensions (mm)

0,8	1,0	1,2	1,6
-----	-----	-----	-----

### Approvals and certificates

TÜV (Certificate No. 0376), DB (Reg. form No. 42.132.01), ABS, BV, GL (3YHS), LR, DNV



## Classifications

low-alloyed

EN ISO 14341-A:

AWS A5.28:

G 42 4 M21 Z3Ni1Cu/ G 42 4 C1 Z3Ni1Cu

ER80S-G

## Characteristics and field of use

Ni-Cu alloyed wire electrode, copper coated for gas shielded metal arc welding on weatherproof structural steels and special structural steels. BÖHLER NiCu 1 IG achieves good welding both with short arcs at low voltage as well as with spray arcs at higher voltage. The mechanical properties of the weld metal, the resistance to porosity and the bead formation depend on the kind of shielding gas used and on the other welding parameters. Due to the alloyed copper, the weld metal features increased resistance to atmospheric corrosion.

## Base materials

weatherproof structural steels

S235JRG2Cu, S235J2G4Cu, S235J0Cu, S235JRW, S355J0Cu, S355J2G3Cu, S355J0W, S235J2W-S355J2W, S355K2W ASTM A 588 Gr. A, B, C, K; A 618 Gr. II; 709 Gr. C

## Typical composition of solid wire (Wt-%)

C	Si	Mn	Cu	Ni
0,1	0,5	1,1	0,4	0,9

## Mechanical properties of all-weld metal

Heat Treatment	Yield strength 0,2%	Tensile strength	Elongation ( $L_0=5d_0$ )	Impact values in J CVN	
				+20°C:	-40°C
untreated *	500	580	26	130	(≥ 47)
stressed relieved**	460	540	27	130	

\*untreated, as-welded – shielding gas Ar + 15-25% CO<sub>2</sub> or 100% CO<sub>2</sub>\*\*stress relieved, 600°C/2 h – shielding gas Ar + 15-25% CO<sub>2</sub> or 100% CO<sub>2</sub>

## Operating data

	Polarity = +	shielding gases: Argon + 15-25% CO <sub>2</sub> 100% CO <sub>2</sub>
--	--------------	--

## Dimensions (mm)

0,8	1,0	1,2	
-----	-----	-----	--

## Approvals and certificates

DB (42.014.08), CE

# BÖHLER NiMo 1-IG

Solid Wire

Classifications		low-alloyed
EN ISO 16834-A:	AWS A5.28:	
G 55 6 M21 Mn3Ni1Mo/ G 55 4 C1 Mn3Ni1Mo	ER90S-G	

## Characteristics and field of use

Copper coated wire electrode for gas shielded arc welding of high-strength, quenched and tempered fine-grained steels. Thanks to the precise addition of micro-alloying elements, BÖHLER NiMo1-IG yields a weld metal that features exceptional ductility and high resistance to cracking. Good low-temperature impact energy down to -60°C, flawless feeding characteristics, good copper adhesion and a low total copper content are further quality features. For joint welding in steel, container, pipeline and apparatus construction. Approved for armour plates. Also suitable for low-temperature applications. The chemical composition, including the Ni content, meets the NORSOK specifications for „water injection systems“.

## Base materials

quenched and tempered and cryogenic/creep-resistant fine-grained structural steels S460N, S460M, S460NL, S460ML, S460Q-S555Q, S460QL-S555QL, S460QL1-S555QL1, 460N, P460NH, P460NL1, P460NL2, L415NB, L415MB-L555MB, L415QB-L555QB, alform 500 M, 550 M, aldur 500 Q, 500 QL, 500 QL1, aldur 550 Q, 550 QL, 550 QL1, 20MnMoNi4-5, 15NiCuMoNb5-6-4 ASTM A 572 Gr. 65; A 633 Gr. E; A 738 Gr. A; A 852; API 5 L X60, X65, X70, X80, X60Q, X65Q, X70Q, X80Q

## Typical composition of solid wire (Wt-%)

C	Si	Mn	Mo	Ni
0,08	0,6	1,8	0,3	0,9

## Mechanical properties of all-weld metal

Heat Treatment	Yield strength 0,2%	Tensile strength	Elongation ( $L_0=5d_0$ )	Impact values in J CVN		
	MPa	MPa	%	+20°C:	-40°C	-60°C
untreated *	620	700	23	140	110	(≥ 47)
untreated 1**	590	680	22	120	(≥ 47)	

\* untreated, as-welded – shielding gas Ar + 15-25% CO<sub>2</sub>

\*\* untreated, as-welded – shielding gas 100% CO<sub>2</sub>

## Operating data

	Polarity = +	shielding gases: Argon + 15-25% CO <sub>2</sub> 100% CO <sub>2</sub>
---	--------------	--

## Dimensions (mm)

0,8	1,0	1,2	
-----	-----	-----	--

## Approvals and certificates

TÜV-D (11763), DB (42.014.06), GL (4 55S), SEPPOZ, NAKS (1.2 mm), Gazprom (1.2 mm), CE, VG 95132

# Union MoNi

Solid Wire

## Classifications

low-alloyed

EN ISO 16834-A

AWS A5.28

G 62 5 M21 Mn3Ni1Mo

ER90S-G

## Characteristics and field of use

Medium alloy solid wire electrode for shielded arc welding of quenched and tempered and thermo-mechanically treated fine grained structural steels; creep resistant structural steels with higher yield strength. Outstanding toughness values of the weld metal at low temperatures when deposited with CO<sub>2</sub> and gas mixture.

## Base materials

S550QL - S620QL, S550MC, P550M, 15 NiCuMoNb 5, 20 MnMoNi 55 etc; API Spec. 5L: X70, X80; ASTM A517 Gr. A, B, C, E, F, H, J, K, M, P; A255 Gr. C; A633 Gr. E; A572 Gr. 65

## Typical composition of solid wire (Wt-%)

C	Si	Mn	Mo	Ni
0,1	0,65	1,55	0,40	1,10

## Mechanical properties of all-weld metal

Shielding Gas	Yield strength 0,2%	Tensile strength	Elongation ( $L_0=5d_p$ )	Impact values in J CVN		
	MPa	MPa	%	+20°C:	-40°C:	-60°C:
CO <sub>2</sub>	550	640	20	80	47	-
M21	620	700	18	100		47

## Operating data



Polarity = +

Shielding gas (EN ISO 14175) M2, M3 and C1

## Dimensions (mm)

0,8

1,0

1,2

## Approvals and certificates

TÜV (Certificate No. 926), DB (Reg. form No. 42.132.09), GL, DNV, WIWEB

# Union NiMoCr

Solid Wire

Classifications		low-alloyed	
EN ISO 16834-A	AWS A5.28		
G 69 6 M21 Mn4Ni1,5CrMo	ER100S-G		

## Characteristics and field of use

Medium alloy solid wire electrode for shielded arc welding of quenched and tempered and thermo-mechanically treated fine grained structural steels; for joint welding of wear resistant steels. For use with CO<sub>2</sub> and gas mixture. Outstanding toughness of the weld metal at low temperatures. For use in crane and vehicle manufacturing.

## Base materials

S690QL1 (alform 700 M; aldur 700 QL1; S620QL1, S700MC (alform 700 M))

## Typical composition of solid wire (Wt-%)

C	Si	Mn	Cr	Mo	Ni
0,08	0,6	1,70	0,2	0,5	1,50

## Mechanical properties of all-weld metal

Shielding Gas	Yield strength 0,2%	Tensile strength	Elongation (L <sub>0</sub> =5d <sub>0</sub> )	Impact values in J CVN		
	MPa	MPa	%	+20°C:	-40°C:	-60°C:
CO <sub>2</sub>	680	740	18	80	47	
M21	720	780	16	100		47

## Operating data

	Polarity = +	Shielding gas (EN ISO 14175) M21 and C1
---	--------------	---

## Dimensions (mm)

0,8	1,0	1,2
-----	-----	-----

## Approvals and certificates

TÜV (Certificate No. 2760), DB (Reg. form No. 42.132.08), ABS, DNV, BV, GL (6 69S), LR

## Classifications

low-alloyed

EN ISO 16834-A:

AWS A5.28:

G 69 6 M21 Mn3Ni2.5CrMo/ G 69 4 C1 Mn3Ni2.5CrMo

ER110S-G

## Characteristics and field of use

Copper coated wire electrode for joint welding of quenched and tempered fine-grained structural steels with high requirements for low-temperature toughness (down to -60°C, depending on the shielding gas).

## Base materials

quenched and tempered fine-grained structural steels with high requirements for low-temperature toughness. S620Q, S620QL, S690Q, S690QL, S620QL1-S690QL1, alform plate 620 M, 700 M, aldur 620 Q, 620 QL, 620 QL1, aldur 700 Q, 700 QL, 700 QL1  
ASTMA 514 Gr. F, H, Q; A 709 Gr. 100 Type B, E, F, H, Q; A 709 Gr. HPS 100W

## Typical composition of solid wire (Wt-%)

C	Si	Mn	Cr	Ni	Mo
0,08	0,6	1,4	0,3	2,5	0,4

## Mechanical properties of all-weld metal

Heat Treatment	Yield strength 0,2%	Tensile strength	Elongation ( $L_0=5d_0$ )	Impact values in J CVN		
	MPa	MPa	%	+20°C:	-40°C	-60°C
untreated *	810	910	18	120		(≥ 47)
untreated 1**	780	890	17	70	(≥ 47)	

\* untreated, as-welded – shielding gas Ar + 15-25% CO<sub>2</sub>

\*\* untreated, as-welded – shielding gas 100% CO<sub>2</sub>

## Operating data



Polarity = +

shielding gases:  
Argon + 15-25% CO<sub>2</sub>  
100% CO<sub>2</sub>

## Dimensions (mm)

1,0

1,2

## Approvals and certificates

DB (42.014.07), ABS (X Q690X-5), BV (UP), DNV (5 69), GL (4 69S), LR (X), SEPROZ, CE

## Similar alloy filler metals

SMAW electrode:	FOX EV 85	GTAW rod:	NiCrMo 2.5-IG
SAW combination:	3 NiCrMo 2.5-UP/BB 24		

Classifications		low-alloyed
EN ISO 16834-A:	AWS A5.28:	
G 69 5 M21 Mn3Ni1CrMo	ER110S-G	

**Characteristics and field of use**

Copper coated wire electrode for welding high-strength, quenched and tempered fine-grained structural steels with a minimum yield strength of 690 MPa.

Thanks to the precise addition of micro-alloying elements, BÖHLER X 70 IG yields a weld metal that features exceptional ductility and high resistance to cracking in spite of its high strength. Good low-temperature impact energy down to -50 °C.

**Base materials**

High-strength fine-grained structural steels S620Q, S620QL, S690Q, S690QL, alform plate 620 M, 700 M, aldur 620 Q, 620 QL, aldur 700 Q, 700 QL ASTM A 514 Gr. F, H, Q; A 709 Gr. 100 Type E, F, H, Q; A 709 Gr. HPS 100W

**Typical composition of solid wire (Wt-%)**

C	Si	Mn	Cr	Ni	Mo	V
0,1	0,6	1,6	0,25	1,3	0,25	0,1

**Mechanical properties of all-weld metal**

Heat Treatment	Yield strength 0,2%	Tensile strength	Elongation ( $L_0=5d_0$ )	Impact values in J CVN		
	MPa	MPa	%	+20°C:	-50°C	
untreated	800	900	19	190	(≥ 47)	

**Operating data**

Polarity = +

 shielding gas:  
Argon + 15-25% CO<sub>2</sub>
**Dimensions (mm)**

1,0	1,2	
-----	-----	--

**Approvals and certificates**

TÜV-D (5547.), DB (42.014.19), ABS (X), BV (UP), DNV (IV 69), GL (5 69S), LR (X), RMR (4 69), SEPROZ, CE

**Similar alloy filler metals**

SMAW electrode:	FOX EV 85	GTAW rod:	NiCrMo 2.5-IG
SAW combination:	3 NiCrMo 2.5-UP/BB 24		

# Union X 85

Solid Wire

## Classifications

low-alloyed

EN ISO 16834-A

AWS A5.28

G 79 5 M21 Mn4Ni1,5CrMo

ER110S-G

## Characteristics and field of use

Medium alloy solid wire electrode for shielded arc welding of quenched and tempered fine grained structural steels. Outstandingly tough weld metal at low temperatures when deposited with gas mixture. Good deformability; outstanding mechanical properties even at higher electric heat input per unit length of weld. Good resistance to cold cracking due to high purity of the wire surface. For use in crane and vehicle manufacturing.

## Base materials

S690QL (aldur 700 QL; alform 700M);  
S700MC (alform 700 M); and higher strength pipe grades (S770QL)

## Typical composition of solid wire (Wt-%)

C	Si	Mn	Cr	Mo	Ni
0,09	0,7	1,7	0,3	0,6	1,85

## Mechanical properties of all-weld metal

Shielding Gas	Yield strength	Tensile strength	Elongation	Impact values	
	0,2%		( $L_0=5d_0$ )	in J CVN	
	MPa	MPa	%	at room temperature	-50°C:
CO <sub>2</sub>	720	770	17	80	
M21	790	880	16	90	47

## Operating data

	Polarity = +	Shielding gas (EN ISO 14175) M2, M3, C1
---	--------------	---

## Dimensions (mm)

1,0	1,2
-----	-----

## Approvals and certificates

DB (Reg. Approvals form No. 42.132.21)

**Classifications**

low-alloyed

EN ISO 16834-A:

AWS A5.28:

G 89 6 M21 Mn4Ni2CrMo

ER120S-G

**Characteristics and field of use**

Copper coated wire electrode for welding high-strength, quenched and tempered fine-grained structural steels with a minimum offset yield strength of 890 MPa.

Thanks to the precise addition of micro-alloying elements, BÖHLER X 90 IG yields a weld metal that features exceptional ductility and high resistance to cracking in spite of its high strength. Good low-temperature impact energy down to -60 °C.

**Base materials**

high-strength, fine-grained structural steels such as S890Q, S890QL, alform plate 900 M x-treme, alform plate 960 M x-treme ASTM A 709 Gr. 100 Type B, E, F, H, Q, HPS 100W

**Typical composition of solid wire (Wt-%)**

C	Si	Mn	Cr	Ni	Mo
0,1	0,8	1,8	0,35	2,25	0,60

**Mechanical properties of all-weld metal**

Heat Treatment	Yield strength 0,2%	Tensile strength	Elongation ( $L_0=5d_0$ )	Impact values in J CVN	
	MPa	MPa	%	+20°C:	-60°C
untreated	915	960	20	130	(≥ 47)

**Operating data**

Polarity = +

 shielding gas:  
Argon + 15-25% CO<sub>2</sub>
**Dimensions (mm)**

1,0	1,2
-----	-----

**Approvals and certificates**

TÜV-D (5611.), DB (42.014.23), GL (6 89S), SEPROZ, CE



# Union X 90

Solid Wire

## Classifications

low-alloyed

EN ISO 16834-A

AWS A5.28

G 89 6 M21 Mn4Ni2CrMo

ER120S-G

## Characteristics and field of use

Medium alloy solid wire electrode for shielded arc welding of quenched and tempered fine grained structural steels. Outstandingly tough weld metal at low temperatures when deposited with gas mixture. Good resistance to cold cracking due to high purity of the wire surface. Used in crane and vehicle manufacture.

## Base materials

S890QL, S960QL (alform 960 M), S890MC (alform 900 M), S960MC (alform 960 M), USS-T1

## Typical composition of solid wire (Wt-%)

C	Si	Mn	Cr	Mo	Ni
0,1	0,8	1,8	0,35	0,6	2,3

## Mechanical properties of all-weld metal

Shielding Gas	Yield strength 0,2%	Tensile strength	Elongation ( $L_0=5d_0$ )	Impact values in J CVN	
	MPa	MPa	%	at room temperature	-60°C:
M21	890	950	15	90	47

## Operating data

	Polarity = +	Shielding gas (EN ISO 14175) M2, M3
---	--------------	-------------------------------------

## Dimensions (mm)

1,0	1,2
-----	-----

## Approvals and certificates

TÜV (Certificate No. 7675), DB (Reg. Approvals form No. 42.132.12)

**Union X 96**

Solid Wire

**Classifications**

low-alloyed

EN ISO 16834-A

AWS A5.28

G 89 5 M21 Mn4Ni2,5CrMo

ER120S-G

**Characteristics and field of use**

Medium alloy solid wire electrode for shielded arc welding of quenched and tempered fine grained structural steels in crane and vehicle manufacturing. Good deformability in spite of very high strength values. Good resistance to cold cracking due to high purity of the wire surface.

**Base materials**

S960QL (alform 960), S890QL, S890MC (alform 900 M) S960MC (alform 960 M)  
OX 1002

**Typical composition of solid wire (Wt-%)**

C	Si	Mn	Cr	Mo	Ni
0,12	0,8	1,9	0,45	0,55	2,35

**Mechanical properties of all-weld metal**

Shielding Gas	Yield strength 0,2%	Tensile strength	Elongation ( $L_0=5d_0$ )	Impact values in J CVN	
				at room temperature	-50°C:
M21	930	980	14	80	47

**Operating data**

Polarity = +

Shielding gas (EN ISO 14175) M2

**Dimensions (mm)**

1,0

1,2

**Approvals and certificates**

DB (Reg. Approvals form No. 42.132.26)

**Classifications**

low-alloyed

EN ISO 21952-A:

AWS A5.28:

G MoSi

ER70S-A1 (ER80S-G)

**Characteristics and field of use**

Solid wire electrode, copper coated for welding in boiler making, pressure vessel and pipeline construction, crane building and steel construction. High-quality, very tough and crack-resistant weld metal, resistant to ageing. Cryogenic down to -40°C. Approved for long-term use at operating temperatures of up to +550°C. The wire electrode has outstanding sliding and feeding characteristics. Good copper adhesion with a low total copper content. Very good welding and flow behaviour.

**Base materials**

creep-resistant steels and cast steels of the same type, steels resistant to ageing and to caustic cracking 16Mo3, 20MnMoNi4-5, 15NiCuMoNb5, S235JR-S355JR, S235JO-S355JO, S450JO, S235J2-S355J2, S275N-S460N, S275M-S460M, P235GH-P355GH, P355N, P285NHP460NH, P195TR1-P265TR1, P195TR2-P265TR2, P195GH-P265GH, L245NB-L415NB, L450QB, L245MB-L450MB, GE200-GE300 ASTM A 29 Gr. 1013, 1016; A 106 Gr. C; A, B; A 182 Gr. F1; A 234 Gr. WP1; A 283 Gr. B, C, D; A 335 Gr. P1; A 501 Gr. B; A 533 Gr. B, C; A 510 Gr. 1013; A 512 Gr. 1021, 1026; A 513 Gr. 1021, 1026; A 516 Gr. 70; A 633 Gr. C; A 678 Gr. B; A 709 Gr. 36, 50; A 711 Gr. 1013; API 5 L B, X42, X52, X60, X65

**Typical composition of solid wire (Wt-%)**

C	Si	Mn	Mo			
0,1	0,6	1,1	0,5			

**Mechanical properties of all-weld metal**

Heat Treatment	Yield strength 0,2%	Tensile strength	Elongation (L <sub>0</sub> =5d <sub>0</sub> )	Impact values in J CVN	
				+20°C:	-40°C
untreated *	500	600	25	150	(≥ 47)
untreated 1**	470	590	23	150	(≥ 47)
annealed ***	450	570	25	150	

\* untreated, as-welded - shielding gas Ar + 18% CO<sub>2</sub> \*\* untreated, as-welded - shielding gas 100% CO<sub>2</sub>

\*\*\* annealed, 620°C/1 h/furnace down to 300°C/air - shielding gas Ar + 18% CO<sub>2</sub>

**Operating data**

	Polarity = +	Argon + 15-25% CO <sub>2</sub> 100% CO <sub>2</sub>
---	--------------	--

**Dimensions (mm)**

0,8	1,0	1,2	
-----	-----	-----	--

**Approvals and certificates**

TÜV-D (0021.), DB (42.014.09), CL (0216), SEPROZ, CE, NAKS

**Similar alloy filler metals**

SMAW electrode: FOX DMO Kb, FOX DMO Ti	GTAW rod: DMO-IG	Flu cored wire: DMO Ti-FD	SAW wire: EMS 2 Mo
---	---------------------	------------------------------	-----------------------

# Union I Mo

Solid Wire

## Classifications

low-alloyed

EN ISO 21952-A:

AWS A5.28

G MoSi

ER80S-G(A1)

## Characteristics and field of use

GMAW solid wire electrode for the welding of low alloy and creep resistant steels. All-purpose, medium-alloyed solid wire electrode, useable both with CO<sub>2</sub> and with gas mixture. Applications include the welding of low alloyed and creep resistant steels in boiler, tank, pipeline and reactor construction.

## Base materials

P235GH, P265GH, P295GH, 16 Mo 3; fine grained structural steels up to S460N; pipe steels according to DIN 17 175; ASTM A335 Gr. P1; A161-94 Gr. T1 A; A182M Gr. F1; A204M Gr. A, B, C; A250M Gr. T1; A217 Gr. WC1

## Typical composition of solid wire (Wt-%)

C	Si	Mn	Mo		
0,1	0,6	1,15	0,5		

## Mechanical properties of all-weld metal

Shielding Gas	Yield strength 0,2%	Tensile strength	Elongation (L <sub>0</sub> =5d <sub>0</sub> )	Impact values in J CVN	
	MPa	MPa	%	at room temperature	-50°C:
CO <sub>2</sub>	450	550	24	80	
M21	490	600	23	90	47

## Operating data

	Polarity = +	Shielding gas (EN ISO 14175) M1- M3 and C1
---	--------------	--

## Dimensions (mm)

0,8	1,0	1,2	
-----	-----	-----	--

## Approvals and certificates

TÜV (Certificate No. 1831) DB (Reg. Approvals form No. 42.132.14)

## Classifications

low-alloyed

EN ISO 21952-A:

AWS A5.28:

G CrMo1Si

ER80S-G

## Characteristics and field of use

Solid wire electrode, copper coated for welding in boiler, pressure vessel and pipeline construction, also for welding work with quenched and tempered and case-hardening steels. Preferred for 13CrMo4-5. Approved for long-term use at operating temperatures of up to +570°C. The weld metal exhibits high quality, good toughness and crack resistance; it is resistant to caustic cracking, can be nitrated and is suitable for quenching and tempering. The creep strength is in the same range as the 13CrMo4-5 material. The wire electrode has very good sliding and feeding characteristics. Good copper adhesion, low total copper content. Very good welding and flow behaviour.

## Base materials

same alloy creep resistant steels and cast steel, case-hardening and nitriding steels with comparable composition, heat treatable steels with comparable composition, steels resistant to caustic cracking 1.7335 13CrMo4-5, 1.7262 15CrMo5, 1.7728 16CrMoV4, 1.7218 25CrMo4, 1.7225 42CrMo4, 1.7258 24CrMo5, 1.7354 G22CrMo5-4, 1.7357 G17CrMo5-5 ASTM A 182 Gr. F12; A 193 Gr. B7; A 213 Gr. T12; A 217 Gr. WC6; A 234 Gr. WP11; A335 Gr. P11, P12; A 336 Gr. F11, F12; A 426 Gr. CP12

## Typical composition of solid wire (Wt-%)

C	Si	Mn	Cr	Mo		
0,11	0,6	1,0	1,2	0,5		

## Mechanical properties of all-weld metal

Heat Treatment	Yield strength 0,2%	Tensile strength	Elongation ( $L_0=5d_0$ )	Impact values in J CVN
	MPa	MPa	%	+20°C:
annealed*	440	570	23	140

\* 680°C/2h/Ofen bis 300°C/Luft – Schutzgas Ar + 18% CO<sub>2</sub>

## Operating data

	Polarity = +	Argon + 15-25% CO <sub>2</sub> 100% CO <sub>2</sub>
---	--------------	--

## Dimensions (mm)

0,8	1,0	1,2	1,6
-----	-----	-----	-----

## Approvals and certificates

TÜV-D (1091), DB (42.014.15), SEPROZ, CE

## Similar alloy filler metals

SMAW electrode:	FOX DCMS Kb FOX DCMS Ti	SAW combination:	EMS 2 CrMo/BB 24 EMS 2 CrMo/BB 418 TT
GTAW rod:	DCMS-IG	Gas welding rod:	DCMS
Flux cored wire:	DCMS Ti-FD		

**Union I CrMo**

Solid Wire

Classifications		low-alloyed	
EN ISO 21952-A		AWS A5.28	
G CrMo1Si		ER80S-G	

**Characteristics and field of use**

Medium alloy solid wire useable both with CO<sub>2</sub> and mixed gas. Applications include the welding of creep resistant steels in boiler, tank, pipeline and reactor construction.

**Base materials**

1.7335 – 13CrMo4-5; ASTM A193 Gr. B7; A335 Gr. P11 und P12; 1.7357 – G17CrMo5-5 – A217 Gr. WC6

**Typical composition of solid wire (Wt-%)**

C	Si	Mn	Cr	Mo	
0,09	0,6	1,05	1,1	0,5	

**Mechanical properties of all-weld metal**

Shielding Gas	Yield strength 0,2%	Tensile strength	Elongation (L <sub>0</sub> =5d <sub>0</sub> )	Impact values in J CVN
	MPa	MPa	%	impact RT
M21	450	560	22	80

**Operating data**

	Polarity = +	
---	--------------	--

**Dimensions (mm)**

0,8	1,0	1,2	1,6
-----	-----	-----	-----

**Approvals and certificates**

TÜV (Certificate Nr. 905), DB (Reg. form No. 42.132.19)

## Classifications

low-alloyed

EN ISO 21952-A:

AWS A5.28:

G CrMo2Si

ER90S-B3 (mod.)

## Characteristics and field of use

Solid wire electrode, copper coated for welding in boiler, pressure vessel and pipeline construction, and for the petrochemical industry, e.g. cracking plants. Preferred for 10CrMo9-10, and also suitable for similar-alloy quenched and tempered and case-hardening steels. Approved for long-term use at operating temperatures of up to +600°C. The weld metal exhibits high quality, good toughness and crack resistance, as well as a creep strength very much in the same range as 10CrMo9-10. The wire electrode has very good sliding and feeding characteristics. Good copper adhesion, low total copper content. Very good welding and flow behaviour.

## Base materials

same type as creep-resistant steels and cast steels, similar alloy quenched and tempered steels up to 980 MPa strength, similar alloy case-hardening and nitriding steels  
 1.7380 10CrMo9-10, 1.7276 10CrMo11, 1.7281 16CrMo9-3, 1.7383 11CrMo9-10,  
 1.7379 G17CrMo9-10, 1.7382 G19CrMo9-10 ASTM A 182 Gr. F22; A 213 Gr. T22; A 234 Gr. WP22;  
 335 Gr. P22; A 336 Gr. F22; A 426 Gr. CP22

## Typical composition of solid wire (Wt-%)

C	Si	Mn	Cr	Mo		
0,08	0,6	0,95	2,6	1,0		

## Mechanical properties of all-weld metal

Heat Treatment	Yield strength 0,2%	Tensile strength	Elongation ( $L_0=5d_0$ )	Impact values in J CVN
	MPa	MPa	%	+20°C:
annealed*	440	580	23	170

\* 720°C/2h/ Ofen bis 300°C/ Luft – Schutzgas Ar + 18% CO<sub>2</sub>

## Operating data

	Polarity = +	Argon + 15-25% CO <sub>2</sub> 100% CO <sub>2</sub>
--	--------------	--

## Dimensions (mm)

0,8	1,0	1,2	
-----	-----	-----	--

## Approvals and certificates

TÜV-D (1085.), DB (42.014.39), SEPROZ, CE

## Similar alloy filler metals

SMAW electrode:	FOX CM 2 Kb FOX CM 2 Kb SC	SAW combination:	CM 2-UP/BB 24
GTAW rod:	CM 2-IG		CM 2 SC-UP/BB 24 SC
Flux cored wire:	CM 2 Ti-FD		CM 2-UP/BB 418 TT

**BÖHLER C 9 MV-I**

Solid Wire

<b>Classifications</b>	low-alloyed	
EN ISO 21952-A:	AWS A5.28:	
G CrMo91	ER90S-B9	

**Characteristics and field of use**

Solid wire electrode for highly creep resistant, quenched and tempered 9-12% chrome steels, particularly for T91/P91 steels in turbine and boiler construction and in the chemical industry. BÖHLER C 9 MV-IG can be employed for long-term operating temperatures of up to +650°C.

**Base materials**

same type as highly creep resistant steels 1.4903 X10CrMoVNb9-1, GX12CrMoVNbN9-1  
ASTM A 335 Gr. P91, A 336 Gr. F91, A 369 Gr. FP91, A 387 Gr. 91, A 213 Gr. T91

**Typical composition of solid wire (Wt-%)**

C	Si	Mn	Cr	Ni	Mo	V	Nb
0,12	0,3	0,5	9,0	0,5	0,9	0,2	0,06

**Mechanical properties of all-weld metal**

Heat Treatment	Yield strength 0,2%	Tensile strength	Elongation ( $L_0=5d_0$ )	Impact values in J CVN
	MPa	MPa	%	+20°C:
annealed*	620	760	18	80

\* 760°C/2 h/Ofen bis 300°C/Luft – Schutzgas Argon + 2.5% CO2

**Operating data**

	Polarity = +	shielding gas : Argon + 2.5% CO2
---	--------------	-------------------------------------

**Dimensions (mm)**

0,8	1,0	1,2	1,6
-----	-----	-----	-----

**Similar alloy filler metals**

SMAW electrode:	FOX C 9 MV	SAW combination:	C 9 MV-UP/BB 910
GTAW rod:	C 9 MV-IG		



# Thermanit MTS 3

Solid Wire

## Classifications

low-alloyed

EN ISO 21952-A:

AWS A5.28:

G CrMo91

ER90S-B9

## Characteristics and field of use

High temperature resistant, resistant to scaling up to 600 °C (1112 °F). Suited for joining and surfacing applications with quenched and tempered 9% Cr steels, particularly for matching high temperature resistant parent metal T91 / P91 according to ASTM.

## Base materials

1.4903 – X10CrMoVNb9-1; ASTM A 199 Gr. T91, A213/213M Gr. T91, A355 Gr. P91 (T91)

## Typical composition of solid wire (Wt-%)

C	Si	Mn	Cr	Mo	Ni	Nb	others
0,1	0,3	0,5	9,0	1,0	0,7	0,06	0,2

## Mechanical properties of all-weld metal

Heat Treatment	Yield strength 0,2%	Tensile strength	Elongation ( $L_0=5d_0$ )	Impact values in J CVN
	MPa	MPa	%	+20°C:
760 C / 2 h	520	620	16	50

## Operating data

	Polarity =+	Shielding gas (EN ISO 14175) M12, (M13)
---	-------------	---

## Dimensions (mm)

1,0	1,2		
-----	-----	--	--

# Union I CrMo 910

Solid Wire

## Classifications

low-alloyed

EN ISO 21952-A:

AWS A5.28:

G CrMo2Si

ER90S-G

## Characteristics and field of use

Medium alloy solid wire electrode for gas-shielded arc welding both with gas mixture and CO<sub>2</sub>. Applications include the welding of creep resistant steels in boiler, tank, pipeline and reactor construction.

## Base materials

1.7380 – 10CrMo9-10; ASTM A335 Gr. P22; 1.7379 – G17CrMo9-10 – A217 Gr. WC9

## Typical composition of solid wire (Wt-%)

C	Si	Mn	Cr	Mo		
0,09	0,55	0,9	2,55	1,0		

## Mechanical properties of all-weld metal

	Yield strength 0,2%	Tensile strength	Elongation (L <sub>0</sub> =5d <sub>0</sub> )	Impact values in J CVN
Shielding Gas	MPa	MPa	%	at room temperature
M21	640	570	20	65

\*) Also weldable with CO<sub>2</sub>. in this case the mechanical properties will change.

## Operating data

	Polarity = +	Shielding gas (EN ISO 14175) M1- M3 and C1
---	--------------	--

## Dimensions (mm)

1,0	1,2		
-----	-----	--	--

## Approvals and certificates

TÜV (Certificate No. 0907), DB (Reg. Approvals form No. 42.132.06)

Classifications		low-alloyed
EN ISO 21952-A:		AWS A5.28:
GZ CrMoWVNb 9 0,5 1,5		ER90S-G

### Characteristics and field of use

High temperature resistant. Suited for joining and surfacing applications with matching high temperature resistant parent metal P92 according to ASTM A 335.

### Base materials

ASTMA 355 Gr. P92, NF 616, ASTM A 355 Gr. P92 (T92); A213 Gr. 92, 1.4901 – X10CrWMoVNb9-2

### Typical composition of solid wire (Wt-%)

C	Si	Mn	Cr	Mo	Ni	W	V	Nb	N
0,1	0,25	0,5	8,5	0,4	0,5	1,6	0,2	0,06	0,04

### Mechanical properties of all-weld metal

Heat Treatment	Yield strength 0,2%	Tensile strength	Elongation ( $L_0=5d_0$ )	Impact values in J CVN
	MPa	MPa	%	+20°C:
760°C/≥2 h	560	720	15	41

### Operating data

	Polarity = +	Shielding gas (EN ISO 14175) M12, (M13)
---	--------------	---

### Dimensions (mm)

0,8	1,0	1,2	1,6
-----	-----	-----	-----

### Approvals and certificates

TÜV (Certificate No. 9290)

# Thermanit ATS 4

Solid Wire

## Classifications

low-alloyed

EN ISO 21952-A:

AWS A5.28:

G19 9 H

ER19-10 H

## Characteristics and field of use

High temperature resistant up to 700 °C (1292 °F); resistant to scaling up to 800 °C (1472 °F). For surfacing and joining applications on matching/similar high temperature resistant steels/cast steel grades.

## Base materials

1.4550 – X6CrNiNb18-10 1.4948 – X6CrNi18-1 1.4878 – X12CrNiTi18-9 AISI 304H; 321H; 347H

## Typical composition of solid wire (Wt-%)

C	Si	Mn	Cr	Ni		
0,05	0,3	1,8	18,8	9,3		

## Mechanical properties of all-weld metal

Heat Treatment	Yield strength 0,2%	Tensile strength	Elongation ( $L_0=5d_0$ )	Impact values in J CVN
	MPa	MPa	%	at room temperature
AW	350	550	35	70

## Operating data

	Polarity = +	Shielding gas (EN ISO 14175) M12
---	--------------	----------------------------------

## Dimensions (mm)

1,0	1,2		
-----	-----	--	--

## Approvals and certificates

TÜV (Certificate No. 6522)

# Union K 5 Ni

Solid Wire

## Classifications

low-alloyed

EN ISO 14341-A

AWS A5.28:

G 50 5 M21 3Ni1/G 46 3 C1 3Ni1

ER80S-G

## Characteristics and field of use

Ni alloyed solid wire electrode for gas-shielded arc welding of cryogenic fine grained structural steels. Shielding gases: Gas mixture and CO<sub>2</sub>. Extremely metallurgically pure weld metal with good low temperature toughness when deposited in combination with gas mixtures.

## Base materials

S355NL - S500QL cryogenic special structural steels 15 MnNi 63

## Typical composition of solid wire (Wt-%)

C	Si	Mn	Ni			
0,1	0,7	1,4	1,4			

## Mechanical properties of all-weld metal

Shielding Gas	Yield strength 0,2%	Tensile strength	Elongation (L <sub>0</sub> =5d <sub>0</sub> )	Impact values in J CVN		
	MPa	MPa	%	+20°C:	-30°C	-50°C
M21	500	590	24	130		47
CO <sub>2</sub>	460	560	24	110	47	

## Operating data



Polarity = +

Shielding gas (EN ISO 14175) M1- M3 and C1

## Dimensions (mm)

1,0	1,2		
-----	-----	--	--

## Approvals and certificates

TÜV (Certificate No. 514), DB (Reg. Approvals form No. 42.132.13)

<b>Classifications</b>	low-alloyed	
EN ISO 14341-A:	AWS A5.28:	
G 42 5 M21 3Ni1	ER80S-G	

**Characteristics and field of use**

BÖHLER SG 8-P is a micro-alloyed wire for automated, gas shielded arc welding of pipelines. The precise addition of micro-alloying elements yields a weld metal that features excellent low-temperature impact energy down to -50 °C, along with exceptional ductility and high resistance to cracking. Further quality features of this wire include exceptional welding and flow properties, along with ideal feeding characteristics. Further applications are found in steel, container and apparatus construction.

**Base materials**

API5L: X42 – X60 EN 10208-2: L290MB-L415MB

**Typical composition of solid wire (Wt-%)**

C	Si	Mn	Ni	Ti		
0,06	0,7	1,5	0,9	+		

**Mechanical properties of all-weld metal**

Heat Treatment	Yield strength 0,2%	Tensile strength	Elongation (L <sub>0</sub> =5d <sub>0</sub> )	Impact values in J CVN	
				+20°C:	-50°C:
untreated *	500	590	24	150	80
untreated 1 **	470	560	25	110	45

\* untreated, as-welded - shielding gas: Ar +15-25% CO2

\*\* untreated, as-welded - shielding gas: 100% CO2

**Operating data**

	Polarity = +	Shielding gas: Argon + 15-25% CO2 Argon + 0-5% CO2 + 3-10% O2 100% CO2
--	--------------	--

**Dimensions (mm)**

0,9	1,0	1,2	
-----	-----	-----	--

**Approvals and certificates**

DNV (IV 46 MS)

## Classifications

low-alloyed

EN ISO 14341-A:

AWS A5.28:

G 46 8 M21 2Ni2

ER80S-Ni2

## Characteristics and field of use

2.5% Ni alloy wire electrode, copper coated, for gas shielded arc welding of cryogenic fine-grained construction steels and nickel-alloy steels. For high-quality welding on storage tanks and pipe systems for low-temperature applications. Applicable, depending on the shielding gas used, down to -80 C.

## Base materials

cryogenic structural and Ni-alloy steels, special cryogenic shipbuilding steels.  
 10Ni14, 12Ni14, 13MnNi6-3, 15NiMn6, S275N-S460N, S275NL-S460NL, S275M-S460M, S275ML-S460ML, P275NL1-P460NL1, P275NL2-P460NL2 ASTM A 203 Gr. D, E; A 333 Gr. 3; A334 Gr. 3; A 350 Gr. LF1, LF2, LF3; A 420 Gr. WPL3, WPL6; A 516 Gr. 60, 65; AA 529 Gr. 50; A 572 Gr. 42, 65; A 633 Gr. A, D, E; A 662 Gr. A, B, C; A 707 Gr. L1, L2, L3; A 738 Gr. A; A 841 A, B, C

## Typical composition of solid wire (Wt-%)

C	Si	Mn	Ni			
0,08	0,6	1,0	2,4			

## Mechanical properties of all-weld metal

Heat Treatment	Yield strength 0,2%	Tensile strength	Elongation ( $L_0=5d_0$ )	Impact values in J CVN		
	MPa	MPa	%	+20°C:	-60°C:	-80°C:
untreated *	510	600	22	170		(≥ 47)
untreated 1 **	500	590	22	120	(≥ 47)	

\* untreated, as-welded - shielding gas: Ar +15-25% CO2

\*\* untreated, as-welded - shielding gas: 100% CO2

## Operating data

	Polarity = +	Shielding gas: Argon + 15-25% CO2 100% CO2
--	--------------	---

## Dimensions (mm)

0,8	1,0	1,2	
-----	-----	-----	--

## Approvals and certificates

TÜV-D (01080.), DB (42.014.16), ABS (X Q460X-5), BV (SA 3 M; UP), DNV (5 MS), GL (6 38S), LR (5 40S H15), SEPROZ, CE

## Similar alloy filler metals

SMAW electrode:	FOX 2.5 Ni	SAW combination:	Ni 2-UP/BB 24, Ni 2-UP/BB 421 TT
GTAW rod:	2.5 Ni-IG		

# Union K 52 Ni

Solid Wire

## Classifications

low-alloyed

EN ISO 14341-A

AWS A5.28:

G 50 6 M21 Z3Ni1/G 46 4 C1 Z3Ni1

ER80S-G ER80S-Ni1(mod.)

## Characteristics and field of use

Ni alloyed solid wire for GMAW welding of cryogenic fine grained steels down to -60°C, for fine grained steels up to S500.

## Base materials

EN 10028-3 P355NL2 – P460NL2

EN 10025-6 S500QL1

API5L: X 42 – X 70 (X 80)

EN 120208-2: L290MB – L485MB

EN 10149-2 S355MC – S500MC

## Typical composition of solid wire (Wt-%)

C	Si	Mn	Ni	Mo		
0,06	0,7	1,5	0,9	0,08		

## Mechanical properties of all-weld metal

Shielding Gas	Yield strength 0,2%	Tensile strength	Elongation ( $L_0=5d_0$ )	Impact values in J CVN		
	MPa	MPa	%	+20°C:	-40°C	-60°C
M21	500	590	24	150		47
CO <sub>2</sub>	460	560	24	140	47	

## Operating data



Polarity = +

## Dimensions (mm)

1,0	1,2		
-----	-----	--	--

## Approvals and certificates

ABS, DNV



# Union K Nova Ni

Solid Wire

## Classifications

low-alloyed

EN ISO 14341-A

AWS A5.28:

G 42 5 M21 3Ni1

ER80S-G

## Characteristics and field of use

micro-alloyed wire for automated, gas shielded arc welding. The precise addition of micro-alloying elements yields a weld metal that features excellent lowtemperature impact energy down to -50°C, along with exceptional ductility and high resistance to cracking. Further quality features of this wire include exceptional welding and flow properties, along with ideal feeding characteristics. Applications are found in steel, container and apparatus construction.

## Base materials

API5L: X42 – X60 EN 10208-2: L290MB-L415MB

## Typical composition of solid wire (Wt-%)

C	Si	Mn	Ni	Ti		
0,06	0,7	1,5	0,9	+		

## Mechanical properties of all-weld metal

Shielding Gas	Yield strength	Tensile strength	Elongation	Impact values	
	0,2%		( $L_0=5d_0$ )	in J CVN	
	MPa	MPa	%	+20°C:	-50°C
M21	500	590	24	150	80
CO <sub>2</sub>	470	560	25	110	45

## Operating data



Polarity = +

Shielding gas (EN ISO 14175) M1- M3 and C1

## Dimensions (mm)

1,0	1,2		
-----	-----	--	--

**Union Ni 2,5**

Solid Wire

**Classifications**

low-alloyed

EN ISO 14341-A

AWS A5.28:

G 50 7 M21 2Ni2

ER80S-Ni2

**Characteristics and field of use**

Medium alloy solid wire electrode for shielded arc welding of cryogenic fine grained structural steels. Outstanding toughness values at low temperatures when deposited in combination with gas mixture.

**Base materials**

12Ni14G1, X12Ni5

P-, S275NL2 - P-, S500QL1; 13 MnNi 6-3; ASTM A633 Gr. E;

A572 Gr. 65; A203 Gr. D; A333 and A334 Gr. 3; A350 Gr. LF3

**Typical composition of solid wire (Wt-%)**

C	Si	Mn	Ni			
0,08	0,6	1,0	2,35			

**Mechanical properties of all-weld metal**

Shielding Gas	Yield strength 0,2%	Tensile strength	Elongation ( $L_0=5d_0$ )	Impact values in J CVN		
	MPa	MPa	%	+20°C:	-70°C	-80°C
M21	510	620	24	120	47	
M21 (SR)*	450	560	24	140		47

\*SR (560 C (1040 F) – 4 h)

**Operating data**

Polarity = +

Shielding gas (EN ISO 14175) M1, M2

**Dimensions (mm)**

1,0	1,2		
-----	-----	--	--

**Approvals and certificates**

TÜV (Certificate No. 1627), ABS, GL (7YS), LR, BV, DNV



## Chapter 3.2 - (GMAW) Solid wire (high-alloyed)

Product name	EN ISO	AWS	Page
Avesta 307-Si	G 18 8 Mn	ER307 (mod.)	2
BOHLER A 7-IG / A 7 CN-IG	G 18 8 Mn	ER307 (mod.)	3
Thermanit X	G 18 8 Mn	ER307 (mod.)	4
Avesta 308L-Si/MVR-Si	G 19 9 L Si	ER308LSi	5
BOHLER EAS 2-IG (Si)	G 19 9 L Si	ER308LSi	6
Thermanit JE-308L Si	G 19 9 L Si	ER308LSi	7
Avesta 309L-Si	G 23 12 L Si	ER309LSi	8
BOHLER CN 23/12-IG	G 23 12 L	ER309L	9
Thermanit 25/14 E-309L Si	G 23 12 L Si	ER309LSi	10
BOHLER FF-IG	G 22 12 H	ER309 (mod.)	11
Thermanit D	G 22 12 H	ER309 (mod.)	12
Avesta 316L-Si/SKR-Si	G 19 12 3 L Si	ER316LSi	13
BOHLER EAS 4 M-IG (Si)	G 19 12 3 L Si	ER316LSi	14
Thermanit GE-316L Si	G 19 12 3 L Si	ER316LSi	15
Avesta 318-Si/SKNb-Si	G 19 12 3 Nb Si	-	16
BOHLER ASN 5-IG (Si)	G 218 16 5 N L	ER317L (mod.)	17
Thermanit A Si	G 19 12 3 Nb Si	ER318 (mod.)	18
BOHLER SAS 2-IG (Si)	G 19 9 Nb Si	ER347Si	19
Thermanit H Si	G 19 9 Nb Si	ER347Si	20
BOHLER CN 13/4-IG	G 13 4	ER410NiMo (mod.)	21
Avesta 2205	G 22 9 3 N L	ER2209	22
BOHLER CN 22/9 N-IG	G 22 9 3 NL	ER2209	23
Thermanit 22/09	G 22 9 3 N L	ER2209	24
Avesta LDX 2101	G 23 7 N L	-	25
Avesta P5	G 23 12 2 L	-	26
Avesta 2507/P100	G 25 9 4 N L	-	27
Thermanit 25/09 CuT	G 25 9 4 N L	ER2594	28
BOHLER FA-IG	G 25 4	-	29
Thermanit L	G 25 4	-	30
BOHLER FFB-IG	G 25 20 Mn	ER310 (mod.)	31
BOHLER SKWAM-IG	G Z 17 Mo	-	32
Thermanit 17/15 TT	G Z 17 15 Mn W	-	33
BOHLER CAT 430L Cb-IG	G Z 18 L Nb	ER430 (mod.)	34
BOHLER CAT 430L CbTi-IG	G Z Cr 18 Nb Ti L	ER430Nb (mod.)	35
Thermanit 439 Ti	G Z 18 Ti L	ER439 (mod.)	36
UTP A 2133 Mn	G Z 21 33 Mn Nb	-	37
UTP A 2535 Nb	G Z 25 35 Zr	-	38
Avesta P12	S Ni 6625 (NiCr22Mo9Nb)	ERNiCrMo-3	39
BOHLER NiBAS 625-IG	S Ni 6625 (NiCr22Mo9Nb)	ERNiCrMo-3	40
Thermanit 625	S Ni 6625 (NiCr22Mo9Nb)	ERNiCrMo-3	41
UTP A 6222 Mo	S Ni 6625 (NiCr22Mo9Nb)	ERNiCrMo-3	42
BOHLER NiBAS 70/20-IG	S Ni 6082 (NiCr20Mn3Nb)	ERNiCr-3	43
Thermanit Nicro 82	S Ni 6082 (NiCr20Mn3Nb)	ERNiCr-3	44
UTP A 068 HH	S Ni 6082 (NiCr20Mn3Nb)	ERNiCr-3	45
Thermanit 617	S Ni 6617 (NiCr22Co12Mo9)	ERNiCrCoMo-1	46
UTP A 6170 Co	S Ni 6617 (NiCr22Co12Mo9)	ERNiCrCoMo-1	47
UTP A 776	S Ni 6276 (NiCr15Mo16Fe6W4)	ERNiCrMo-4	48
Thermanit NiMo C 24	S Ni 6059 (NiCr23Mo16)	ERNiCrMo-13	49
UTP A 759	S Ni 6059 (NiCr23Mo16)	ERNiCrMo-13	50
UTP A 80 M	S Ni 4060 (NiCu30Mn3Ti)	ERNiCu-7	51
Thermanit 35/45 Nb	S Ni Z (NiCr36Fe15Nb0.8)	-	52
UTP A 3545 Nb	G Z 35 45 Nb	-	53

<b>Classifications</b>	high-alloyed	
EN ISO 14343	AWS A5.9:	
G 18 8 Mn	ER307 (mod.)	

**Characteristics and field of use**

Avesta 307-Si is a high-alloy, fully austenitic wire designed for welding dissimilar joints between stainless and mild or low-alloy steels, as well as Mn-steels. It can also be used for welding steels like Armox®, Hardox®, durostat®, Weldox® and alform®. Avesta 307-Si offers a crack resistant weld with good mechanical properties.  
 Corrosion resistance:  
 Primarily intended for stainless to mild steel connections but with the same corrosion resistance as 1.4301/ASTM 304.

**Base materials**

For welding steels such as					
Outokumpu	EN	ASTM	BS	NF	SS
Avesta 307-Si is primarily used in dissimilar welding between stainless and mild steel or low-alloy steels.					

2

**Typical composition of solid wire (Wt-%)**

C	Si	Mn	Cr	Ni	Mo
0,08	0,8	6,8	19,0	8,0	0,1

Ferrite 0 FN

**Mechanical properties of all-weld metal**

Heat Treatment	Yield strength 0,2%	Tensile strength	Elongation (L <sub>0</sub> =5d <sub>0</sub> )	Impact values in J CVN	
	MPa	MPa	%	+20°C:	-40°C:
untreated	410	630	38	120	110

**Operating data**

	Polarity = +	Shielding gas Ar + 2 % O <sub>2</sub> or 2–3 % CO <sub>2</sub> Gas flow rate 12 – 16 l/min.
---	--------------	---

**Dimensions (mm)**

0,8	1,0	1,2	1,6	
-----	-----	-----	-----	--

<b>Classifications</b>	high-alloyed		
EN ISO 14343-A:	AWS A5.9:		
G 18 8 Mn	ER307 (mod.)		

**Characteristics and field of use**

Solid wire electrode for joints between dissimilar steels, steels that are hard to weld and 14% Mn steels. Well suited for tough intermediate layers in case of hardfacing. Wear-resistant and corrosion-resistant surfacings on rail and points components, valve seats and cavitation protection armour in hydroelectric machines. Properties of the weld metal: suitable for strain-hardening, very good cavitation resistance, crack resistant, resistant to thermal shock, resistant to scaling up to +850 °C, little tendency to sigma-phase embrittlement above +500 °C. Cryogenic down to -110 °C. Heat treatment is possible. Consultation with the manufacturer is recommended for operating temperatures above +650°C. Outstanding sliding and feeding characteristics. Very good welding and flow behaviour. It is approved for welding armour plates.

**Base materials**

High-strength, unalloyed and alloyed structural and quenched and tempered steels among themselves or among each other; unalloyed and alloyed steels with high-alloy Cr and CrNi steels; heat-resistant steels up to +850 °C; austenitic manganese steels together and with other steels; cryogenic plate and pipe steels together with cryogenic austenitic materials

**Typical composition of solid wire (Wt-%)**

C	Si	Mn	Cr	Ni
0,08	0,9	7,0	19,2	9,0

**Typical composition of solid wire (Wt-%)**

Heat Treatment	Yield strength 0,2%	Tensile strength	Elongation ( $L_0=5d_0$ )	Impact values in J CVN
	MPa	MPa	%	+20°C:
untreated	430	640	36	110

**Operating data**

	Polarity = +	shielding gas: Argon + max. 2.5% CO <sub>2</sub>
--	--------------	---

**Dimensions (mm)**

0,8	1,0	1,2	1,6
-----	-----	-----	-----

**Approvals and certificates**

TÜV-D (06632), DB (43.014.13), DB (43.014.07), SEPROZ, VG 95132, CE, NAKS (Ø 0.8; 1.0 mm), DNV (X), GL (4370S), (A 7 CN-IG: TÜV-D (00024.))

**Similar Allo Filler Metals**

SMAW electrode:	FOX A 7 / FOX A 7 CN* FOX A 7-A	Flu cored wire:	A 7-MC, A 7-FD, A 7 PW-FD
GTAW solid wire:	A 7-IG / A 7 CN-IG*	SAW combination:	A 7 CN-UP/BB 203

# Thermanit X

Solid Wire

<b>Classifications</b>		high-alloyed
EN ISO 14343-A:	AWS A5.9:	
G 18 8 Mn	ER307 (mod.)	

## Characteristics and field of use

Stainless. Resistant to scaling up to 850 °C (1562 °F). No adequate resistance against sulphurous combustion gases at temperatures above 500 °C (932 °F). For joining and surfacing applications with heat resistant Cr-steels/cast steel grades and heat resistant austenitic steels/cast steel grades. Well suited for fabricating austenitic-ferritic joints – max. application temperature 300 °C (572 °F). For joining unalloyed/low-alloy or Cr-steels/ cast steel grades to austenitic steels. Low heat input required in order to avoid brittle martensitic transition zones.

## Base materials

TÜV-certified parent metal 1.4583 – X10CrNiMoNb18-12 and included parent metals combined with ferritic steels up to boiler plate P295GH. High tensile, unalloyed and alloyed structural, quenched and tempered, and armour steels, same parent metal or in combination; unalloyed and alloyed boiler or structural steels with high alloyed Cr and CrNi steels; heat resistant steels up to 850 °C (1562 °F); austenitic high manganese steel with matching and other steels. Cryogenic sheet metals and pipe steels in combination with austenitic parent metals.

## Typical composition of solid wire (Wt-%)

C	Si	Mn	Cr	Ni
0,08	0,8	7,0	19,0	9,0

## Mechanical properties of all-weld metal

Heat Treatment	Yield strength 0,2%	Tensile strength	Elongation ( $L_0=5d_0$ )	Impact values in J CVN
	MPa	MPa	%	at RT
untreated	370	600	35	100

## Operating data

	Polarity = +	Shielding gas (EN ISO 14175) M12,M13, M21
--	--------------	---

## Dimensions (mm)

0,8	1,0	1,2	1,6		
-----	-----	-----	-----	--	--

## Approvals and certificates

TÜV (Certificate No. 5651), GL (4370 S), DB (Reg. form No. 43.132.01), DNV

A 0 L- MVR- Solid Wire

<b>Classifications</b>	high-alloyed	
EN ISO 14343-A:	AWS A5.9:	
G 19 9 L Si	ER308LSi	

Characteristics and field of use

Avesta 308L-Si/MVR-Si is designed for welding 1.4301/ASTM 304 type stainless steels. It can also be used for welding steels that are stabilised with titanium or niobium, such as 1.4541/ASTM 321 and 1.4550/ASTM 347 in cases where the construction will be operating at temperatures below 400 C. For higher temperatures a niobium stabilized consumable such as Avesta 347-Si/MVNb-Si is required.

**Corrosion resistance**

Very good under fairly severe conditions, e.g. in oxidising acids and cold or dilute reducing acids.

Base materials

For welding steels such as					
Outokumpu	EN	ASTM	BS	NF	SS
4301	1.4301	304	304S31	Z7 CN 18-09	2333
4307	1.4307	304L	304S11	Z3 CN 18-10	2352
4311	1.4311	304LN	304S61	Z3 CN 18-10 Az	2371
4541	1.4541	321	321S31	Z6 CNT 18-10	2337

Typical composition of solid wire (Wt-%)

C	Si	Mn	Cr	Ni
0,02	0,85	1,8	20,0	10,5

Ferrite 8 FN; WRC-92

Mechanical properties of all-weld metal

Heat Treatment	Yield strength	Tensile strength	Elongation (L <sub>0</sub> =5d <sub>0</sub> )	Impact values in J CVN	
	0,2%			+20°C:	-196°C:
	MPa	MPa	%		
untreated	410	590	36	110	60

Operating data

	Polarity = +	Shielding gas Ar + 2 % O <sub>2</sub> or 2–3 % CO <sub>2</sub> Gas flow rate 12–16 l/min.
---	--------------	---

Dimensions (mm)

0,8	1,0	1,2	1,6
-----	-----	-----	-----



**Classifications**

high-alloyed

EN ISO 14343-A:

AWS A5.9:

G 19 9 L Si

ER308LSi

**Characteristics and field of use**

Solid wire electrode for application in all branches of industry in which same-type steels and ferritic 13% chrome steels are welded, e.g. the construction of chemical apparatus and containers, the textile and cellulose industry, dye works and many more. Outstanding sliding and feeding characteristics. Very good welding and flow behaviour. Resists intergranular corrosion up to an operating temperature of +350°C. Cryogenic down to -196°C.

**Base materials**

1.4306 X2CrNi19-11, 1.4301 X5CrNi18-10, 1.4311 X2CrNi18-10, 1.4312 GX10CrNi18-8, 1.4541 X6CrNiTi18-10, 1.4546 X5CrNiNb18-10, 1.4550 X6CrNiNb18-10 AISI 304, 304L, 304LN, 302, 321, 347, ASTM A157 Gr. C9, A320 Gr. B8C or D

**Typical composition of solid wire (Wt-%)**

C	Si	Mn	Cr	Ni
≤0.02	0,8	1,7	20,0	10,2

**Mechanical properties of all-weld metal**

Heat Treatment	Yield strength 0,2%	Tensile strength	Elongation ( $L_0=5d_0$ )	Impact values in J CVN
	MPa	MPa	%	+20°C:
untreated	390	540	38	110

**Operating data**

	Polarity = +	shielding gases: Argon + max. 2.5% CO <sub>2</sub>
---	--------------	---

**Dimensions (mm)**

0,8	1,0	1,2		
-----	-----	-----	--	--

**Approvals and certificates**

TÜV-D (03159.), DB (43.014.09), DNV (308L), GL (4550S), SEPROZ, CE

**Similar Allo Filler Metals**

SMAW electrode:	FOX EAS 2 FOX EAS 2-A	Flu cored wire:	EAS 2-FD EAS 2-MC EAS 2 PW-FD (LF)
SAW combination:	EAS 2-UP/BB 202		

**Thermanit JE-308L Si**

Solid Wire

<b>Classifications</b>	high-alloyed	
EN ISO 14343-A:	AWS A5.9:	
G 19 9 L Si	ER308LSi	

**Characteristics and field of use**

Stainless; resistant to intercrystalline corrosion and wet corrosion up to 350 °C (662 °F). Corrosion-resistant similar to matching low-carbon and stabilized austenitic 18/8 CrNi(N) steels/cast steel grades. Cold toughness at subzero temperatures as low as -196 °C (-321 °F). For joining and surfacing applications with matching and similar – stabilized and non-stabilized – austenitic CrNi(N) and CrNiMo(N) steels/cast steel grades. For joining and surfacing work on cryogenic matching/similar austenitic CrNi(N) steels/cast steel grades.

**Base materials**

TÜV-certified parent metal 1.4301 – X5CrNi18-10 1.4311 – X2CrNiN18-10; 1.4550 – X6CrNiNb18-10 AISI 304, 304L, 304LN, 302, 321, 347; ASTM A157 Gr. C9, A320 Gr. B8C or D.

**Typical composition of solid wire (Wt-%)**

C	Si	Mn	Cr	Ni
0,02	0,9	1,7	20,0	10,0

**Mechanical properties of all-weld metal**

Heat Treatment	Yield strength 0,2%	Tensile strength	Elongation ( $L_0=5d_0$ )	Impact values in J CVN	
	MPa	MPa	%	at RT	-196°C:
untreated	350	570	35	75	35

**Operating data**

	Polarity = +	Shielding gas (EN ISO 14175) M11, M12, M13
---	--------------	--

**Dimensions (mm)**

0,8	1,0	1,2	1,6
-----	-----	-----	-----

**Approvals and certificates**

TÜV (Certificate No. 0555) DB (Reg. form No. 43.132.08) CWB (ER 308L-Si) DNV

<b>Classifications</b>		high-alloyed	
EN ISO 14343-A:	AWS A5.9:		
G 23 12 L Si	ER309LSi		

**Characteristics and field of use**

Avesta 309L-Si is a high-alloy 23 Cr 13 Ni wire primarily intended for surfacing of lowalloy steels and dissimilar welds between mild steel and stainless steels, offering a ductile and crack resistant weldment. The chemical composition, when surfacing, is equivalent to that of 1.4301/ASTM 304 from the first run. One or two layers of 309L are usually combined with a final layer of 308L, 316L or 347.

**Corrosion resistance**

Superior to type 308L. When used for overlay welding on mild steel a corrosion resistance equivalent to that of 1.4301/ASTM 304 is obtained already in the first layer.

**Base materials**

For welding steels such as					
Outokumpu	EN	ASTM	BS	NF	SS
Avesta 309L-Si is primarily used when surfacing unalloyed or low-alloy steels and when joining non-molybdenum-alloyed stainless and carbon steels.					

8

**Typical composition of solid wire (Wt-%)**

C	Si	Mn	Cr	Ni
0,02	0,8	1,8	23,2	13,8

Ferrite 9 FN; WRC-92

**Mechanical properties of all-weld metal**

Heat Treatment	Yield strength 0,2%	Tensile strength	Elongation ( $L_0=5d_0$ )	Impact values in J CVN	
	MPa	MPa	%	+20°C:	-40°C:
untreated	400	600	32	110	100

**Operating data**

	Polarity = +	Shielding gas Ar + 2 % O <sub>2</sub> or 2-3 % CO <sub>2</sub> . Gas flow rate 12 – 16 l/min.
---	--------------	---

**Dimensions (mm)**

0,8	1,0	1,2	1,6
-----	-----	-----	-----

## Classifications

high-alloyed

EN ISO 14343-A:

AWS A5.9:

G 23 12 L

ER309L

## Characteristics and field of use

Solid wire electrode with increased ferrite content (FN ~16) in the weld metal. High crack resistance with hard-to-weld materials, austenite-ferrite joints and weld claddings. Dilution is to be kept as low as possible. Outstanding sliding and feeding characteristics. Very good welding and flow behaviour. Usable for operating temperatures between -80°C and +300°C.

## Base materials

Joints of and between high-strength, unalloyed and alloyed quenched and tempered steels, stainless, ferritic Cr and austenitic Cr-Ni steels, austenitic manganese steels and weld claddings: for the first layer of chemically resistant weld claddings on the ferritic-pearlitic steels used for boiler and pressure vessel construction up to fine-grained structural steel S500N, and for the creep resistant fine-grained structural steels 22NiMoCr4-7, 20MnMoNi5-5 and GS-18NiMoCr3 7.

## Typical composition of solid wire (Wt-%)

C	Si	Mn	Cr	Ni
≤0.02	0,5	1,7	23,5	13,2

## Mechanical properties of all-weld metal

Heat Treatment	Yield strength 0,2%	Tensile strength	Elongation ( $L_0=5d_0$ )	Impact values in J CVN	
				+20°C:	-80°C:
untreated	420	570	32	90	≥ 32

## Operating data

	Polarity = +	shielding gases: Argon + max. 2,5% CO <sub>2</sub> Argon + max. 1,0% O <sub>2</sub> Preheating and subsequent heat treatment depend on the base material being used.
---	--------------	---

## Dimensions (mm)

0,8	1,0	1,2		
-----	-----	-----	--	--

## Approvals and certificates

TÜV-D (4698.), DB (43.014.18), DNV (309L), GL (4332S), SEPROZ, CE

## Similar Allo Filler Metals

SMAW electrode:	FOX CN 23/12-A FOX CN 23/12 Mo-A	Flu cored wire:	CN 23/12-MC CN 23/12-FD CN 23/12 PW-FD CN 23/12 Mo-FD CN 23/12 Mo PW-FD
GTAW rod:	CN 23/12-UP/BB 202		
SAW combination:	CN 23/12-UP/BB 202		

# Thermanit 25/14 E-309L Si

Solid Wire

## Classifications

high-alloyed

EN ISO 14343-A:

AWS A5.9:

G 23 12 L Si

ER309LSi

## Characteristics and field of use

Stainless; (wet corrosion up to 350 °C (662 °F)). Well suited for depositing intermediate layers when welding clad materials. Favourably high Cr and Ni contents, low C content. For joining unalloyed/low-alloy steels/cast steel grades or stainless heat resistant Cr steels/cast steel grades to austenitic steels/cast steel grades. For depositing intermediate layers when welding the side of plates clad with low-carbon – non stabilized or stabilized – austenitic CrNiMo(N) austenitic metals.

## Base materials

Joints of and between high-tensile, unalloyed and alloyed quenched and tempered, stainless, ferritic Cr and austenitic CrNi steels, high manganese steels as well as weld claddings for the first layer of chemical resistant weld claddings on ferriticpearlitic steels up to fine grained structural steel S500N for steam boiler and pressure boiler constructions, as well as on creep resistant fine grained structural steels 22NiMoCr4-7 axx. to leaflet "SEW-Werkstoffblatt" No. 365, 366, 20MnMoNi5-5 and G18NiMoCr3-7.

## Typical composition of solid wire (Wt-%)

C	Si	Mn	Cr	Ni
0,03	0,9	2,0	24,0	13,0

## Mechanical properties of all-weld metal

Heat Treatment	Yield strength 0,2%	Tensile strength	Elongation ( $L_0=5d_0$ )	Impact values in J CVN	
	MPa	MPa	%	at RT	
untreated	400	550	30	55	

## Operating data

	Polarity = +	Shielding gas (EN ISO 14175) M12, M13
--	--------------	---------------------------------------

## Dimensions (mm)

0,8	1,0	1,2
-----	-----	-----

## Approvals and certificates

GL (4332 S) CBW (ER309LSi)

<b>Classifications</b>	high-alloyed	
EN ISO 14343-A:	AWS A5.9:	
G 22 12 H	ER309 (mod.)	

**Characteristics and field of use**

Solid wire electrode for same-type, heat resistant rolled, forged and cast steels, as well as for heat resistant ferritic Cr-Si-Al steels, such as in annealing shops, hardening shops, steam boiler construction, the petrochemical industry and the ceramic industry. Austenitic weld metal containing about 8% ferrite. Preferred for exposure to oxidising gases. Joints on Cr-Si-Al steels that are exposed to gases containing sulphur must be carried out using BÖHLER FOX FA or BÖHLER FA-IG as a final layer. Resistant to scaling up to +1000°C.

**Base materials**

austenitic 1.4828 X15CrNiSi20-12, 1.4826 GX40CrNiSi22-10, 1.4833 X12CrNi23-13 ferritic-pearlitic 1.4713 X10CrAlSi7, 1.4724 X10CrAlSi13, 1.4742 X10CrAlSi18, 1.4710 GX30CrSi7, 1.4740 GX40CrSi7 AISI 305, ASTM A297HF

**Typical composition of solid wire (Wt-%)**

C	Si	Mn	Cr	Ni
0.1	1,1	1,6	22,5	11,5

**Mechanical properties of all-weld metal**

Heat Treatment	Yield strength 0,2%	Tensile strength	Elongation ( $L_0=5d_0$ )	Impact values in J CVN	
				+20°C:	
untreated	480	620	34	110	

**Operating data**

	Polarity = +	shielding gas: Argon + max. 2,5% CO <sub>2</sub> Preheating and interpass temperature according to the base material and its thickness.
---	--------------	---

**Dimensions (mm)**

1,0	1,2			
-----	-----	--	--	--

**Approvals and certificates**

TÜV-A (26), SEPROZ

**Similar Allo Filler Metals**

SMAW electrode:	FOX FF FOX FF-A	GTAW rod:	FF-IG
-----------------	--------------------	-----------	-------

**Thermanit D**

Solid Wire

**Classifications**

high-alloyed

EN ISO 14343-A:

AWS A5.9:

G 22 12 H

ER309(mod.)

**Characteristics and field of use**

Resistant to scaling up to 950 °C (1742 °F). For joining and surfacing applications with matching/similar heat resistant steels/cast steel grades.

**Base materials**

1.4828 – X15CrNiSi20-12 AISI 305; ASTM A297HF

**Typical composition of solid wire (Wt-%)**

C	Si	Mn	Cr	Ni
0,11	1,2	1,2	22,0	11,0

**Mechanical properties of all-weld metal**

Heat Treatment	Yield strength 0,2%	Tensile strength	Elongation ( $L_0=5d_0$ )	Impact values in J CVN	
	MPa	MPa	%	at RT	
untreated	350	550	30	70	

**Operating data**

Polarity = +

Shielding gas (EN ISO 14175) M13

**Dimensions (mm)**

0,8	1,0	1,2	1,6
-----	-----	-----	-----

A	6L- KR-	Solid Wire
---	---------	------------

<b>Classifications</b>	high-alloyed	
EN ISO 14343-A:	AWS A5.9:	
G 19 12 3 L Si	ER316LSi	

#### Characteristics and field of use

Avesta 316L-Si/SKR-Si is designed for welding 1.4436/ASTM 316 type stainless steels. It is also suitable for welding steels that are stabilized with titanium or niobium, such as 1.4571/ASTM 316Ti, for service temperatures not exceeding 400°C. For higher temperatures, a niobium stabilised consumable such as Avesta 318-Si/SKNb-Si should be used.

#### Corrosion resistance

Excellent resistance to general, pitting and intergranular corrosion in chloride containing environments. Intended for severe service conditions, e.g. in dilute hot acids.

#### Base materials

For welding steels such as	EN	ASTM	BS	NF	SS
Outokumpu	EN	ASTM	BS	NF	SS
4436	1.4436	316	316S33	Z7 CND 18-12-03	2343
4432	1.4432	316L	316S13	Z3 CND 17-12-03	2353
4429	1.4429	S31653	316S63	Z3 CND 17-12 Az	2375
4571	1.4571	316Ti	320S31	Z6 CNDT 17-12	2350

#### Typical composition of solid wire (Wt-%)

C	Si	Mn	Cr	Ni	Mo
0,02	0,85	1,7	18,5	12,2	2,6

Ferrite 6 FN; WRC-92

#### Mechanical properties of all-weld metal

Heat Treatment	Yield strength	Tensile strength	Elongation	Impact values	
	0,2%		( $L_0=5d_0$ )	in J CVN	
	MPa	MPa	%	+20°C:	-196°C:
untreated	410	590	35	110	55

#### Operating data

	Polarity = +	Shielding gas Ar + 2 % O <sub>2</sub> or 2–3 % CO <sub>2</sub> . Gas flow rate 12–16 l/min.
---	--------------	---

#### Dimensions (mm)

0,8	1,0	1,2	1,6
-----	-----	-----	-----



**BÖHLER EAS 4 M-IG (Si)**

Solid Wire

**Classifications**

high-alloyed

EN ISO 14343-A:

AWS A5.9:

G 19 12 3 L Si

ER316LSi

**Characteristics and field of use**

Solid wire electrode for application in all branches of industry in which same-type steels and ferritic 13% chrome steels are welded, e.g. the construction of chemical apparatus and containers, the textile and cellulose industry, dye works, beverage production, synthetic resin plants and many more. Also suitable for media containing chlorides due to the inclusion of Mo. Outstanding sliding and feeding characteristics. Very good welding and flow behaviour. Resists intergranular corrosion up to an operating temperature of +400°C. Cryogenic down to -196°C.

**Base materials**

1.4401 X5CrNiMo17-12-2, 1.4404 X2CrNiMo17-12-2, 1.4435 X2CrNiMo18-14-3, 1.4436 X3CrNiMo17-13-3, 1.4571 X6CrNiMoTi17-12-2, 1.4580 X6CrNiMoNb17-12-2, 1.4583 X10CrNiMoNb18-12, 1.4409 GX2CrNiMo19-11-2 UNS S31603, S31653; AISI 316L, 316Ti, 316Cb

**Typical composition of solid wire (Wt-%)**

C	Si	Mn	Cr	Ni	Mo
≤0.02	0,8	1,7	18,4	12,4	2,8

**Mechanical properties of all-weld metal**

Heat Treatment	Yield strength 0,2%	Tensile strength	Elongation ( $L_0=5d_0$ )	Impact values in J CVN	
	MPa	MPa	%	+20°C:	
untreated	430	580	38	120	

**Operating data**

	Polarity = +	shielding gases: Argon + max. 2.5% CO <sub>2</sub>
---	--------------	---

**Dimensions (mm)**

0,8	1,0	1,2		
-----	-----	-----	--	--

**Approvals and certificates**

TÜV-D (03233), DB (43.014.11), DNV (316L), GL (4429S), Statoil, SEPROZ, CE

**Similar Allo Filler Metals**

SMAW electrode:	FOX EAS 4 M FOX EAS 4 M (LF) FOX EAS 4 M-A FOX EAS 4 M-VD	Flu cored wire:	EAS 4 M-MC EAS 4 M-FD EAS 4 PW-FD EAS 4 PW-FD (LF)
GTAW rod:	EAS 4 M-IG	SAW combination:	EAS 4 M-UP/BB 202

**Thermanit GE-316L Si**

Solid Wire

**Classifications**

high-alloyed

EN ISO 14343-A:

AWS A5.9:

G 19 12 3 L Si

ER316LSi

**Characteristics and field of use**

Stainless; resistant to intercrystalline corrosion and wet corrosion up to 400 °C (752 °F). Corrosion-resistance similar to matching low-carbon and stabilized austenitic 18/8 CrNiMo steels/cast steel grades. For joining and surfacing application with matching and similar – non-stabilized – austenitic CrNi(N) and CrNiMo(N) steels and cast steel grades.

**Base materials**

TÜV-certified parent metal 1.4583 – X10CrNiMoNb18-12; UNS S31653; AISI 316Cb, 316L, 316Ti

**Typical composition of solid wire (Wt-%)**

C	Si	Mn	Cr	Mo	Ni
0,02	0,8	1,7	18,8	2,8	12,5

**Mechanical properties of all-weld metal**

Heat Treatment	Yield strength 0,2%	Tensile strength	Elongation ( $L_0=5d_0$ )	Impact values in J CVN	
	MPa	MPa	%	at RT	
untreated	380	560	35	70	

**Operating data**

	Polarity = +	Shielding gas (EN ISO 14175) M12, M13
---	--------------	---------------------------------------

**Dimensions (mm)**

0,8	1,0	1,2	1,6
-----	-----	-----	-----

**Approvals and certificates**

TÜV (Certificate No. 0489) DB (Reg. form No. 43.132.10) LR (fV7R-12) CWB (ER 316L-Si) GL (4429S) DNV

A

- KN -

Solid Wire

**Classifications**

high-alloyed

EN ISO 14343-A:

G 19 12 3 Nb Si

**Characteristics and field of use**

Avesta 318-Si/SKNb-Si is designed for welding steels that are stabilised with titanium or niobium such as 1.4571/ASTM 316Ti and similar, providing improved high temperature properties, e.g. creep resistance, compared to low-carbon non-stabilised materials. 318-Si/SKNb-Si shows better properties than 316L-Si/SKR-Si at elevated temperatures and is therefore recommended for applications with service temperatures above 400 °C. A stabilised weldment has improved high temperature properties, e.g. creep resistance, compared to low-carbon non-stabilised grades.

**Corrosion resistance**

Corresponding to 1.4571/ASTM 316Ti, i.e. good resistance to general, pitting and intergranular corrosion.

**Base materials**

For welding steels such as					
Outokumpu	EN	ASTM	BS	NF	SS
4571	1.4571	316Ti	320S31	Z6 CNDT 17-12	2350

**Typical composition of solid wire (Wt-%)**

C	Si	Mn	Cr	Ni	Mo	Nb
0,04	0,85	1,3	19,0	12,0	2,6	12xC

Ferrite 10 FN; WRC-92 7 FN; WRC- 92

**Mechanical properties of all-weld metal**

Heat Treatment	Yield strength 0,2%	Tensile strength	Elongation ( $L_0=5d_0$ )	Impact values in J CVN	
				+20°C:	-40°C:
untreated	440	625	35	110	90

**Operating data**

	Polarity = +	Shielding gas Ar + 2 % O <sub>2</sub> or 2–3% CO <sub>2</sub> . Gas flow rate 12–16 l/min.
---	--------------	--

**Dimensions (mm)**

0,8	1,0	1,2	
-----	-----	-----	--

# BÖHLER ASN 5-IG (Si)

Solid Wire

<b>Classifications</b>	high-alloyed	
EN ISO 14343-A:	AWS A5.9:	
G Z18 16 5 N L	ER317L (mod.)	

## Characteristics and field of use

Solid wire electrode for corrosion-resistant, 3-4% Mo-alloyed CrNi steels. Suitable for strongly corrosive conditions, e.g. in the chemical industry, in flue gas desulphurisation plants, seawater desalination plant, and particularly in the paper, textile and cellulose industries. Also suitable for fan impellers, centrifuge drums etc. that are exposed to media containing chlorides.

The weld metal has distinct chemical resistance to stress corrosion cracking and to intergranular corrosion, and is highly resistant to pitting (PRE<sub>N</sub> 35). Resists intergranular corrosion up to an operating temperature of +400°C. Cryogenic down to -196°C. Good welding and flow behaviour.

## Base materials

1.4436 X3CrNiMo17-13-3, 1.4439 X2CrNiMoN17-13-5, 1.4429 X2CrNiMoN17-13-3, 1.4438 X2CrNiMo18-15-4, 1.4583 X10CrNiMoNb18-12  
AISI 316Cb, 316 LN, 317LN, 317L, UNS S31726

## Typical composition of solid wire (Wt-%)

C	Si	Mn	Cr	Ni	Mo	N	PRE <sub>N</sub>	FN
0,02	0,4	5,5	19,0	17,2	4,3	0,16	37,1	≤ 0,5

## Mechanical properties of all-weld metal

Heat Treatment	Yield strength 0,2%	Tensile strength	Elongation (L <sub>0</sub> =5d <sub>0</sub> )	Impact values in J CVN	
	MPa	MPa	%	+20°C:	-196°C:
untreated	430	650	35	110	≥ 32

## Operating data

	Polarity = +	shielding gases: Argon + 20-30% He + max. 2% CO <sub>2</sub> Argon + 20% He + 0.5% CO <sub>2</sub>
---	--------------	--

## Dimensions (mm)

1,0	1,2			
-----	-----	--	--	--

## Approvals and certificates

TÜV-D (04139.), DNV (X), GL (4439S), CE

## Similar Allo Filler Metals

SMAW electrode:	FOX ASN 5 FOX ASN 5-A	Flu cored wire:	E317L-FD* E317L PW-FD*
GTAW rod:	ASN 5-IG	SAW combination:	ASN 5-UP/BB 203

\* onl for similar-allo base materials, not full austenitic

# Thermanit A Si

Solid Wire

<b>Classifications</b>	high-alloyed	
EN ISO 14343-A:	AWS A5.9:	
G 19 12 3 Nb Si	ER318(mod.)	

## Characteristics and field of use

Stainless; resistant to intercrystalline corrosion and wet corrosion up to 400 °C (752 °F). Corrosion-resistant similar to matching stabilized CrNiMo steels. For joining and surfacing application on matching and similar – stabilized and non-stabilized – austenitic CrNi(N) and CrNiMo(N) steels and cast steel grades.

## Base materials

TÜV-certified parent metal 1.4583 – X10CrNiMoNb18-12; AISI 316L, 316Ti, 316Cb

## Typical composition of solid wire (Wt-%)

C	Si	Mn	Cr	Mo	Ni	Nb
0,05	0,8	1,5	19,0	2,8	12,0	≥12xC

## Mechanical properties of all-weld metal

Heat Treatment	Yield strength 0,2%	Tensile strength	Elongation ( $L_0=5d_0$ )	Impact values in J CVN	
	MPa	MPa	%	at RT	
untreated	390	600	30	70	

## Operating data

	Polarity = +	Shielding gas (EN ISO 14175) M12, M13
---	--------------	---------------------------------------

## Dimensions (mm)

0,8	1,0	1,2	1,6
-----	-----	-----	-----

## Approvals and certificates

TÜV (Certificate No. 0601) DB (Reg. form No. 43.132.02)

<b>Classifications</b>	high-alloyed	
EN ISO 14343-A:	AWS A5.9:	
G 19 9 Nb Si	ER347Si	

#### Characteristics and field of use

Solid wire electrode for application in all branches of industry in which same-type steels, including higher-carbon steels, and ferritic 13% chrome steels are welded, e.g. the construction of chemical apparatus and containers, the chemical, pharmaceutical and cellulose industries, and many more. Outstanding sliding and feeding characteristics. Very good welding and flow behaviour. Resists intergranular corrosion up to an operating temperature of +400°C. Cryogenic down to -196°C.

#### Base materials

1.4550 X6CrNiNb18-10, 1.4541 X6CrNiTi18-10, 1.4552 GX5CrNiNb19-11, 1.4301 X5CrNi18-10, 1.4312 GX10CrNi18-8, 1.4546 X5CrNiNb18-10, 1.4311 X2CrNi18-10, 1.4306 X2CrNi19-11  
AISI 347, 321, 302, 304, 304L, 304LN, ASTM A296 Gr. CF 8 C, A157 Gr. C9, A320 Gr. B8C or D

#### Typical composition of solid wire (Wt-%)

C	Si	Mn	Cr	Ni	Nb
≤0.035	0,8	1,3	19,4	9,7	+

#### Mechanical properties of all-weld metal

Heat Treatment	Yield strength 0,2%	Tensile strength	Elongation ( $L_0=5d_0$ )	Impact values in J CVN	
	MPa	MPa	%	+20°C:	
untreated	460	630	33	110	

#### Operating data

	Polarity = +	Shielding gases: Argon + max. 2.5% CO <sub>2</sub>
---	--------------	---

#### Dimensions (mm)

0,8	1,0	1,2		
-----	-----	-----	--	--

#### Approvals and certificates

TÜV-D (00025.), GL (4550S), LTSS, SEPROZ, NAKS, CE

#### Similar Allo Filler Metals

SMAW electrode:	FOX SAS 2 FOX SAS 2-A	Flu cored wire:	SAS 2-FD SAS 2 PW-FD
GTAW rod:	SAS 2-IG	SAW combination:	SAS 2-UP/BB 202

# Thermanit H Si

Solid Wire

<b>Classifications</b>	high-alloyed	
EN ISO 14343-A:	AWS A5.9:	
G 19 9 Nb Si	ER347Si	

## Characteristics and field of use

Stainless; resistant to intercrystalline corrosion and wet corrosion up to 400 °C (752 °F). Corrosion-resistant similar to matching stabilized austenitic CrNi steels/cast steel grades. For joining and surfacing application with matching and similar – stabilized and non-stabilized – austenitic CrNi(N) steels and cast steel grades.

## Base materials

TÜV-certified parent metal 1.4550 – X6CrNiNb18-10 and the parent metals also covered by VdTÜV-Merkblatt 1000; AISI 347, 321, 302, 304, 304L, 304LN; ASTM A296 Gr. CF 8C; A157 Gr. C9; A320 Gr. B8C or D

## Typical composition of solid wire (Wt-%)

C	Si	Mn	Cr	Ni	Nb
0,06	0,8	1,5	19,5	9,5	≥12xC

## Mechanical properties of all-weld metal

Heat Treatment	Yield strength 0,2%	Tensile strength	Elongation ( $L_0=5d_0$ )	Impact values in J CVN	
	MPa	MPa	%	at RT	
untreated	400	570	30	65	

## Operating data

	Polarity = +	Shielding gas (EN ISO 14175) M12, M13
---	--------------	---------------------------------------

## Dimensions (mm)

0,8	1,0	1,2		
-----	-----	-----	--	--

## Approvals and certificates

TÜV (Certificate No. 0604) DB (Reg. form No. 43.132.06)

**BÖHLER CN 13/4-IG**

Solid Wire

<b>Classifications</b>	high-alloyed	
EN ISO 14343-A:	AWS A5.9:	
G 13 4	ER410NiMo (mod.)	

**Characteristics and field of use**

Solid wire electrode for same-type corrosion-resistant, martensitic and martensitic-ferritic rolled, forged and cast steels. Used in the construction of water turbines and compressors, and in the construction of steam power stations. Resistant to water and steam. Very good welding and flow behaviour.

**Base materials**

1.4317 GX4CrNi13-4, 1.4313 X3CrNiMo13-4, 1.4407 GX5CrNiMo13-4, 1.4414 GX4CrNiMo13-4  
ACI Gr. CA6NM

**Typical composition of solid wire (Wt-%)**

C	Si	Mn	Cr	Ni	Mo
0.01	0,65	0,7	12,2	4,8	0,5

**Mechanical properties of all-weld metal**

Heat Treatment	Yield strength 0,2%	Tensile strength	Elongation ( $L_0=5d_0$ )	Impact values in J CVN	
				+20°C:	-20°C:
untreated	950	1210	12	36	
annealed*	760	890	17	80	≥ 47

\*annealed, 580°C/8h furnace down to 300°C/air - shielding gas Ar + 8-10% CO<sub>2</sub>

**Operating data**

	Polarity = +	shielding gases: Argon + 8-10% CO <sub>2</sub> Preheating and interpass temperature of thick-walled parts 100-160 C. Heat input max. 15 kJ/cm. Tempering at 580-620 C.
---	--------------	--

**Dimensions (mm)**

1,2				
-----	--	--	--	--

**Approvals and certificates**

TÜV-D (04110.), SEPROZ, CE

**Similar Allo Filler Metals**

SMAW electrode:	FOX CN 13/4 FOX CN 13/4 SUPRA	Flu cored wire:	CN 13/4-MC CN 13/4-MC (F)
GTAW solid wire:	CN 13/4-IG	SAW combination:	CN 13/4-UP/BB 203



<b>Classifications</b>	high-alloyed	
EN ISO 14343-A:	AWS A5.9:	
G 22 9 3 N L	ER2209	

#### Characteristics and field of use

Avesta 2205 is primarily designed for welding the duplex grade Outokumpu 2205 and similar but it can also be used for 2304 type of steels. Avesta 2205 provides a ferritic-austenitic weldment that combines many of the good properties of both ferritic and austenitic stainless steels. The welding can be performed using short, spray or pulsed arc. Welding using pulsed arc provides good results in both horizontal and vertical-up positions. The best flexibility is achieved by using pulsed arc and Ø 1.20 mm wire. The weldability of duplex steels is excellent, but the welding should be adapted to the base material, considering fluidity, joint design, heat input etc.

#### Corrosion resistance

Very good resistance to pitting and stress corrosion cracking in chloride containing environments. PREN 35. Meets the corrosion test requirements per ASTM G48 Methods A, B and E (22 C).

#### Base materials

For welding steels such as					
Outokumpu	EN	ASTM	BS	NF	SS
2205	1.4462	S32205	318S13	Z3 CND 22-05 Az	2377

#### Typical composition of solid wire (Wt-%)

C	Si	Mn	Cr	Ni	Mo	N
0,02	0,5	1,6	22,8	8,5	3,1	0,17

Ferrite 50 FN; WRC-92

#### Mechanical properties of all-weld metal

Heat Treatment	Yield strength 0,2%	Tensile strength	Elongation ( $L_0=5d_0$ )	Impact values in J CVN	
	MPa	MPa	%	+20°C:	-50°C:
untreated	560	780	30	150	100

#### Operating data

	Polarity = +	1. Ar + 30% He + 2.5% CO <sub>2</sub> 2. Ar + 2% O <sub>2</sub> or Ar + 2-3% CO <sub>2</sub> .
		Welding is best performed using argon with an addition of approx. 30% He and 2 – 3% CO <sub>2</sub> . The addition of helium (He), will increase the energy of the arc. Gas flow rate 12 – 16 l/min.

#### Dimensions (mm)

0,8	1,0	1,2	1,6
-----	-----	-----	-----

<b>Classifications</b>	high-alloyed	
EN ISO 14343-A:	AWS A5.9:	
G 22 9 3 N L	ER2209	

**Characteristics and field of use**

Solid wire electrode ideally suited to welding ferritic-austenitic duplex steels. As a result of the carefully adjusted alloy, the weld metal not only features high strength and toughness, but is also exceptionally resistant to stress corrosion cracking and to pitting (ASTM G48 / Method A). The welding consumable can be used in a temperature range from -60°C up to +250°C. To achieve the special properties of the weld metal, it is necessary to ensure controlled dilution and thorough back purging. Ferrite content 30-60 FN (WRC). The solid wire electrode has outstanding sliding and feeding characteristics, along with very good welding and flow behaviour.

**Base materials**

same-type duplex steels as well as similar-alloy, ferritic-austenitic materials of increased strength 1.4462 X2CrNiMoN22-5-3, 1.4362 X2CrNiN23-4, 1.4462 X2CrNiMoN22-5-3 with 1.4583 X10CrNi-MoNb18-12, 1.4462 X2CrNiMoN22-5-3 with P235GH/ P265GH, S255N, P295GH, S355N, 16Mo3 UNS S31803, S32205

**Typical composition of solid wire (Wt-%)**

C	Si	Mn	Cr	Ni	Mo	N	PRE <sub>N</sub>
≤0,015	0,4	1,7	22,5	8,8	3,2	0,15	≥35

**Mechanical properties of all-weld metal**

Heat Treatment	Yield strength	Tensile strength	Elongation	Impact values	
	0,2%		(L <sub>0</sub> =5d <sub>0</sub> )	in J CVN	
	MPa	MPa	%	+20°C:	-40°C:
untreated	660	830	28	85	≥ 32

**Operating data**

	Polarity = +	shielding gases: Argon + 20-30% He + max. 2% CO <sub>2</sub> Argon + 20-30% He + max. 1% O <sub>2</sub> Preheating and subsequent heat treatment are not necessary for the weld metal. The interpass temperature should not be allowed to exceed a maximum of +150 C.
--	--------------	--

**Dimensions (mm)**

1,0	1,2			
-----	-----	--	--	--

**Approvals and certificates**

TÜV-D (04483), DB (43.014.26), DNV (X), GL (4462S), Statoil, SEPROZ, CE

**Similar Allo Filler Metals**

SMAW electrode:	FOX CN 22/9 N-B FOX CN 22/9 N	Flu cored wire:	CN 22/9 N-FD CN 22/9 PW-FD
GTAW solid wire:	CN 22/9 N-IG	SAW combination:	CN 22/9 N-UP/BB 202

<b>Classifications</b>	high-alloyed	
EN ISO 14343-A:	AWS A5.9:	
G 22 9 3 N L	ER2209	

#### Characteristics and field of use

Stainless; resistant to intercrystalline corrosion (Application temp.: -40 °C (-40 °F) up to 250 °C (482 °F)). Good resistance to stress corrosion cracking in chlorine- and hydrogen sulphide-bearing environment. High Cr and Mo contents provide resistance to pitting corrosion. For joining and surfacing work on matching and similar austenitic steels/cast steel grades. Attention must be paid to embrittlement susceptibility of the parent metal.

#### Base materials

TÜV-certified duplex stainless steels 1.4462 – X2CrNiMoN22-5-3 and others, also combinations of aforementioned steels and ferritic steels up to S355J, 16Mo3 and 1.4583 – X10CrNiMoNb18-12 – UNS S31803, S32205

#### Typical composition of solid wire (Wt-%)

C	Si	Mn	Cr	Mo	Ni	N
0,025	0,5	1,6	23,0	3,0	9,0	0,14

#### Mechanical properties of all-weld metal

Heat Treatment	Yield strength 0,2%	Tensile strength	Elongation ( $L_0=5d_0$ )	Impact values in J CVN	
	MPa	MPa	%	at RT	
untreated	510	700	25	70	

#### Operating data

	Polarity = +	Shielding gas (EN ISO 14175) M12, M13
---	--------------	---------------------------------------

#### Dimensions (mm)

0,8	1,0	1,2	1,6
-----	-----	-----	-----

#### Approvals and certificates

TÜV (Certificate No. 3342) GL (4462S) DNV (W 11132)

# Avesta LDX 2101

Solid Wire

<b>Classifications</b>	high-alloyed	
EN ISO 14343-A:		
G 23 7 N L		

## Characteristics and field of use

Avesta LDX 2101 is designed for welding the duplex stainless steel Outokumpu LDX 2101, a "lean duplex" steel with excellent strength and medium corrosion resistance. The steel is mainly intended for applications such as civil engineering, storage tanks, containers etc. Avesta LDX 2101 is over alloyed with respect to nickel to ensure the right ferrite balance in the weld metal. Welding can be performed using short, spray or pulsed arc. Welding using pulsed arc provides good results in both horizontal and vertical-up positions. The best flexibility is achieved by using pulsed arc and Ø 1.20 mm wire. The weldability of duplex steels is excellent but the welding should be adapted to the base material, considering fluidity, joint design, heat input etc.

### Corrosion resistance

Good resistance to general corrosion. Better resistance to pitting, crevice corrosion and stress corrosion cracking than 1.4301/AISI 304

### Base materials

For welding steels such as					
Outokumpu	EN	ASTM	BS	NF	SS
LDX 2101	1.4162	S32101	-	-	-

### Typical composition of solid wire (Wt-%)

C	Si	Mn	Cr	Ni	Mo	N
0,02	0,5	0,8	23,2	7,3	0,5	0,14

Ferrite 45 FN; WRC-92

### Mechanical properties of all-weld metal

Heat Treatment	Yield strength 0,2%	Tensile strength	Elongation ( $L_0=5d_0$ )	Impact values in J CVN	
				+20°C:	-40°C:
untreated	520	710	32	150	110

### Operating data

	Polarity = +	Shielding gas
		1. Ar + 30% He + 2.5% CO <sub>2</sub> . 2. Ar + 2% O <sub>2</sub> or 2–3% CO <sub>2</sub> . Welding is best performed using argon with an addition of approx. 30% He and 2 – 3% CO <sub>2</sub> . The addition of helium (He), will increase the energy of the arc. Gas flow rate 12 – 16 l/min.

### Dimensions (mm)

0,8	1,0	1,2	1,6
-----	-----	-----	-----

## Classifications

high-alloyed

EN ISO 14343-A:

G 23 12 2 L

## Characteristics and field of use

Avesta P5 is a high-alloy low carbon wire of the 309LMO type, primarily designed for surfacing low-alloy steels and for welding dissimilar joints between stainless and mild or low-alloy steels. It is also suitable for welding steels like Armax®, Hardox®, durostat®, Weldox® and alform®. When used for surfacing, a composition equivalent to that of 1.4401/ASTM 316 is obtained already in the first layer.

**Corrosion resistance**

Superior to type 316L. When used for overlay welding on mild steel a corrosion resistance equivalent to that of 1.4401/ASTM 316 is obtained already in the first layer.

## Base materials

For welding steels such as					
Outokumpu	EN	ASTM	BS	NF	SS
Avesta P5 is primarily used when surfacing unalloyed or low-alloy steels and when joining molybdenum-alloyed stainless and carbon steels.					

## Typical composition of solid wire (Wt-%)

C	Si	Mn	Cr	Ni	Mo
0,015	0,35	1,4	21,5	15,0	2,6

Ferrite 8 FN; WRC-92

## Mechanical properties of all-weld metal

Heat Treatment	Yield strength 0,2%	Tensile strength	Elongation ( $L_0=5d_0$ )	Impact values in J CVN	
	MPa	MPa	%	+20°C:	-40°C:
untreated	390	610	31	75	60

## Operating data

	Polarity = +	Shielding gas Ar + 2 % O <sub>2</sub> or 2–3 % CO <sub>2</sub> . Gas flow rate 12–16 l/min.
---	--------------	---

## Dimensions (mm)

0,8	1,0	1,2	1,6
-----	-----	-----	-----

# Avesta 2507/P100

Solid Wire

## Classifications

high-alloyed

EN ISO 14343-A:

G 25 9 4 N L

## Characteristics and field of use

Avesta 2507/P100 is intended for welding super duplex alloys such as 2507, ASTM S32760, S32550 and S31260. Welding can be performed using short, spray or pulsed arc. Welding using pulsed arc provides good results in both horizontal and vertical- up positions. The best flexibility is achieved by using pulsed arc and Ø 1.20 mm wire. The weldability of duplex steels is excellent but the welding should be adapted to the base material, considering fluidity, joint design, heat input etc.

### Corrosion resistance

Very good resistance to pitting and stress corrosion cracking in chloride containing environments. PREN 41.5. Meets the corrosion test requirements per ASTM G48 Methods A, B and E (40 C).

## Base materials

For welding steels such as					
Outokumpu	EN	ASTM	BS	NF	SS
2507	1.4410	S32750	-	Z3 CND 25-06 Az	2328

## Typical composition of solid wire (Wt-%)

C	Si	Mn	Cr	Ni	Mo	N
0,015	0,35	0,5	25,0	9,5	3,9	0,25

Ferrite 50 FN; WRC-92

## Mechanical properties of all-weld metal

Heat Treatment	Yield strength 0,2%	Tensile strength	Elongation ( $L_0=5d_0$ )	Impact values in J CVN	
	MPa	MPa	%	+20°C:	-50°C:
untreated	600	830	27	140	100

## Operating data

	Polarity = +	Shielding gas 1. Ar 2. Ar + 30% He + 2.5% CO <sub>2</sub> 3. Ar + 2% O <sub>2</sub> or Ar + 2-3% CO <sub>2</sub> . Welding using pure argon will give a porosity free weld, but at the cost of arc stability. Mixtures with 2%CO <sub>2</sub> or 2% O <sub>2</sub> can also be used but may result in some porosity. Gas flow rate 12 – 16 l/min.
---	--------------	--

## Dimensions (mm)

0,8	1,0	1,2	1,6
-----	-----	-----	-----

**Thermanit 25/09 CuT**

GMAW Wire

**Classifications**

high-alloyed

EN ISO 14343-A:

AWS A5.9:

G 25 9 4 N L

ER2594

**Characteristics and field of use**

Stainless; resistant to intercrystalline corrosion (Application temp.: -50 °C (-58°F) up to +220 °C (48 F). Very good resistance to pitting corrosion and stress corrosion cracking due to the high CrMo(N) content (pitting index  $\geq 40$ ). Well suited for conditions in the offshore field.

**Base materials**

1.4501 – X2CrNiMoCuN25-7-4 - UNS S32760

1.4515 – GX3CrNiMoCuN26-6-3

1.4517 - GX3CrNiMoCuN25-6-3-3

25 % Cr-superduplex steels

**Typical composition of solid wire (Wt-%)**

C	Si	Mn	Cr	Mo	Ni	N	Cu	W
0,02	0,3	1,5	25,5	3,7	9,5	0,22	0,8	0,6

**Mechanical properties of all-weld metal**

Heat Treatment	Yield strength 0,2%	Tensile strength	Elongation ( $L_0=5d_0$ )	Impact values in J CVN	
	MPa	MPa	%	at RT	-46°C:
untreated	650	750	25	80	50

**Operating data**

	Polarity = +	Shielding gas (EN ISO 14175) M12, M13
---	--------------	---------------------------------------

**Dimensions (mm)**

1,0	1,2		
-----	-----	--	--

<b>Classifications</b>	high-alloyed	
EN ISO 14343-A:		
G 25 4		

**Characteristics and field of use**

Solid wire electrode for gas shielded arc welding of heat resistant same type or similar type steels. Ferritic-austenitic weld metal. Due to the low Ni content it is particularly recommended when there will be exposure to oxidising or reducing combustion gases containing sulphur. Resistant to scaling up to +1100 C.

**Base materials**

ferritic-austenitic  
 1.4821 X15CrNiSi25-4, 1.4823 GX40CrNiSi27-4  
 ferritic-pearlitic  
 1.4713 X10CrAlSi7, 1.4724 X10CrAlSi13, 1.4742 X10CrAlSi18, 1.4762 X10CrAlSi25,  
 1.4710 GX30CrSi7, 1.4740 GX40CrSi17  
 AISI 327, ASTM A297HC

**Typical composition of solid wire (Wt-%)**

C	Si	Mn	Cr	Ni		
0,07	0,8	1,2	25,7	4,5		

**Mechanical properties of all-weld metal**

Heat Treatment	Yield strength 0,2%	Tensile strength	Elongation ( $L_0=5d_0$ )	Impact values in J CVN
	MPa	MPa	%	+20°C:
untreated	520	690	20	50

**Operating data**

	Polarity = +	Shielding gas Argon + max. 2.5% CO2
---	--------------	--

**Dimensions (mm)**

1,0	1,2		
-----	-----	--	--

**Similar alloy filler metals**

SMAW electrode:	FOX FA	GTAW rod:	FA-IG
-----------------	--------	-----------	-------



# Thermanit L

Solid Wire

## Classifications

high-alloyed

EN ISO 14343-A:

G 25 4

## Characteristics and field of use

Stainless; corrosion-resistant similar to matching or similar Mo-free 25 % Cr(Ni) steels/cast steel grades. Should parent metal be susceptible to embrittlement interpass temperature must not be allowed to rise above 300 °C (572 °F). Resistant to scaling in air and oxidizing combustion gases up to 1150 °C (2102 °F). Good resistance in sulphureous combustion gases at elevated temperatures. For matching and similar heat resistant steels/cast steel grades.

## Base materials

1.4340 – GX40CrNi27-4 1.4347 – GX8CrNi26-7  
1.4821 – X20CrNiSi25-4 AISI 327; ASTM A297HC

## Typical composition of solid wire (Wt-%)

C	Si	Mn	Cr	Ni		
0,06	0,8	0,8	26,0	5,0		

## Mechanical properties of all-weld metal

Heat Treatment	Yield strength 0,2%	Tensile strength	Elongation ( $L_0=5d_0$ )	Hardness HB30
	MPa	MPa	%	
untreated	500	650	20	180

## Operating data



Polarity = +

Shielding gas (EN ISO 14175) M12, M13

## Dimensions (mm)

1,2

1,6

<b>Classifications</b>	high-alloyed	
EN ISO 14343-A:	AWS A5.9:	
G 25 20 Mn	ER310 (mod.)	

## Characteristics and field of use

Solid wire electrode for same-type, heat resistant rolled, forged and cast steels such as in annealing shops, hardening shops, steam boiler construction, the petrochemical industry and the ceramic industry. Fully austenitic weld metal. Preferred for exposure to gases that are oxidising, contain nitrogen or are low in oxygen. Joint welding on heat resistant Cr-Si-Al steels that are exposed to gases containing sulphur must be carried out using BÖHLER FOX FA or BÖHLER FA-IG as a final layer. Resistant to scaling up to +1200°C. Cryogenic down to -196°C. Due to the risk of embrittlement, the temperature range between +650-900°C should be avoided.

## Base materials

## austenitic

1.4841 X15CrNiSi25-21, 1.4845 X8CrNi25-21, 1.4828 X15CrNiSi20-12,  
1.4840 GX15CrNi25-20, 1.4846 X40CrNi25-21, 1.4826 GX40CrNiSi22-10

## ferritic-pearlitic

1.4713 X10CrAlSi7, 1.4724 X10CrAlSi13, 1.4742 X10CrAlSi18, 1.4762 X10CrAlSi25,  
1.4710 GX30CrSi7, 1.4740 GX40CrSi7  
AISI 305, 310, 314, ASTM A297 HF, A297 HJ

## Typical composition of solid wire (Wt-%)

C	Si	Mn	Cr	Ni		
0,13	0,9	3,2	24,6	20,5		

## Mechanical properties of all-weld metal

Heat Treatment	Yield strength 0,2%	Tensile strength	Elongation ( $L_0=5d_0$ )	Impact values in J CVN	
	MPa	MPa	%	+20°C:	-196°C:
untreated	400	620	38	95	≥ 32

## Operating data

	Polarity = +	Shielding gas Argon + max. 2.5% CO <sub>2</sub>
---	--------------	--

## Dimensions (mm)

0,8	1,0	1,2	
-----	-----	-----	--

## Approvals

SEPRO

## Similar alloy filler metals

SMAW electrode:	FOX FFB FOX FFB-A	GTAW rod:	FFB-IG
-----------------	----------------------	-----------	--------

## Classifications

high-alloyed

EN ISO 14343-A:

G Z17 Mo

## Characteristics and field of use

Solid wire electrode for hard facings on stainless steels with 13-18% Cr, as well as on gas, water and steam fittings of unalloyed or low-alloy steels for operating temperatures up to +500°C. Outstanding sliding and feeding characteristics. Very good welding and flow behaviour. Resistant to sea water and to scaling up to +900 C. The weld metal is usually still machinable, and has the same colour as base materials of a similar alloy. For joint welding, we recommend BÖHLER A 7-IG for the filler passes to increase toughness, and BÖHLER SKWAM-IG as the cover pass.

## Base materials

Corrosion-resistant surfacings: all unalloyed and low-alloy base materials suitable for welding. Joints: corrosion-resistant, Cr steels, suitable for quenching and tempering, with C contents  $\leq 0.20\%$  (repair welding). Pay attention to dilution and heat control.

## Typical composition of solid wire (Wt-%)

C	Si	Mn	Cr	Mo	Ni
$\leq 0.02$	0,65	0,55	17,0	1,1	0,4

## Mechanical properties of all-weld metal

Heat Treatment	Yield strength 0,2%	Tensile strength	Elongation ( $L_0=5d_0$ )	Brinell-hardness HB:
	MPa	MPa	%	
untreated				350
annealed*	$\geq 500$	$\geq 700$	$\geq 15$	200

\*annealed, 720°C/2 h – shielding gas Ar + 8-10% CO<sub>2</sub>

## Operating data

	Polarity = +	Shielding gas Argon + 8-10% CO <sub>2</sub> Argon + 3% O <sub>2</sub> or max. 5% CO <sub>2</sub>
--	--------------	--

## Dimensions (mm)

1,2	1,6
-----	-----

## Approvals

KTA 1408.1 (08044.), DB (20.014.19), SEPRO , CE

## Similar alloy filler metals

SMAW electrode:	FOX SKWA FOX SKWAM	GTAW rod:	KWA-IG SKWA-IG
-----------------	-----------------------	-----------	-------------------

# Thermanit 17/15 TT

Solid Wire

## Classifications

high-alloyed

EN ISO 14343-A:

GZ 17 15 Mn W

## Characteristics and field of use

Permitting toughness at subzero temperatures as low as -196 °C (-321 °F). Suitable for joining applications with cryogenic austenitic CrNi(N) steels/cast steel grades and cryogenic Ni steels suitable for quenching and tempering.

## Base materials

TÜV-certified parent metal  
1.5662 – X8Ni9 1.4311 – X2CrNiN18-10

## Typical composition of solid wire (Wt-%)

C	Si	Mn	Cr	Ni	W
0,2	0,4	10,5	17,5	14,0	3,5

## Mechanical properties of all-weld metal

Heat Treatment	Yield strength 0,2%	Tensile strength	Elongation ( $L_0=5d_0$ )	Impact values in J CVN	
				at RT	-196°C:
untreated	430	600	30	80	50

## Operating data

	Polarity = +	Shielding gas (EN ISO 14175) M12, M13, M21
---	--------------	--

## Dimensions (mm)

1,2				
-----	--	--	--	--

## Approvals

TÜV (Certificate No. 2890) BV (SAW (-196)) GL (5680S) LR (R/V13R-12) DNV (NV 5; [M13])

<b>Classifications</b>		high-alloyed
EN ISO 14343-A:	AWS A5.9:	
G Z18 L Nb	ER430 (mod.)	

### Characteristics and field of use

Special wire electrode for catalytic converters and silencers, exhaust mufflers, pipe junctions and intake manifolds made of same-type or similar-type materials.  
Resistant to scaling up to +900°C. Outstanding sliding and feeding characteristics.  
Very good welding and flow behaviour.

### Base materials

1.4511 X3CrNb17, 1.4016 X6Cr17 AISI 430

### Typical composition of solid wire (Wt-%)

C	Si	Mn	Cr	Nb		
0,02	0,5	0,5	18,0	12xC		

### Mechanical properties of all-weld metal

#### Brinell-hardness HB:

untreated 150

annealed 130

untreated, as-welded – shielding gas Ar + 8-10% CO<sub>2</sub>

annealed, 760°C/2h – shielding gas Ar + 8-10% CO<sub>2</sub>

### Operating data



Polarity = +

Shielding gas  
Argon + 5-10% CO<sub>2</sub>  
Argon + 1-3% O<sub>2</sub>

### Dimensions (mm)

1,0

**BÖHLER CAT 430 L Cb Ti-IG**

Solid Wire

**Classifications**

high-alloyed

EN ISO 14343-A:

AWS A5.9:

G ZCr 18 NbTi L

ER430Nb (mod.)

**Characteristics and field of use**

Special wire electrode for joints and surfacings in exhaust systems with same-type or similartype materials. Double stabilised (Nb + Ti) with reduced tendency to the formation of coarse grains. Resistant to scaling up to +900 °C.  
Outstanding sliding and feeding characteristics. Very good welding and flow behaviour.

**Base materials**

1.4509 X2CrTiNb18, 1.4016 X6Cr17, 1.4511 X3CrNb17 AISI 430, AISI 441

**Typical composition of solid wire (Wt-%)**

C	Si	Mn	Cr	Nb	Ti	
0,02	0,5	0,5	18,0	12xC	0,4	

**Mechanical properties of all-weld metal****Brinell-hardness HB:**

untreated 150

annealed 130

untreated, as-welded – shielding gas Ar + 0.5-5% CO<sub>2</sub>annealed, 760°C/2h – shielding gas Ar + 0.5-5% CO<sub>2</sub>**Operating data**

Polarity = +

 Shielding gas  
 Argon + 0,5-5% CO<sub>2</sub>  
 Argon + 0,5-3% O<sub>2</sub>
**Dimensions (mm)**

1,0 1,2

# Thermanit 439 Ti

Solid Wire

<b>Classifications</b>		high-alloyed
EN ISO 14343-A:	AWS A5.9:	
GZ 18 Ti L	ER439(mod.)	

## Characteristics and field of use

Stainless. Scaling resistant up to 900 °C (1652 °F). For joining and surfacing of similar and matching steels. Exhaust systems.

## Base materials

1.4016 – X6Cr17 – AISI 430, 1.4502 – X8CrTi18, 1.4510 – X3CrTi17, AISI 439

## Typical composition of solid wire (Wt-%)

C	Si	Mn	Cr	Ti		
≤0.03	0,8	0,8	18,0	≥12xC		

## Mechanical properties of all-weld metal

Heat Treatment	Yield strength 0,2%	Tensile strength	Elongation (L <sub>0</sub> =5d <sub>0</sub> )	Brinell-hardness HB:	
	MPa	MPa	%	HB30	
AW				≈150	
800 C/1 h	280	430	20	≈130	

## Operating data

	Polarity = +	Shielding gas (EN ISO 14175) M12, M13
---	--------------	---------------------------------------

## Dimensions (mm)

1,0	1,2			
-----	-----	--	--	--

# UTP A 2133 Mn

Solid Wire

<b>Classifications</b>	high-alloyed	
EN ISO 14343-A:		
GZ 21 33 Mn Nb		

## Characteristics and field of use

UTP A 2133 Mn is suitable for joining and surfacing heat resistant base materials of identical and of similar nature, such as

1.4859	G X 10 NiCrNb 32 20	UNS N08800
1.4876	X 10 NiCrAlTi 32 21	UNS N08810
1.4958	X 5 NiCrAlTi 31 20	UNS N08811
1.4959	X 8 NiCrAlTi 31 21	

A typical application is the root welding of centrifugally cast pipes in the petrochemical industry for operation temperatures up to 1050 °C in dependence with the atmosphere.

### Welding characteristics and special properties of the weld metal

Scale resistant up to 1050 °C. Good resistance to carburising atmosphere.

### Welding instruction

Clean the weld area thoroughly. Low heat input. Max. interpass temperature 150 °C.

## Typical composition of solid wire (Wt-%)

C	Si	Mn	Cr	Ni	Nb	Fe
0,12	0,3	4,5	21,0	33,0	1,2	balance

## Mechanical properties of all-weld metal

Heat Treatment	Yield strength 0,2%	Tensile strength	Elongation ( $L_0=5d_0$ )	Impact values in J CVN
	MPa	MPa	%	at room temperature
untreated	400	600	20	70

## Operating data

	Polarity = +	Shielding gas I1
--	--------------	------------------

## Dimensions (mm)

0,8	1,0	1,2	
-----	-----	-----	--

## Approvals

T V (No. 10451)



## Classifications

high-alloyed

EN ISO 14343-A:

GZ 25 35 Zr

## Characteristics and field of use

UTP A 2535 Nb is suitable for joinings and building up on identical and similar high heat resistant CrNi cast steel (centrifugal- and mould cast parts), such as

1.4852	G-X 40 NiCrSiNb 35 25
1.4857	G-X 40 NiCrSi 35 25

## Welding characteristics and special properties of the weld metal

The weld deposit is applicable in a low sulphur, carbon enriching atmosphere up to 1150 °C, such as reformer ovens in petrochemical installations.

### Welding instruction

Clean welding area carefully. No pre heating or post weld heat treatment. Keep heat input as low as possible and interpass temperature at max. 150 °C.

## Typical composition of solid wire (Wt-%)

C	Si	Mn	Cr	Ni	Nb	Ti	Zr	Fe
0,4	1,0	1,7	25,5	35,5	1,2	+	+	balance

## Mechanical properties of all-weld metal

Heat Treatment	Yield strength 0,2%	Tensile strength	Elongation ( $L_0=5d_0$ )	Impact values in J CVN
	MPa	MPa	%	
untreated	480	680	8	

## Operating data



Polarity = +

Shielding gas I1

## Dimensions (mm)

1,0                      1,2

<b>Classifications</b>	high-alloyed		
EN ISO 14343-A:	AWS A5.14		
S NiCr22Mo9Nb	ERNiCrMo-3		

**Characteristics and field of use**

Avesta P12 is a nickel base alloy designed for welding 6Mo-steels such as Outokumpu 254 SMO. It is also suitable for welding nickel base alloys type 625 and 825 and for dissimilar welds between stainless or nickel base alloys and mild steel. To minimise the risk of hot cracking when welding fully austenitic steels and nickel base alloys, heat input and interpass temperature must be low and there must be as little dilution as possible from the parent metal.

**Typical composition of solid wire (Wt-%)**

C	Si	Mn	Cr	Ni	Mo	Nb	Fe
0,01	0,2	0,1	22,0	balance	9,0	3,5	1.0

**Mechanical properties of all-weld metal**

Heat Treatment	Yield strength 0,2%	Tensile strength	Elongation ( $L_0=5d_0$ )	Impact values in J CVN		
	MPa	MPa	%	+20°C	-40°C	-196°C
untreated	460	740	41	150	140	130

**Operating data**

	Polarity = +	Shielding gas: Welding is best performed using, pulsed arc with a shielding gas of pure argon or Ar + 30% He + 2,5% CO <sub>2</sub> . The addition of helium (He), will increase the energy of the arc. Gas flow rate 12 - 16l/min.
---	--------------	---

Dimensions (mm)	Amperage (A)
0,8	90 - 130
1,0	185 - 215
1,2	200 - 250

**BÖHLER NIBAS 625-IG/NiCr 625-IG A\***

Solid Wire

**Classifications**

high-alloyed

EN ISO 18274:

AWS A5.14:

S Ni 6625 (NiCr22Mo9Nb)

ERNiCrMo-3

**Characteristics and field of use**

Alloy 825 and also to CrNiMo steels with a high Mo content (e.g. „6 Mo“ steels). This type is also suitable for creep resistant and highly creep resistant steels, heat resistant and cryogenic materials, dissimilar joints and low-alloy, hard-to-weld steels. Suitable for pressure vessel construction for -196°C to +550°C, otherwise with scaling resistance up to +1200°C (sulphur-free atmosphere). Because of the embrittlement of the base material between 600 and 850°C, use in this temperature range should be avoided. High resistance to hot cracking, in addition to which the C-diffusion at high temperatures or during heat treatment of dissimilar joints is largely inhibited. Extremely high resistance to stress corrosion cracking and pitting (PREN 52). Resistant to thermal shock, stainless, fully austenitic. Low expansion coefficient between C-steel and austenitic CrNi(Mo) steel. The wire and the weld metal meet the highest quality requirements.

**Base materials**

2.4856 NiCr22Mo9Nb, 2.4858 NiCr21Mo, 2.4816 NiCr15Fe, 1.4583 X10CrNiMoNb18-12, 1.4876 X10NiCrAlTi32-21, 1.4529 X1NiCrMoCuN25-20-7, X2CrNiMoCuN20-18-6, 2.4641 NiCr2 Mo6Cu. Joints of the above-mentioned materials with unalloyed and low-alloy steels such as P265GH, P285NH, P295GH, S355N, 16Mo3, X8Ni9, ASTM A 553 Gr.1, N 08926, Alloy 600, Alloy 625, Alloy 800 (H), 9% Ni steels

**Typical composition of solid wire (Wt-%)**

C	Si	Mn	Cr	Ni	Mo	Nb	Fe	Ti
≤ 0.02	0,1	0,1	22,0	bal	9,0	3,6	≤ 0,5	+

**Mechanical properties of all-weld metal**

Heat Treatment	Yield strength 0,2%	Tensile strength	Elongation ( $L_0=5d_0$ )	Impact values in J CVN	
	MPa	MPa	%	+20°C	-196°C
untreated	510	780	40	130	80

**Operating data**

	Polarity = +	Shielding gases: 100% Argon M12 (Argon +30% He + 0,5% CO <sub>2</sub> ) Ar + 28% He + 2% H <sub>2</sub> + 0,05% CO <sub>2</sub> The pulsed arc technique with argon or argon-helium mixtures is recommended for welding.
---	--------------	--

**Dimensions (mm)**

1,6	2,0	2,4
-----	-----	-----

**Approvals**

T V-D (04323.), Statoil, SEPRO, CE (NiCr 625-IG A: T V-D (09404.), DB (43.014.25), CE

**Similar alloy filler metals**

SMAW electrode:	FOX NIBAS 625	GTAW rod:	NIBAS 625-IG NiCr 625-IG A*
Flu cored wire:	NIBAS 625 PW-FD	SAW combination:	NIBAS 625-UP/BB 444

\* Product name in German

# UTP A 6222 Mo

Solid Wire

<b>Classifications</b>	high-alloyed	
EN ISO 18274	AWS A5.14	
S Ni 6625 (NiCr22Mo9Nb)	ER NiCrMo-3	

## Characteristics and field of use

UTP A 6222 Mo has a high nickel content and is suitable for welding high-strength and high-corrosion resistant nickel-base alloys, e. g.

X1 NiCrMoCuN25206	1.4529	UNS N08926
X1 NiCrMoCuN25205	1.4539	UNS N08904
NiCr21Mo	2.4858	UNS N08825
NiCr22Mo9Nb	2.4856	UNS N06625

It can be used for joining ferritic steel to austenitic steel as well as for surfacing on steel. It is also possible to weld 9 % nickel steels using this wire due to its high yield strength. Its wide range of uses is of particular significance in aviation, in chemical industry and in applications involving seawater.

### Welding characteristics and special properties of the weld metal

The special features of the weld metal of UTP A 6222 Mo include a good creep rupture strength, corrosion resistance, resistance to stress and hot cracking. It is highly resistant and tough even at working temperatures up to 1100° C. It has an extremely good fatigue resistance due to the alloying elements Mo and Nb in the NiCr-matrix. The weld metal is highly resistant to oxidation and is almost immune to stress corrosion cracking. It resists intergranular penetration without having been heat-treated.

### Welding instructions

The welding area has to be free from impurities (oil, paint, markings). Minimize heat input. The interpass temperature should not exceed 150 °C. Linear energy input 12 kJ/cm

### Typical composition of solid wire (Wt-%)

C	Si	Cr	Mo	Ni	Nb	Fe
0,02	0,2	22,0	9,0	balance	3,5	1,0

### Mechanical properties of all-weld metal

Heat Treatment	Yield strength 0,2%	Tensile strength	Elongation ( $L_0=5d_0$ )	Impact values in J CVN	
	MPa	MPa	%	+20°C	-196°C
untreated	460	740	30	100	85

### Operating data

	Polarity = +	Shielding gas Z-ArHeHC-30/2/0,05
---	--------------	----------------------------------

### Dimensions (mm)

0,8	1,0	1,2	1,6
-----	-----	-----	-----

### Approvals

TÜV (No. 03460; 03461), GL, DNV, ABS, LR (1,2mm MIG)

**Classifications**

high-alloyed

EN ISO 18274:

AWS A5.14:

S Ni 6082 (NiCr20Mn3Nb)

ERNiCr-3

**Characteristics and field of use**

MIG wire electrode for high-quality welded joints to nickel-based alloys, creep resistant and highly creep resistant materials, heat resistant and cryogenic materials, and also for low-alloy, hard-to-weld steels and dissimilar joints. Also for ferrite-austenite joints at operating temperatures  $\geq 300^{\circ}\text{C}$  or heat treatments. Suitable for pressure vessel construction for  $-196^{\circ}\text{C}$  to  $+550^{\circ}\text{C}$ , otherwise with scaling resistance up to  $+1200^{\circ}\text{C}$  (sulphur-free atmosphere). Does not tend to embrittlement, high resistance to hot cracking, in addition to which the C-diffusion at high temperatures or during heat treatment of dissimilar joints is largely inhibited. Resistant to thermal shock, stainless, fully austenitic. Low expansion coefficient between C-steel and austenitic Cr-Ni-(Mo) steel. The wire and the weld metal meet the highest quality requirements.

**Base materials**

2.4816 NiCr15Fe, 2.4817 LC-NiCr15Fe, Alloy 600, Alloy 600 L Nickel and nickel alloys, low-temperature steels up to X8Ni9, high-alloy Cr and CrNiMo steels, particularly for dissimilar joints, and their joints to unalloyed, low-alloy, creep resistant and highly creep resistant steels. Also suitable for the Alloy 800 (H) material.

**Typical composition of solid wire (Wt-%)**

C	Si	Mn	Cr	Ni	Ti	Nb	Fe
0.02	0,1	3,1	20.5	bal	+	2,6	$\leq 1,0$

**Mechanical properties of all-weld metal**

Heat Treatment	Yield strength 0,2%	Tensile strength	Elongation ( $L_0=5d_0$ )	Impact values in J CVN	
	MPa	MPa	%	+20°C	-196°C
untreated	420	680	40	160	80

**Operating data**

	Polarity = -	Shielding gas
		100% Argon M12 (Argon + 30% He + 0,5% CO <sub>2</sub> ) Ar + 28% He + 2% H <sub>2</sub> + 0,05% CO <sub>2</sub> The pulsed arc technique with argon or argon-helium mixtures is recommended for welding.

**Dimensions (mm)**

0,8	1,0	1,2
-----	-----	-----

**Approvals**

T V-D (04327.), Statoil, NAKS, SEPRO , CE (NiCr 70 Nb-IG A: T V-D (09402.), CE)

**Similar alloy filler metals**

SMAW electrode:	FOX NIBAS 70/20	GMAW solid wire:	NIBAS 70/20-IG NiCr 70 Nb-IG A*
Flu cored wire:	NIBAS 70/20-FD NIBAS 70/20 Mn-FD	SAW combination:	NIBAS 70/20-UP/BB 444

\* Product Name German

# Thermanit Nicro 82

Solid Wire

<b>Classifications</b>	high-alloyed	
EN ISO 18274:	AWS A5.14:	
S Ni 6082 (NiCr20Mn3Nb)	ERNiCr-3	

## Characteristics and field of use

Nickel based alloy; heat resistant; high temperature resistant. Cold toughness at subzero temperatures as low as -269°C (-452°F). Good for welding austenitic-ferritic joints. No Cr carbide zone that become brittle in the ferrite weld deposit transition zone, even as a result of heat treatments above 300°C (572°F). Good for fabricating tough joints and surfacing with heat resistant Cr and CrNi steels/cast steel grades and Ni-base alloys. Temperature limits: 500 C (932 F) in sulphureous atmospheres, 800°C (1472°F) max. for fully stressed welds. Resistant to scaling up to 1000°C (1832 F).

## Base materials

1.4876 - Alloy 800 - UNS N08800 - X10NiCrAlTi32-20, 1.4877 - X5NiCrCeNb32-27, 1.4958 - Alloy 800 H - UNS N08810 - X5NiCrAlTi31-20, 2.4816 - Alloy 600 - UNS N06600 - NiCr15Fe, 2.4817 - Alloy 600 L - UNS N06600 - LC-NiCr15Fe, 2.4858 - Alloy 825 - UNS N08825 - NiCr21Mo, 2.4851 - Alloy 601 - UNS N06601 - NiCr23Fe; Combinations of 1.4539 - X1NiCrMoCu25-20-5 1.4583 - X10CrNiMoNb18-12 and ferritic boiler steels; 1.5662 - X8Ni9; 1.7380 - 10CrMo9-10

## Typical composition of solid wire (Wt-%)

C	Si	Mn	Cr	Ni	Nb	Fe		
0,02	0,2	2,8	19,5	67	2,5	2,0		

## Mechanical properties of all-weld metal

Heat Treatment	Yield strength	Tensile strength	Elongation	Impact values
	0,2%		( $L_0=5d_0$ )	in J CVN
	MPa	MPa	%	at RT
untreated	380	620	35	90

## Operating data

	Polarity = +	Shielding gas (EN ISO 14175) I1
---	--------------	---------------------------------

## Dimensions (mm)

0,8	1,0	1,2	1,6
-----	-----	-----	-----

## Approvals

TÜV (Certificate No. 3089), DNV (NV 5 Ni), GL (NiCr20Nb)

<b>Classifications</b>	high-alloyed	
EN ISO 18274	AWS A5.14	
S Ni 6082 (NiCr20Mn3Nb)	ER NiCr-3	

#### Characteristics and field of use

UTP A 068 HH is predominantly used for joining identical or similar high heat resistant Ni-base alloys, heat resistant austenites, and for joining heat resistant austenitic-ferritic materials such as

2.4816	NiCr15Fe	UNS N06600
2.4817	LC- NiCr15Fe	UNS N10665
1.4876	X10 NiCrAlTi 32 20	UNS N08800
1.6907	X3 CrNiN 18 10	

Also used for joinings of high C content 25/35 CrNi cast steel to 1.4859 or 1.4876 for petrochemical installations with working temperatures up to 900 °C.

#### Welding characteristics and special properties of the weld metal

The welding deposit is hot cracking resistant and does not tend to embrittlement.

#### Welding instructions

Clean weld area thoroughly. Keep heat input as low as possible and interpass temperature at approx. 150 °C.

#### Typical composition of solid wire (Wt-%)

C	Si	Mn	Cr	Ni	Nb	Fe
0,02	0,2	3,0	20,0	balance	2,7	0,8

#### Mechanical properties of all-weld metal

Heat Treatment	Yield strength 0,2%	Tensile strength	Elongation ( $L_0=5d_0$ )	Impact values in J CVN	
				+20°C	-196°C
untreated	MPa 420	MPa 680	% 40	160	80

#### Operating data

	Polarity = +	Z-ArHeHC-30/2/0,05
---	--------------	--------------------

#### Dimensions (mm)

0,8	1,0	1,2	1,6
-----	-----	-----	-----

#### Approvals

TÜV (No. 00882; 00883), KTA, ABS, GL, DNV

# Thermanit 617

Solid Wire

<b>Classifications</b>	high-alloyed	
EN ISO 18274:	AWS A5.14:	
S Ni 6617 (NiCr22Co12Mo9)	ERNiCrCoMo-1	

## Characteristics and field of use

Resistant to scaling up to 1100 C (2012 F), high temperature resistant up to 1000 C (1832 F). High resistance to hot gases in oxidizing resp. carburizing atmospheres. Suited for joining and surfacing applications with matching and similar heat resistant steels and alloys. For joining and surfacing work on cryogenic Ni steels suitable for quenching and tempering.

## Base materials

1.4876 - Alloy 800 - UNS N08800 - X10NiCrAlTi32-20, 1.4958 - Alloy 800 H - UNS N08810 - X5NiCrAlTi31-20, 1.4859 - UNS N08151 - GX10NiCrNb32-20, 2.4851 - Alloy 601 - UNS N06601 - NiCr23Fe, 2.4663 - Alloy 617 - UNS 06617 - NiCr23Co12Mo

## Typical composition of solid wire (Wt-%)

C	Si	Mn	Cr	Mo	Ni	Co	Al	Ti	Fe
0,05	0,1	0,1	21,5	9,0	Rest	11,0	1,3	0,5	1,0

## Mechanical properties of all-weld metal

Heat Treatment	Yield strength	Tensile strength	Elongation	Impact values	
	0,2%		( $L_0=5d_0$ )	in J CVN	
	MPa	MPa	%	at RT	
untreated	400	700	40	100	

## Operating data

	Polarity = +	Shielding gas (EN ISO 14175) I1, M12 Ar + 30% He + 0,5% CO <sub>2</sub>
---	--------------	--

## Dimensions (mm)

1,0	1,2		
-----	-----	--	--

## Approvals

-
---



Classifications		high-alloyed
EN ISO 18274	AWS A5.14	
S Ni 6617 (NiCr22Co12Mo9)	ER NiCrCoMo-1	

### Characteristics and field of use

UTP A 6170 Co is particularly used for joining heat resistant and creep resistant nickel base alloys of identical and similar nature, high temperature austenitic and cast alloys, such as

1.4958	X5NiCrAlTi 31 20	UNS N08810
1.4959	X8NiCrAlTi 32 21	UNS N08811
2.4663	NiCr23Co12Mo	UNS N06617

### Welding characteristics and special properties of the weld metal

The weld metal is resistant to hot-cracking. It is used for operating temperatures up to 1100° C. Scale-resistant at temperatures up to 1100 °C in oxidizing resp. carburizing atmospheres, e. g. gas turbines, ethylene production plants.

### Welding instructions

Clean welding area carefully. Keep heat input as low as possible and interpass temperature at max. 150 °C.

### Typical composition of solid wire (Wt-%)

C	Si	Cr	Mo	Ni	Co	Ti	Al	Fe
0,06	0,3	22,0	8,5	balance	11,5	0,4	1,0	1,0

### Mechanical properties of all-weld metal

Heat Treatment	Yield strength 0,2%	Tensile strength	Elongation (L <sub>0</sub> =5d <sub>0</sub> )	Impact values in J CVN
	MPa	MPa	%	at room temperature
untreated	450	750	30	120

### Operating data

	Polarity = +	I1, Z-ArHeHC-30/2/0,05
--	--------------	------------------------

### Dimensions (mm)

0,8	1,0	1,2	1,6
-----	-----	-----	-----

### Approvals

TÜV (No. 05450; 05451)

# UTP A 776

Solid Wire

<b>Classifications</b>	high-alloyed	
EN ISO 18274	AWS A5.14	
S Ni 6276 (NiCr15Mo16Fe6W4)	ER NiCrMo-4	

## Characteristics and field of use

UTP A 776 is suitable for joint welding of matching base materials, as

2.4819	NiMo16Cr15W	UNS N10276
--------	-------------	------------

and surface weldings on low-alloyed steels. UTP A 776 is employed primarily for welding components in plants for chemical processes with highly corrosive media, but also for surfacing press tools, punches, etc. which operate at high temperature.

### Welding characteristics and special properties of the weld metal

Excellent resistance against sulphuric acids at high chloride concentrations.

### Welding instructions

To avoid intermetallic precipitations, stick electrodes should be welded with lowest possible heat input and interpass temperature.

## Typical composition of solid wire (Wt-%)

C	Si	Cr	Mo	Ni	V	W	Fe
0,01	0,07	16,0	16,0	balance	0,2	3,5	6,0

## Mechanical properties of all-weld metal

Heat Treatment	Yield strength 0,2%	Tensile strength	Elongation ( $L_0=5d_0$ )	Impact values in J CVN
	MPa	MPa	%	at room temperature
untreated	450	750	30	90

## Operating data

	Polarity = +	R1 Z-ArHeHC-30/2/0,05
---	--------------	-----------------------

## Dimensions (mm)

0,8	1,0	1,2	
-----	-----	-----	--

## Approvals

TÜV (No. 05586; 05587)

# Thermanit Nimo C 24

Solid Wire

<b>Classifications</b>	high-alloyed	
EN ISO 18274:	AWS A5.14:	
S Ni 6059 (NiCr23Mo16)	ERNiCrMo-13	

## Characteristics and field of use

Nickel based alloy. High corrosion resistance in reducing and, above all, in oxidizing environments. For joining and surfacing with matching and similar alloys and cast alloys. For welding the clad side of plates of matching and similar alloys.

## Base materials

### TÜV-certified parent metals

1.4565 – Alloy 24 – UNS S34565 – X2CrNiMnMoNbN25-18-5-4  
2.4602 – Alloy C-22 – UNS N06022 – NiCr21Mo14W  
2.4605 – Alloy 59 – UNS N06059 – NiCr23Mo16Al  
2.4610 – Alloy C-4 – UNS N06455 – NiMo16Cr16Ti  
2.4819 – Alloy C-276 – UNS N10276 – NiMo16Cr15W

## Typical composition of solid wire (Wt-%)

C	Si	Mn	Cr	Mo	Ni	Fe
0,01	0,10	0,5	23,0	16,0	balance	1,5

## Mechanical properties of all-weld metal

Heat Treatment	Yield strength 0,2%	Tensile strength	Elongation ( $L_0=5d_0$ )	Impact values in J CVN
	MPa	MPa	%	at RT
untreated	420	700	40	60

## Operating data

	Polarity = +, pulsed arc	Shielding gas (DIN EN ISO 14175) I1; Z - ArHeHC - 30/2/ 0,1
---	--------------------------	--

## Dimensions (mm)

1,0	1,2	1,6		
-----	-----	-----	--	--

## Approvals

TÜV (Certificate No. 6461)

<b>Classifications</b>	high-alloyed	
EN ISO 18274	AWS A5.14	
S Ni 6059 (NiCr23Mo16)	ER NiCrMo-13	

#### Characteristics and field of use

UTP A 759 is suitable for welding components in plants for chemical processes with highly corrosive media. For joining materials of the same or similar natures, e. g.

2.4602	NiCr21Mo14W	UNS N06022
2.4605	NiCr23Mo16Al	UNS N06059
2.4610	NiMo16Cr16Ti	UNS N06455
2.4819	NiMo16Cr15W	UNS N10276

and these materials with low alloyed steels such as for surfacing on low alloyed steels.

#### Welding characteristics and special properties of the weld metal

Good corrosion resistance against acetic acid and acetic hydride, hot contaminated sulphuric and phosphoric acids and other contaminated oxidising mineral acids. Intermetallic precipitation will be largely avoided.

#### Welding instructions

The welding area has to be free from impurities (oil, paint, markings). Minimize heat input. The interpass temperature should not exceed 150 °C. Linear energy input 12 kJ/cm

#### Typical composition of solid wire (Wt-%)

C	Si	Cr	Mo	Ni	Fe
0,01	0,1	22,5	15,5	balance	1,0

#### Mechanical properties of all-weld metal

Heat Treatment	Yield strength 0,2%	Tensile strength	Elongation ( $L_0=5d_0$ )	Impact values in J CVN
	MPa	MPa	%	at room temperature
untreated	450	720	35	100

#### Operating data

	Polarity = +	Z-ArHeHC-30/2/0,05
---	--------------	--------------------

#### Dimensions (mm)

0,8	1,0	1,2	1,6
-----	-----	-----	-----

#### Approvals

TÜV (No. 06065; 06068), GL

<b>Classifications</b>	high-alloyed	
EN ISO 18274	AWS A5.14	
S Ni 4060 (NiCu30Mn3Ti)	ER NiCu-7	

#### Characteristics and field of use

Particularly suited for the following materials: 2.4360 NiCu30Fe, 2.4375 NiCu30Al.  
UTP A 80 M is also used for joining different materials, such as steel to copper and copper alloys, steel to nickel-copper alloys. These materials are employed in high-grade apparatus construction, primarily for the chemical and petrochemical industries. A special application field is the fabrication of seawater evaporation plants and marine equipment.

#### Welding characteristics and special properties of the weld metal

The weld metal has an excellent resistance to a large amount of corrosive media, from pure water to non-oxidising mineral acids, alkali and salt solutions.

#### Welding instructions

Clean the weld area thoroughly to avoid porosity. Opening groove angle about 70°. Weld stringer beads.

#### Typical composition of solid wire (Wt-%)

C	Si	Mn	Cu	Ni	Ti	Fe
0,02	0,3	3,2	29,0	balance	2,4	1,0

#### Mechanical properties of all-weld metal

Heat Treatment	Yield strength 0,2%	Tensile strength	Elongation ( $L_0=5d_0$ )	Impact values in J CVN
	MPa	MPa	%	at room temperature
untreated	300	450	30	80

#### Operating data

	Polarity = +	I1, Z-ArHeHC-30/2/0,05
---	--------------	------------------------

#### Dimensions (mm)

0,8	1,0	1,2	
-----	-----	-----	--

#### Approvals

TÜV (No. 00249; 00250), ABS, GL

# Thermanit 35/45 Nb

Solid Wire

## Classifications

high-alloyed

EN ISO 18274:

S Ni Z (NiCr36Fe15Nb0,8)

## Characteristics and field of use

Resistant to scaling up to 1180 °C (2156 °F). For joining and surfacing work on matching/similar heat resistant cast steel grades

## Base materials

GX45NiCrNbSiTi45-35

## Typical composition of solid wire (Wt-%)

C	Si	Mn	Cr	Ni	Nb	
0,42	1,5	1,0	35,0	45,5	0,8	

## Mechanical properties of all-weld metal

Heat Treatment	Yield strength 0,2%	Tensile strength	Elongation ( $L_0=5d_0$ )	Impact values in J CVN
	MPa	MPa	%	at RT
untreated	245	450	6	-

## Operating data



Polarity = +

Shielding gas (EN ISO 14175) M12, M13

## Dimensions (mm)

1,2				
-----	--	--	--	--

**UTP A 3545 Nb**

Solid Wire

**Classifications**

high-alloyed

EN ISO 14343-A

GZ 35 45 Nb

**Characteristics and field of use**

UTP A 3545 Nb is suitable for joining and surfacing on identical and similar high heat resistant cast alloys (centrifugal- and mould cast parts), such as G X-45NiCrNbSiTi 45 35. The main application field is for tubes and cast parts of reformer and pyrolysis ovens at temperatures up to 1175°C/air.

**Typical composition of solid wire (Wt-%)**

C	Si	Mn	Cr	Ni	Nb	Ti	Zr	Fe
0,45	1,5	0,8	35,0	45,0	1,0	0,1	0,05	balance

**Mechanical properties of all-weld metal**

Heat Treatment	Yield strength 0,2%	Tensile strength	Elongation ( $L_0=5d_0$ )	Impact values in J CVN
	MPa	MPa	%	at room temperature
untreated	450	650	8	-

**Operating data**

Polarity = +

Shielding gas (EN ISO 14175) I1

**Dimensions (mm)**

1,2

## Chapter 4.1 - SAW Wire (low-alloyed, unalloyed)

Product name	EN ISO	AWS	Page
BOHLER EMS 2 + BB 24	S 38 6 FB S2	F7A8-EM12K (F6P6-EM12K)	2
Union S 2	S2	EM12	3
Union S 2 Si	S2Si	EM12K	4
Union S 3	S3	EH10K	5
Union S 3 Si	S3Si	EH12K	6
BOHLER EMS 2 Mo + BB 24	S 46 4 FB S2Mo	F8A4-EA2-A2/F8P0-EA2-A2	7
Union S 2 Mo	S2Mo	EA2	8
Union S 3 Mo	S3Mo	EA4	9
Union S 2 NiMo 1	SZ2Ni1Mo	EN1	10
BOHLER 3 NiMo 1-UP + BB 24	S 55 4 FB S3Ni1Mo	F9A4-EF3-F3	11
Union S 3 NiMo 1	S3Ni1Mo	EF3	12
Union S 3 NiMo	S3Ni1,5Mo	EG EF1 (mod.)	13
Union S 3 NiMoCr	SZ3Ni2,5CrMo	EG EF6 (mod.)	14
BOHLER 3 NiCrMo 2,5-UP + BB 24	S 69 6 FB S3Ni2,5CrMo	F11A8-EM4 (mod.)-M4H4	15
BOHLER EMS 2 CrMo + BB 24	S S CrMo1 FB	F8P2-EB2-B2	16
Union S 2 CrMo	S CrMo1	EB2R	17
Union S 1 CrMo 2	S CrMo2	EB3R	18
BOHLER CM 2-UP + BB 418 TT	S S CrMo2 FB	F8P2-EB3-B3	19
BOHLER C 9 MV-UP + BB 910	S S CrMo91 FB	EB9	20
Thermanit MTS 3	S CrMo91	EB9	21
Union S P 24	S Z CrMo2VNb	EG	22
Union S 1 CrMo 2 V	S ZCrMoV2	EG	23
Thermanit MTS 616	S ZCrMoWVNb 9 0,5 1,5	EG EB9(mod.)	24
BOHLER Ni 2-UP + BB 24	S 46 6 FB S2Ni2	F8A8-ENi2-Ni2	25
Union S 2 Ni 2,5	S2Ni2	ENi2	26
Union S 2 Ni 3,5	S2Ni3	ENi3	27



## Classifications

unalloyed

EN ISO 14171-A:

AWS A5.17:

S 38 6 FB S2

F7A8-EM12K (F6P6-EM12K)

## Characteristics and field of use

The BÖHLER EMS 3 wire electrode is universally applicable in shipbuilding, steel construction and in the fabrication of boilers and containers. It is suitable for joint welding of general structural steels and fine-grained structural steels. BÖHLER BB 24 is a fluoride-basic flux, and features an almost neutral metallurgical behaviour. The weld metal demonstrates good toughness properties down to -40 °C. A good seam appearance and good wetting properties, together with good slag detachability and low hydrogen content in the weld metal ( $\leq 5$  ml/100 g) characterise this wire/flux combination. It is particularly suitable for multi-pass welding of thick plates. More detailed information about BÖHLER BB 24 can be found in the product datasheet for the welding flux.

## Base materials

Steels up to a yield strength of 420 MPa (60 ksi) S235JR-S355JR, S235JO-S355JO, S235J2-S355J2, S275N-S420N, S275M-S420M, P235GH-P355GH, P275NL1-P355NL1, P215NL, P265NL, P355N, P285NH-P420NH, P195TR1-P265TR1, P195TR2-P265TR2, P195GH-P265GH, L245NB-L415NB, L245MBL415MB, GE200-GE240 ASTM A 106 Gr. A, B, C; A 181 Gr. 60, 70; A 283 Gr. A, C; A 285 Gr. A, B, C; A 350 Gr. LF1; A 414 Gr. A, B, C, D, E, F, G; A 501 Gr. B; A 513 Gr. 1018; A 516 Gr. 55, 60, 65, 70; A 573 Gr. 58, 65, 70; A 588 Gr. A, B, C, K; A 633 Gr. C, D, E; A 662 Gr. B; A 711 Gr. 1013; A 841 Gr. A, B, C; API 5 L Gr. B, X42, X52, X56, X60

## Typical analysis of all-weld metal (Wt-%)

C	Si	Mn		
0,07	0,25	1,2		

## Mechanical properties of all-weld metal

Heat Treatment	Yield strength 0,2%	Tensile strength	Elongation ( $L_0=5d_0$ )	Impact values in J CVN		
	MPa	MPa	%	+20°C:	-20°C:	-60°C:
untreated	440	520	30	185	170	90

## Operating data



Polarity = ±

re-drying for flux:  $\varnothing$  mm  
300-350 °C, min. 2 h

## Dimensions (mm)

2,0	2,5	3,0	4,0
-----	-----	-----	-----

## Approvals and certificates

Wire/flux combination: TÜV-D (7808.) Wire: TÜV-D (02603.), KTA 1408.1 (8058.), DB (52.014.03), SEPPOZ, CE

## Union S 2

SAW Wire

### Classifications

unalloyed

EN ISO 14171

AWS A5.17

S2

EM12

### Characteristics and field of use

General structural steels up to S355JR, boiler plates up to P295GH, shipbuilding steels, pipe steels up to L360 and unalloyed boiler tubes, fine grained structural steels up to P355N, S355N.

### Base materials

ASTM A36 Gr. all; A106 Gr. A, B; A214; A242 Gr. 1-5; A266 Gr. 1, 2, 4; A283 Gr. A, B, C, D; A285 Gr. A, B, C; A299 Gr. A, B; A328; A366; A515 Gr. 60, 65, 70; A516 Gr. 55; A556 Gr. B2A; A570 Gr. 30, 33, 36, 40, 45; A572 Gr. 42, 50; A606 Gr. all; A607 Gr. 45; A656 Gr. 50, 60; A668 Gr. A, B; A907 Gr. 30, 33, 36, 40; A841; A851 Gr. 1, 2; A935 Gr. 45; A936 Gr. 50;

### Typical analysis of the wire (Wt-%)

C	Si	Mn		
0,1	0,1	1,0		

### Available flux

Flu : UV 420 TT, UV 421 TT, UV 418 TT, UV 306, UV 400.

### Operating data



Polarity =  $\pm$

### Dimensions (mm)

2,0	2,5	3,0	4,0
-----	-----	-----	-----

## Union S 2 Si

SAW Wire

### Classifications

unalloyed

EN ISO 14171

AWS A5.17

S2Si

EM12K

### Characteristics and field of use

General structural steels up to S355JR, boiler plates up to P295GH, especially for pipe steels up to L360 and unalloyed boiler tubes.

### Base materials

-

### Typical analysis of the wire (Wt-%)

C

Si

Mn

0,1

0,3

1,0

### Available flux

UV 306, UV 400, UV 421 TT, UV 418 TT

### Operating data

Polarity =  $\pm$ 

### Dimensions (mm)

2,5

3,0

4,0

## Union S 3

SAW Wire

Classifications	unalloyed	
EN ISO 14171	AWS A5.17	
S3	EH10K	

### Characteristics and field of use

General structural steels up to S355JR, boiler plates up to P355GH, ship building steels, fine grained structural steels up to P355N, S355N.

### Base materials

ASTM A36 Gr. all; A106 Gr. A, B; A214; A242 Gr. 1-5; A266 Gr. 1, 2, 4; A283 Gr. A, B, C, D; A285 Gr. A, B, C; A299 Gr. A, B; A328; A366; A515 Gr. 60, 65, 70; A516 Gr. 55; A556 Gr. B2A; A570 Gr. 30, 33, 36, 40, 45; A572 Gr. 42, 50; A606 Gr. all; A607 Gr. 45; A656 Gr. 50, 60; A668 Gr. A, B; A907 Gr. 30, 33, 36, 40; A841; A851 Gr. 1, 2; A935 Gr. 45; A936 Gr. 50

### Typical analysis of the wire (Wt-%)

C	Si	Mn		
0,12	0,10	1,50		

### Available flux

UV 420 TT, UV 421 TT, UV 418 TT, UV 306, UV 400

### Operating data



Polarity =  $\pm$

### Dimensions (mm)

3,0	4,0	5,0	
-----	-----	-----	--

## Union S 3 Si

SAW Wire

### Classifications

unalloyed

EN ISO 14171

AWS A5.17

S3Si

EH12K

### Characteristics and field of use

General structural steels and fine grained structural steels up to S460N, P460N. Especially for offshore steels with flux UV 418 TT (COD tested).

### Base materials

-

### Typical analysis of the wire (Wt-%)

C

Si

Mn

0,10

0,30

1,70

### Available flux

UV 421 TT, UV 418 TT

### Operating data



Polarity =  $\pm$

### Dimensions (mm)

2,5

3,0

4,0

# BÖHLER EMS 2 Mo / BÖHLER BB 24

SAW Wire

<b>Classifications</b>	low-alloyed	
EN ISO14171-A:	AWS A5.23:	
S 46 4 FB S2Mo	F8A4-EA2-A2/F8P0-EA2-A2	

## Characteristics and field of use

Wire/flux combination for joint welding of creep resistant steels in boiler, container and pipeline construction. High-quality, tough weld metal, cryogenic down to -40°C. Approved for long-term use at operating temperatures of up to +550°C. Bruscato ≤ 15 ppm. More detailed information about BÖHLER BB 24 can be found in the detailed product datasheet for this welding flux.

## Base materials

creep resistant steels and cast steels of the same type, steels that are resistant to ageing and to caustic cracking, creep resistant structural steels with yield strengths up to 460 MPa. 16Mo3, 20MnMoNi4-5, 15NiCuMoNb5, S235JR-S355JR, S235JO-S355JO, S450JO, S235J2-S355J2, S275N-S460N, S275M-S460M, P235GH-P355GH, P355N, P285NH-P460NH, P195TR1-P265TR1, P195TR2-P265TR2, P195GH-P265GH, L245NB-L415NB, L450QB, L245MB-L450MB, GE200-GE300 ASTM A 29 Gr. 1013, 1016; A 106 Gr. C; A, B; A 182 Gr. F1; A 234 Gr. WP1; A 283 Gr. B, C, D; A 335 Gr. P1; A 501 Gr. B; A 533 Gr. B, C; A 510 Gr. 1013; A 512 Gr. 1021, 1026; A 513 Gr. 1021, 1026; A 516 Gr. 70; A 633 Gr. C; A 678 Gr. B; A 709 Gr. 36, 50; A 711 Gr. 1013; API 5 L B, X42, X52, X60, X65

## Typical analysis of all-weld metal (Wt-%)

C	Si	Mn	Mo	
0,07	0,25	1,15	0,5	

## Mechanical properties of all-weld metal

Heat Treatment	Yield strength 0,2%	Tensile strength	Elongation ( $L_0=5d_0$ )	Impact values in J CVN		
				+20°C:	-20°C:	-40°C:
untreated	MPa 540	MPa 630	% 25	140	80	

## Operating data

	Polarity = ±	re-drying of sub-arc flux: 300-350 °C, min. 2h
--	--------------	---

## Dimensions (mm)

1,0	2,0	2,5	3,0	4,0
-----	-----	-----	-----	-----

## Approvals and certificates

Wire/flux combination: TÜV-D (7810.), NAKS Wire: TÜV-D (02603.), KTA 1408 1 (8058./8060.), DB (52.014.06), SEPROZ, CE

## Similar alloy filler metals

SMAW electrode:	FOX DMO Kb FOX DMO Ti	Flu cored wire:	DMO Ti-FD
GMAW solid wire: GTAW rod	DMO-IG	SAW combination:	EMS 2 Mo/BB 306 EMS 2 Mo/BB 400 EMS 2 Mo/BB 418 TT EMS 2 Mo/BB 421 TT

## Union S 2 Mo

SAW Wire

### Classifications

low-alloyed

EN ISO 14171

AWS A5.23

S2Mo

EA2

### Characteristics and field of use

Mo-alloyed steels and boiler plates of quality 16Mo3, fine grained structural steels up to S460N, P460N, and corresponding pipeline steels up to StE 480 TM.

### Base materials

ASTM A355 Gr. P1, A161-94 Gr. T1A, A182M Gr. F1, A204M Gr. A, B, C, A250M Gr. T1, A217 Gr. WC1;

### Typical analysis of the wire (Wt-%)

C	Si	Mn	Mo	
0,10	0,10	1,00	0,50	

### Available flux

UV 420 TT, UV 421 TT, UV 418 TT, UV 400, UV 306, UV 309 P, UV 310 P

### Operating data

Polarity =  $\pm$ 

### Dimensions (mm)

3,0

4,0

# Union S 3 Mo

SAW Wire

## Classifications

low-alloyed

EN ISO 14171

AWS A5.23

S3Mo

EA4

## Characteristics and field of use

Mo-alloyed steels and boiler plates of quality 16Mo3 and fine grained structural steels up to S460N, P460N.

## Base materials

-

## Typical analysis of the wire (Wt-%)

C	Si	Mn	Mo	
0,12	0,10	1,50	0,50	

## Available flux

UV 420 TT, UV 421 TT, UV 418 TT

## Operating data



Polarity = ±

## Dimensions (mm)

3,0	4,0	5,0	
-----	-----	-----	--



# Union S 2 NiMo 1

SAW Wire

## Classifications

low-alloyed

EN ISO 14171

AWS A5.23

SZ2Ni1Mo

ENi1

## Characteristics and field of use

Creep resistant and cryogenic fine grained structural steels up to S460NL, P460NL and corresponding offshore and pipe steels.

## Base materials

-

## Typical analysis of the wire (Wt-%)

C	Si	Mn	Mo	Ni
0,11	0,10	1,0	0,25	0,90

## Available flux

UV 421 TT, UV 418 TT

## Operating data



Polarity =  $\pm$

## Dimensions (mm)

4,0

**BÖHLER 3 NiMo 1-UP / BÖHLER BB 24**

SAW Wire

**Classifications**

low-alloyed

EN ISO 26304-A:

AWS A5.23:

S 55 4 FB S3Ni1Mo

F9A4-EF3-F3

**Characteristics and field of use**

Wire/flux combination for joint welding of high-strength, quenched and tempered structural steels. The flux features an almost neutral metallurgical behaviour. The weld metal demonstrates good toughness properties at low temperatures. A good seam appearance and good wetting properties, together with good slag detachability and low hydrogen content in the weld metal ( $HD \leq 5 \text{ ml/100 g}$ ) characterise this wire/flux combination. It is particularly suitable for multi-pass welding of thick plates. More detailed information about BÖHLER BB 24 can be found in the detailed product datasheet for this welding flux.

**Base materials**

fine-grained structural steels S460N, S460M, S460NL, S460ML, S460Q-S555Q, S460QL-S550QL, S460QL1-S550QL1, P460N, P460NH, P460NL1, P460NL2, 20MnMoNi4-5, 15NiCuMoNb5-6-4, L415NB, L415MBL555MB, L415QB-L555QB, alform 500 M, 550 M, aldur 500 Q, 500 QL, 500 QL1, aldur 550 Q, 550 QL, 550 QL1 ASTM A 572 Gr. 65; A 633 Gr. E; A 738 Gr. A; A 852; API 5 L X60, X65, X70, X80, X60Q, X65Q, X70Q, X80Q

**Typical analysis of all-weld metal (Wt-%)**

C	Si	Mn	Ni	Mo
0,09	0,25	1,65	0,90	0,55

**Mechanical properties of all-weld metal**

Heat Treatment	Yield strength 0,2%	Tensile strength	Elongation ( $L_0=5d_0$ )	Impact values in J CVN			
				+20°C:	±0°C:	-20°C:	-40°C:
untreated	600	690	22	180	160	100	60

**Operating data**

	Polarity = ±	re-drying of sub-arc flux: 300-350 °C, min. 2 h
--	--------------	--

**Dimensions (mm)**

2,5	3,0	4,0
-----	-----	-----

**Approvals and certificates**

Wire/flux combination: TÜV-D (07807.) Wire: TÜV-D (2603.), CE, NAKS

# Union S 3 NiMo 1

SAW Wire

## Classifications

low-alloyed

EN ISO 14171

AWS A5.23

S3Ni1Mo

EF3

## Characteristics and field of use

Reactor structural steels such as 22 NiMoCr 37, 20 MnMo 44, 20 MnMoNi55, WB 36, Welmonil 35, Welmonil 43, GS-18 NiMoCr 37; In Combination with UV 420 TTR tested according to KTA 1408.

## Base materials

ASTM A517 Gr. A, B, C, E, F, H, J, K, M, P; A255 Gr. C; A633 Gr. E; A572 Gr. 65;

## Typical analysis of the wire (Wt-%)

C	Si	Mn	Mo	Ni
0,12	0,10	1,60	0,60	0,95

## Available flux

UV 420 TT (R), UV 421 TT, UV 418 TT

## Operating data



Polarity = ±

## Dimensions (mm)

2,5

3,0

4,0

# Union S 3 NiMo

SAW Wire

## Classifications

low-alloyed

EN ISO 14171

AWS A5.23

S3Ni1,5Mo

EG EF1 (mod.)

## Characteristics and field of use

-

## Base materials

Creep resistant and cryogenic fine grained structural steels up to S550NL, P550ML and WB 35, WB 36, H 80.

## Typical analysis of the wire (Wt-%)

C	Si	Mn	Mo	Ni
0,08	0,10	1,50	0,45	1,50

## Available flux

UV 420 TTR, UV 421 TT, UV 418 TT

## Operating data



Polarity =  $\pm$

## Dimensions (mm)

3,0

4,0

# Union S 3 NiMoCr

SAW Wire

## Classifications

low-alloyed

EN ISO 26304-A

AWS A5.23

SZ3Ni2,5CrMo

EG EF6 (mod.)

## Characteristics and field of use

-

## Base materials

Fine grained structural steels water quenched and tempered up to P690Q such as N-A-XTRA 70, T 1 and H 100. USS-T 1 etc.;

## Typical analysis of the wire (Wt-%)

C	Si	Mn	Cr	Mo	Ni
0,14	0,10	1,70	0,35	0,60	2,10

## Available flux

UV 421 TT, UV 418 TT

## Operating data



Polarity = ±

## Dimensions (mm)

2,0

3,0

4,0

**BÖHLER 3 NiCrMo 2,5-UP / BÖHLER BB 24**

SAW Wire

<b>Classifications</b>	low-alloyed	
EN ISO 26304-A:	AWS A5.23:	
S 69 6 FB S3Ni2,5CrMo	F11A8-EM4 (mod.)-M4H4	

**Characteristics and field of use**

Wire/flux combination specially suited to high-strength fine-grained structural steels. The weld metal is suitable for subsequent quenching and tempering. The flux features an almost neutral metallurgical behaviour. The weld metal demonstrates good toughness properties at low temperatures down to -60 °C. A good seam appearance and good wetting properties, together with good slag detachability and low hydrogen content in the weld metal ( $\leq 5$  ml/100 g) characterise this wire/flux combination. It is particularly suitable for multi-pass welding of thick plates. More detailed information about BÖHLER BB 24 can be found in the detailed product datasheet for this welding flux.

**Base materials**

quenched and tempered fine-grained structural steels with high requirements for low-temperature toughness. S690Q, S690QL, S690QL1, alform plate 620 M, alform plate 700 M, aldur 620 Q, aldur 620 QL, aldur 620 QL1, aldur 700 Q, aldur 700 QL, aldur 700 QL1  
ASTM A 514 Gr. F, H, Q; A 709 Gr. 100 Type B, E, F, H, Q; A 709 Gr. HPS 100W

**Typical analysis of all-weld metal (Wt-%)**

C	Si	Mn	Cr	Ni	Mo
0,06	0,3	1,5	0,5	2,2	0,5

15

**Mechanical properties of all-weld metal**

Heat Treatment	Yield strength 0,2%	Tensile strength	Elongation ( $L_0=5d_0$ )	Impact values in J CVN			
				+20°C:	-20°C:	-40°C:	-60°C:
untreated	740	850	20	120	90	85	( $\geq 47$ )

**Operating data**

	Polarity = $\pm$	re-drying of sub-arc flux: 300-350 °C / min. 2 h
--	------------------	---

**Dimensions (mm)**

3,0	4,0		
-----	-----	--	--

**Similar alloy filler metals**

SMAW electrode:	FOX EV 85		
GMAW solid wire:	X 70-IG NiCrMo 2.5-IG		

**Classifications**

low-alloyed

EN ISO 24598-A:

AWS A5.23:

S S CrMo1 FB

F8P2-EB2-B2

**Characteristics and field of use**

Wire/flux combination for joint welding of creep resistant steels in boiler, container and pipeline construction. Approved for long-term use at operating temperatures of up to +570°C. Bruscato ≤15 ppm. A good seam appearance and good wetting properties, together with good slag detachability and low hydrogen content in the weld metal (≤ 5 ml/100 g) characterise this wire/flux combination. More detailed information about BÖHLER BB 24 can be found in the detailed product datasheet for this welding flux. For step cooling applications, the BÖHLER BB 24-SC welding flux, which is specially developed for this purpose, should be used.

**Base materials**

same alloy creep resistant steels and cast steel, case-hardening and nitriding steels with comparable composition, heat treatable steels with comparable composition, steels resistant to caustic cracking 1.7335 13CrMo4-5, 1.7262 15CrMo5, 1.7728 16CrMoV4, 1.7218 25CrMo4, 1.7225 42CrMo4, 1.7258 24CrMo5, 1.7354 G22CrMo5-4, 1.7357 G17CrMo5-5  
 ASTM A 182 Gr. F12; A 193 Gr. B7; A 213 Gr. T12; A 217 Gr. WC6; A 234 Gr. WP11; A335 Gr. P11, P12; A 336 Gr. F11, F12; A 426 Gr. CP12

**Typical analysis of all-weld metal (Wt-%)**

C	Si	Mn	Cr	Mo	P	As	Sb	Sn
0,08	0,25	0,90	1,10	0,45	≤0.012	≤0.010	≤0.005	≤0.005

**Mechanical properties of all-weld metal**

Heat Treatment	Yield strength 0,2%	Tensile strength	Elongation (L <sub>0</sub> =5d <sub>0</sub> )	Impact values in J CVN		
	MPa	MPa	%	+20°C:	-30°C:	
a	(≥ 470)	(550-700)	(≥ 20)	(≥ 47)	(≥ 27)	
n+a	≥ 330	≥ 480	30	120		

(\*) a annealed, 680°C/2 h/furnace down to 300°C/air; n + a normalized 920°C and annealed 680°C/2 h

**Operating data**

	Polarity = ±	re-drying of sub-arc flux: 300-350 C, min. 2 h
---	--------------	---

**Dimensions (mm)**

2,5	3,0	4,0
-----	-----	-----

**Approvals and certificates**

Wire/flux combination: TÜV-D (7809.), Wire: TÜV-D (02605.), SEPROZ, CE

**Similar alloy filler metals**

SMAW electrode:	FOX DCMS Kb FOX DCMS Ti	SAW combination:	EMS 2 CrMo/BB 24 SC EMS 2 CrMo/BB 418 TT
GTAW rod:	DCMS-IG	Flu cored wire:	DCMS Ti-FD
Gas welding rod:	DCMS	GMAW solid wire:	DCMS-IG

## Union S 2 CrMo

SAW Wire

### Classifications

low-alloyed

EN ISO 24598-A

AWS A5.23

S CrMo1

EB2R

### Characteristics and field of use

CrMo-alloyed boiler plates and boiler tubes of quality 13CrMo4-5 and similar steels.

### Base materials

ASTM A193 Gr. B7, A355 Gr. P11 u. P12, A217 Gr. WC6;

### Typical analysis of the wire (Wt-%)

C	Si	Mn	Cr	Mo
0,12	0,10	0,80	1,20	0,50

### Available flux

UV 420 TTR (UV 420 TTR-W), UV 420 TT

### Operating data



Polarity = ±

### Dimensions (mm)

2,0

2,5

3,0

4,0



## Union S 1 CrMo 2

SAW Wire

### Classifications

low-alloyed

EN ISO 24598-A

AWS A5.23

S CrMo2

EB3R

### Characteristics and field of use

Creep resistant boiler structural steels 10CrMo9-10 i.g. 12CrMo9-10.

### Base materials

ASTM A335 Gr. P22, A217 Gr. WC9; A387 Gr. 22;

### Typical analysis of the wire (Wt-%)

C	Si	Mn	Cr	Mo
0,10	0,10	0,50	2,40	1,00

### Available flux

UV 420 TTR, UV 420 TTR-W

### Operating data



Polarity = ±

### Dimensions (mm)

2,5

3,0

4,0

5,0

# BÖHLER CM 2-UP / BÖHLER BB 418

SAW Wire

<b>Classifications</b>	low-alloyed	
EN ISO 24598-A:	AWS A5.23:	
S S CrMo2 FB	F8P2-EB3-B3	

## Characteristics and field of use

This consumable material is suitable for same alloy and similar alloy steels in boiler, pressure vessel and pipeline construction, and particularly for cracking plants in the petrochemical industry. The wire/flux combination can be used for long-term operating temperatures of up to +600°C. The heat control during the welding and the heat treatment following welding must be carried out similarly to the specifications of the steel manufacturer. More detailed information about BÖHLER BB 418 TT can be found in the detailed product datasheet for this welding flux. For step cooling applications, the BB 24 SC welding flux, which is specially developed for this purpose, should be used.

## Base materials

same type as creep-resistant steels and cast steels, similar alloy quenched and tempered steels up to 980 MPa strength, similar alloy case-hardening and nitriding steels 1.7380 10CrMo9-10, 1.7276 10CrMo11, 1.7281 16CrMo9-3, 1.7383 11CrMo9-10, 1.7379 G17CrMo9-10, 1.7382 G19CrMo9-10 ASTM A 182 Gr. F22; A 213 Gr. T22; A 234 Gr. WP22; 335 Gr. P22; A 336 Gr. F22; A 426 Gr. CP22

## Typical analysis of all-weld metal (Wt-%)

C	Si	Mn	Cr	Mo	P	As	Sb	Sn
0,08	0,2	0,7	2,4	0,95	≤0.010	≤0.015	≤0.005	≤0.010

## Mechanical properties of all-weld metal

Heat Treatment	Yield strength	Tensile strength	Elongation	Impact values			
	0,2%		( $L_0=5d_0$ )	in J CVN			
	MPa	MPa	%	+20°C:	-30°C:		
a	(≥ 470)	(≥ 550-700)	(≥ 18)	(≥ 47)	(≥ 27)		

(\*) a annealed, 690-750°C/2 h/furnace down to 300°C/air

## Operating data

	Polarity = ±	re-drying of sub-arc flux: 300-350 C, min. 2h
---	--------------	--

## Dimensions (mm)

2,5	3,0	4,0	
-----	-----	-----	--

## Approvals and certificates

Wire/flux combination: – Wire: TÜV-D (02605.), KTA 1408.1 (8060.), SEPROZ, CE

## Similar alloy filler metals

SMAW electrode:	FOX CM 2 Kb FOX CM 2 Kb SC	SAW combination:	CM 2 SC-UP/BB 24 CM 2 SC-UP/BB 24 SC
GTAW rod:	CM 2-IG	Flu cored wire:	CM 2 Ti-FD
GMAW solid wire:	CM 2-IG		

**BÖHLER C 9 MV-UP / BÖHLER BB 910**

SAW Wire

**Classifications**

low-alloyed

EN ISO 24598-A:

AWS A5.23:

S S CrMo91 FB

EB9

**Characteristics and field of use**

Wire/flux combination for highly creep resistant, quenched and tempered 9-12% chrome steels, particularly for T91/P91 steels in turbine and boiler construction and in the chemical industry. Approved for long-term use at operating temperatures of up to +650 °C. More detailed information about BÖHLER BB 910 can be found in the detailed product datasheet for this welding flux.

**Base materials**

same type as highly creep resistant steels 1.4903 X10CrMoVNb9-1, GX12CrMoVNbN9-1 ASTM A 335 Gr. P91, A 336 Gr. F91, A 369 Gr. FP91, A 387 Gr. 91, A 213 Gr. T91

**Typical analysis of all-weld metal (Wt-%)**

C	Si	Mn	Cr	Ni	Mo	V	Nb	N
0,10	0,25	0,65	8,70	0,45	0,93	0,19	0,05	0,04

**Mechanical properties of all-weld metal**

Heat Treatment	Yield strength 0,2%	Tensile strength	Elongation ( $L_0=5d_0$ )	Impact values in J CVN		
	MPa	MPa	%	+20°C:		
annealed	(≥ 540)	(620-760)	(≥ 17)	(≥ 47)		

annealed: 760 °C/2h / furnace up to 300 °C / air

**Operating data**

	Polarity = ±	re-drying of sub-arc flux: 300-350 °C, min. 2 h
---	--------------	--

**Dimensions (mm)**

2,5	3,0		
-----	-----	--	--

**Approvals and certificates**

TÜV-D (09185.), SEPROZ, CE

**Similar alloy filler metals**

SMAW electrode:	FOX C 9 MV	Metal cored wire:	C 9 MV-MC
GTAW rod:	C 9 MV-IG	Flu cored wire:	C 9 MV Ti-FD
GMAW solid wire:	C 9 MV-IG		

# Thermanit MTS 3

SAW Wire

## Classifications

low-alloyed

EN ISO 24598-A

AWS A5.23

S CrMo91

EB9

## Characteristics and field of use

-

## Base materials

Creep resistant 9 % Cr-Stahl such as X 10 CrMoVNb 9 1, A 213-T 91, A 335-P 91. ASTM A199 Gr. T91, A335 Gr. P91 (T91), A213/213M Gr. T91;

## Typical analysis of the wire (Wt-%)

C	Si	Mn	Cr	Mo	Ni	Nb	others
0,12	0,25	0,80	9,0	0,95	0,45	0,06	0,22 V

## Available flux

Marathon 543

## Operating data



Polarity =  $\pm$

## Dimensions (mm)

2,0

2,5

3,2

# Union S P 24

SAW Wire

## Classifications

low-alloyed

EN ISO 24598-A

AWS A5.23

SZCrMo2VNB

EG

## Characteristics and field of use

## Base materials

7CrMoVTiB10-10; (1.7378); T/P 24

## Typical analysis of the wire (Wt-%)

C	Si	Mn	Cr	Mo	others
0,10	0,20	0,60	2,50	1,0	V= 0,24 Ti/Nb= 0,05

## Available flux

UV P24

## Operating data



Polarity = ±

## Dimensions (mm)

2,0

# Union S 1 CrMo 2V

SAW Wire

## Classifications

low-alloyed

EN ISO 24598-A

AWS A5.23

S ZCrMoV2

EG

## Characteristics and field of use

### Base materials

Creep resistant steel of type 2 1/4 % Cr, 1 % Mo, 0,25 % V.

### Typical analysis of the wire (Wt-%)

C	Si	Mn	Cr	Mo	Nb	others
0,12	0,10	0,60	2,50	1,00	0,02	0,30 V

### Available flux

### Operating data



Polarity = ±

### Dimensions (mm)

4,0

# Thermanit MTS 616

SAW Wire

## Classifications

low-alloyed

EN ISO 24598-A

AWS A5.23

S ZCrMoWVNb9 0,5 1,5

EG B9 (mod.)

## Characteristics and field of use

Creep resistant martensitic steel of type P 92 0.22 V acc. to ASTM A 335.

## Base materials

ASTM A355 Gr. P92 (T92), A213/213M Gr. T92;

## Typical analysis of the wire (Wt-%)

C	Si	Mn	Cr	Mo	Ni	Nb	others
0,11	0,25	0,80	8,8	0,45	0,45	0,06	1,65 W 0,22 V

## Available flux

Marathon 543

## Operating data



Polarity = ±

## Dimensions (mm)

2,5

3,0

**BÖHLER Ni 2-UP / BÖHLER BB 24**

SAW Wire

<b>Classifications</b>	low-alloyed	
EN ISO 14171-A:	AWS A5.23:	
S 46 6 FB S2Ni2	F8A8-ENi2-Ni2	

**Characteristics and field of use**

Wire/flux combination for joint welding of cryogenic structural and nickel steels. The weld metal (untreated and stress-relieved) is characterised by outstanding low-temperature toughness and ageing resistance. The flux features an almost neutral metallurgical behaviour. A good seam appearance and good wetting properties, together with good slag detachability and low hydrogen content in the weld metal ( $\leq 5$  ml/100 g) characterise this wire/flux combination. It is particularly suitable for multi-pass welding of thick plates. More detailed information about BÖHLER BB 24 can be found in the detailed product datasheet for this welding flux.

**Base materials**

cryogenic fine-grained structural and Ni-alloy steels 10Ni14, 12Ni14, 13MnNi6-3, 15NiMn6, S275N-S460N, S275NL-S460NL, S275M-S460M, S275ML-S460ML, P275NL1-P460NL1, P275NL2-P460NL2  
 ASTM A 203 Gr. D, E; A 333 Gr. 3; A334 Gr. 3; A 350 Gr. LF1, LF2, LF3; A 420 Gr. WPL3, WPL6; A 516 Gr. 60, 65; AA 529 Gr. 50; A 572 Gr. 42, 65; A 633 Gr. A, D, E; A 662 Gr. A, B, C; A 707 Gr. L1, L2, L3; A 738 Gr. A; A 841 A, B, C

**Typical analysis of all-weld metal (Wt-%)**

C	Si	Mn	Ni	
0,07	0,25	1,15	2,2	

**Mechanical properties of all-weld metal**

Heat Treatment	Yield strength 0,2%	Tensile strength	Elongation ( $L_0=5d_0$ )	Impact values in J CVN		
				+20°C:	-20°C:	-60°C:
untreated	( $\geq 460$ )	(550-740)	( $\geq 20$ )	160	100	( $\geq 47$ )

**Operating data**

	Polarity = $\pm$	re-drying of sub-arc flux: 300-350 °C, min. 2 h
--	------------------	--

**Dimensions (mm)**

2,5	3,0		
-----	-----	--	--

**Approvals and certificates**

Wire/flux combination: –  
 Wire: TÜV-D (2603.), KTA 1408.1 (8058.), DB (52.014.10), SEPROZ. CE

**Similar alloy filler metals**

SMAW electrode:	FOX 2.5 Ni	GTAW rod:	2.5 Ni-IG
GMAW solid wire:	2.5 Ni-IG		



## Union S 2 Ni 2,5

SAW Wire

### Classifications

low-alloyed

EN ISO 14171

AWS A5.23

S2Ni2

ENi2

### Characteristics and field of use

Cryogenic fine grained structural steels up to S460NL, P460NL and special structural steels such as 12 Ni 14 G 1.

### Base materials

ASTM A633 Gr. E, A572 Gr. 65, A203 Gr. D, A333 and 334 Gr. 3, A350 Gr. LF;

### Typical analysis of the wire (Wt-%)

C	Si	Mn	Ni	
0,10	0,10	1,00	2,50	

### Available flux

UV 421 TT, UV418 TT

### Operating data



Polarity = ±

### Dimensions (mm)

2,5

3,0

4,0

# Union S 2 Ni 3,5

SAW Wire

## Classifications

low-alloyed

EN ISO 14171

AWS A5.23

S2Ni3

ENi3

## Characteristics and field of use

### Base materials

For the welding of cryogenic steels: 10Ni14, SA350G.LF3, SA 203 Gr. D.

### Typical analysis of the wire (Wt-%)

C	Si	Mn	Ni	
0,09	0,15	0,90	3,30	

### Available flux

UV 421 TT, UV 418 TT

### Operating data



Polarity = ±

### Dimensions (mm)

3,0	4,0		
-----	-----	--	--



## Chapter 4.2 - SAW Wire (high-alloyed)

Product name	EN ISO	AWS	Page
BÖHLER A 7 CN-UP + BB 203	S 18 8 Mn	ER307 (mod.)	2
Thermanit X	S 18 8 Mn	ER307(mod.)	3
Avesta 308L/MVR	S 19 9 L	ER308L	4
Thermanit JE-308L	S 19 9 L	ER308L	5
Avesta 309L	S 23 12 L	ER309L	6
Thermanit 25/14 E-309L	S 23 12 L	ER309L	7
Avesta 316L/SKR	S 19 12 3 L	ER316L	8
BÖHLER EAS 4 M-UP + BB 202	S 19 12 3 L	ER316L	9
Thermanit GE-316L	S 19 12 3 L	ER316L	10
Thermanit A	S 19 12 3 Nb	ER318	11
Thermanit H-347	S 19 9 Nb	ER347	12
Avesta 2205	S 22 9 3 N L	ER2209	13
Thermanit 22/09	S 22 9 3 N L	ER2209	14
Avesta P5	S 23 12 2 L	ER309LMo(mod.)	15
Avesta LDX 2101	S 23 7 N L	-	16
Avesta 2507/P100	S 25 9 4 N L	ER2594	17
BÖHLER CN 13/4-UP	S 13 4	ER410NiMo (mod.)	18
Avesta P12	S Ni 6625 (NiCr22Mo9Nb)	ERNiCrMo-3	19
Thermanit 625	S Ni 6625 (NiCr22Mo9Nb)	ERNiCrMo-3	20
UTP UP 6222 Mo	S Ni 6625 (NiCr22Mo9Nb)	ERNiCrMo-3	21
Thermanit NicrO 82	S Ni 6082 (NiCr20Mn3Nb)	ERNiCr-3	22
Thermanit Nimo C 276	S Ni 6276 (NiCr15Mo16Fe6W4)	ERNiCrMo-4	23

<b>Classifications</b>		high-alloyed
EN ISO 14343-A:	AWS A5.9:	
S 18 8 Mn	ER307 (mod.)	

**Characteristics and field of use**

For joint welding between CrNi steels and unalloyed steels, and for build-up welding of the sealing surfaces of fittings and build-up welding on cogging, billet and profiled rolls. Properties of the weld metal: suitable for strain-hardening, very good cavitation resistance, crack resistant, resistant to thermal shock, resistant to scaling up to +850°C, no tendency to sigma-phase embrittlement above 500°C. Cryogenic down to -100°C. Heat treatment is possible. BÖHLER BB 203 is an agglomerated, fluoride-basic welding flux, and yields clean, finely rippled weld seams. Good slag detachability and low hydrogen content. More detailed information about BÖHLER BB 203 can be found in the detailed product datasheet for this welding flux.

**Base materials**

high-strength, unalloyed and alloyed structural, quenched and tempered and armour steels among themselves or among each other; unalloyed and alloyed boiler or structural steels with high-alloy Cr and Cr-Ni steels; heat-resistant steels up to +850°C; austenitic manganese steels together and with other steels; cryogenic plate and pipe steels together with cryogenic austenitic materials.

**Typical analysis of all-weld metal (Wt-%)**

C	Si	Mn	Cr	Ni
0,08	0,8	6,0	18,7	9,0

**Mechanical properties of all-weld metal**

Heat Treatment	Yield strength 0,2%	Tensile strength	Elongation (L <sub>0</sub> =5d <sub>0</sub> )	Impact values in J CVN		
	MPa	MPa	%	-100°C:		
untreated	(≥ 350)	(≥500)	(≥ 25)	(≥ 40)		

**Operating data**

	Polarity = ±	re-drying of sub-arc flux: 300-350°C, 2 h
--	--------------	---

**Dimensions (mm)**

2,4	3,0				
-----	-----	--	--	--	--

**Approvals and certificates**

Wire/flux combination: – Wire: TÜV-D (02604.), CE

**Similar alloy filler metals**

SMAW electrode:	FOXA 7 / FOXA 7 CN* FOXA 7-A	Flu cored wire:	A 7-MC, A 7-FD, A 7 PW-FD
GMAW solid wire:	A 7-IG / A 7 CN-IG*	GTAW rod:	A 7 CN-IG / A 7 CN-IG*

# Thermanit X

SAW Wire

<b>Classifications</b>	high-alloyed		
EN ISO 14343-A	AWS A5.9		
S 18 8 Mn	ER307(mod.)		

## Characteristics and field of use

Joints and surfacings on high tensile, unalloyed and alloyed structural, quenched and tempered, and armor steels, same parent metal or in combination; unalloyed and alloyed boiler or structural steels with highalloyed Cr and CrNi steels; heat resistant steels up to 850 °C (1562 °F); austenitic high manganese steel with matching and other steels. Cryogenic sheet metals and pipe steels in combination with austenitic parent metals.

## Base materials

## Typical analysis of all-weld metal (Wt-%)

C	Si	Mn	Cr	Ni
0,1	1,0	7,0	19,0	9,0

## Available flux

Marathon 104

## Mechanical properties of all-weld metal

Heat Treatment	Yield strength 0,2%	Tensile strength	Elongation ( $L_0=5d_0$ )	Impact values in J CVN
	MPa	MPa	%	at room temperature
untreated				

## Operating data

	Polarity = ±	
--	--------------	--

## Dimensions (mm)

2,0	2,4	3,0	4,0		
-----	-----	-----	-----	--	--

<b>Classifications</b>	high-alloyed	
EN ISO 14343	AWS A5.9	
S 19 9 L	ER308L	

## Characteristics and field of use

Avesta 308L/MVR is designed for welding 1.4301/ASTM 304 type stainless steels. It can also be used for welding steels that are stabilized with titanium or niobium, such as 1.4541/ASTM 321 and 1.4550/ASTM 347 in cases where the construction will be operating at temperatures below 400°C. For higher temperatures a niobium stabilised consumable such as Avesta 347/MVNb is required. Very good under fairly severe conditions, e.g. in oxidising acids and cold or dilute reducing acids.

## Base materials

For welding steels such as					
Outokumpu	EN	ASTM	BS	NF	SS
4301	1.4301	304	304S31	Z7 CN 18-09	2333
4307	1.4307	304L	304S11	Z3 CN 18-10	2352
4311	1.4311	304LN	304S61	Z3 CN 18-10 Az	2371
4541	1.4541	321	321S31	Z6 CNT 18-10	2337

## Typical analysis of all-weld metal (Wt-%)

C	Si	Mn	Cr	Ni
0,02	0,40	1,7	20,0	10,0

Ferrite 8 FN; WRC - 92

## Available flux

801, 805

## Mechanical properties of all-weld metal

Heat Treatment	Yield strength 0,2%	Tensile strength	Elongation ( $L_0=5d_0$ )	Impact values in J CVN		
				-20°C:	-40°C:	-196°C:
801	410	590	37	65	50	35
805	410	580	36	80	60	35

## Operating data

	Polarity = ±	
---	--------------	--

## Dimensions (mm)

1,6	2,4	3,2	4,0		
-----	-----	-----	-----	--	--

## Approvals and certificates

# Thermanit JE-308L

SAW Wire

<b>Classifications</b>	high-alloyed	
EN ISO 14343-A	AWS A5.9	
S 19 9 L	ER308L	

## Characteristics and field of use

Stainless; resistant to intercrystalline corrosion and wet corrosion up to 350 °C (662 °F). Corrosion-resistant similar to matching low-carbon and stabilized austenitic 18/8 CrNi(N) steels/cast steel grades. High toughness at subzero temperatures as low as -196 °C (-321 °F). For joining and surfacing applications with matching and similar – stabilized and non-stabilized – austenitic CrNi(N) and CrNiMo(N) steels/cast steel grades. For joining and surfacing work on cryogenic matching/similar austenitic CrNi(N) steels/cast steel grades.

## Base materials

1.4301; 1.4541; AISI 347, 321, 304, 304L, 304LN; ASTM A296 Gr. CF 8 C, A157 Gr. C9; A320 Gr. B8C oder D

## Typical analysis of the wire (Wt-%)

C	Si	Mn	Cr	Ni
0,025	0,6	1,8	20,0	9,8

## Available flux

Marathon 431

## Mechanical properties of all-weld metal

Heat Treatment	Yield strength	Tensile strength	Elongation	Impact values		
	0,2%		( $L_0=5d_0$ )	in J CVN		
	MPa	MPa	%	RT		
untreated	≥ 320	≥ 550	35	65		

## Operating data

	Polarity = ±	Shielding gas (EN ISO 14175) I1, I3
---	--------------	-------------------------------------

## Dimensions (mm)

2,4	3,0				
-----	-----	--	--	--	--

## Approvals and certificates

TÜV (Certificate No. 9451) DB (Reg. form No. 43.132.19) CWB (ER 308L) DNV



<b>Classifications</b>	high-alloyed	
EN ISO 14343	AWS A5.9	
S 23 12 L	ER309L	

#### Characteristics and field of use

Avesta 309L is a high-alloy 23 Cr 13 Ni wire primarily intended for surfacing low-alloy steels and for dissimilar welding between mild steels and stainless steels, offering a ductile and crack resistant weldment. The chemical composition, when surfacing, is equivalent to that of 1.4301/ASTM 304 from the first run. One or two layers of 309L are usually combined with a final layer of 308L, 316L or 347. Superior to type 308L. When used for overlay welding on mild steel a corrosion resistance equivalent to that of 1.4301/ASTM 304 is obtained already in the first layer.

#### Base materials

For welding steels such as

Outokumpu	EN	ASTM	BS	NF	SS
-----------	----	------	----	----	----

Avesta 309L is primarily used when joining non-molybdenum-alloyed stainless and carbon steels and for surfacing unalloyed or low-alloy steels.

#### Typical analysis of the wire (Wt-%)

C	Si	Mn	Cr	Ni
0,02	0,40	1,80	23,5	14,0

Ferrite 9 FN; WRC-92

#### Available flux

801, 805

#### Mechanical properties of all-weld metal

Heat Treatment	Yield strength 0,2%	Tensile strength	Elongation ( $L_0=5d_0$ )	Impact values in J CVN	
				+20°C:	-40°C:
801	430	590	32	60	50
805	440	580	32	70	60

#### Operating data



Polarity = ±

#### Dimensions (mm)

2,0	2,4	3,2		
-----	-----	-----	--	--

#### Approvals and certificates

**Thermanit 25/14 E-309L**

SAW Wire

**Classifications**

high-alloyed

EN ISO 14343

AWS A5.9

S 23 12 L

ER309L

**Characteristics and field of use**

Stainless; wet corrosion up to 350 °C (662 °F). Favourably high Cr- and Ni-contents, low C content. For joining unalloyed/low-alloy steels/cast steel grades or stainless heat resistant Cr-steels/cast steel grades to austenitic steels/cast steel grades.

**Base materials**

Joinings: of and between high-tensile, unalloyed and alloyed quenched and tempered steels, stainless, ferritic Cr and austenitic CrNi steels, high manganese steels. Weld claddings: for first layer of chemical resistant claddings on ferritic-pearlitic steels up to fine grained steel S500N used in steam boiler and pressure boiler construction, moreover for creep resistant fine grained structural steels 22NiMoCr4-7 acc. to leaflet "SEW-Werkstoffblatt" No. 365, 366, 20MnMoNi5-5 and G18NiMoCr3-7.

**Typical analysis of all-weld metal (Wt-%)**

C	Si	Mn	Cr	Ni
≤ 0,02	≤ 0,6	1,8	24,0	13,2

**Available flux**

Marathon 431

**Operating data**

Polarity = ±

**Dimensions (mm)**

2,4	3,2	4,0			
-----	-----	-----	--	--	--

# Avesta 316L/SKR

SAW Wire

<b>Classifications</b>	high-alloyed	
EN ISO 14343-A	AWS A5.9:	
S 19 12 3 L	ER316L	

## Characteristics and field of use

Avesta 316L/SKR is designed for welding 1.4436/ASTM 316 type stainless steels. It is also suitable for welding steels that are stabilised with titanium or niobium, such as 1.4571/ASTM 316Ti, for service temperatures not exceeding 400°C. For higher temperatures, a niobium stabilised consumable such as Avesta 318/SKNb should be used. Excellent resistance to general, pitting and intergranular corrosion in chloride containing environments. Intended for severe service conditions, e.g. in dilute hot acids.

## Base materials

For welding steels such as					
Outokumpu	EN	ASTM	BS	NF	SS
4436	1.4436	316	316S33	Z7 CND 18-12-03	2343
4432	1.4432	316L	316S13	Z3 CND 17-12-03	2353
4429	1.4429	S31653	316S63	Z3 CND 17-12-Az	2375
4571	1.4571	316Ti	320S31	Z6 CndT 17-12	2350

## Typical analysis of the wire (Wt-%)

C	Si	Mn	Cr	Ni	Mo
0,02	0,40	1,7	18,5	12,2	2,6

Ferrite 7 FN; WRC -92

## Available flux

801, 805

## Mechanical properties of all-weld metal

Heat Treatment	Yield strength 0,2%	Tensile strength	Elongation (L <sub>0</sub> =5d <sub>0</sub> )	Impact values in J CVN		
	MPa	MPa	%	+20°C:	-40°C:	-196°C:
801	410	570	35	70	60	30
805	415	560	36	80	70	35

## Operating data

	Polarity = ±
---	--------------

## Dimensions (mm)

1,6	2,0	2,4	3,2	4,0
-----	-----	-----	-----	-----

# BÖHLER EAS 4 M-UP / BÖHLER BB 202

SAW Wire

<b>Classifications</b>	high-alloyed	
EN ISO 14343-A:	AWS A5.9:	
S 19 12 3 L	ER316L	

## Characteristics and field of use

Wire/flux combination for single pass and multi-pass welding of austenitic CrNiMo steels. Smooth seam surface, easy slag removal without slag residues and good welding properties, including when used for fillet welds, characterise this combination. Applications in reactor construction, the construction of chemical apparatus and containers, in fitting manufacture in the textile, cellulose and dyeing industries etc. Usable for operating temperatures between -120°C and +400°C. BÖHLER BB 202 is an agglomerated, fluoride-basic welding flux characterised by low flux consumption and by good slag detachability. More detailed information about BÖHLER BB 202 can be found in the detailed product datasheet for this welding flux.

## Base materials

1.4401 X5CrNiMo17-12-2, 1.4404 X2CrNiMo17-12-2, 1.4435 X2CrNiMo18-14-3, 1.4436 X3CrNiMo17-13-3, 1.4571 X6CrNiMoTi17-12-2, 1.4580 X6CrNiMoNb17-12-2, 1.4583 X10CrNiMoNb18-12, 1.4409 GX2CrNiMo19-11-2 UNS S31603, S31653; AISI 316L, 316Ti, 316Cb

## Typical analysis of all-weld metal (Wt-%)

C	Si	Mn	Cr	Ni	Mo
0,02	0,60	1,2	18,0	12,2	2,8

## Mechanical properties of all-weld metal

Heat Treatment	Yield strength 0,2%	Tensile strength	Elongation ( $L_0=5d_0$ )	Impact values in J CVN			
				MPa	MPa	%	+20°C:
untreated	(≥ 320)	(≥ 510)	(≥ 25)	80	≥ 60	≥ 50	(≥ 32)

## Operating data

	Polarity = ±	re-drying of sub-arc flux: 300-350°C, min. 2 h
--	--------------	---

## Dimensions (mm)

2,0	2,4	3,2	4,0		
-----	-----	-----	-----	--	--

## Approvals and certificates

Wire/flux combination: TÜV-D (07508.), TÜV-D (09175 with BB 203)

Wire: TÜV-D (02604.), DB (52.014.13), SEPROZ, CE

## Similar alloy filler metals

SMAW electrode:	FOX EAS 4 M FOX EAS 4 M (LF) FOX EAS 4 M-A FOX EAS 4 M-VD	Flu cored wire:	EAS 4 M-MC EAS 4 M-FD EAS 4 PW-FD EAS 4 PW-FD (LF)
GTAW rod:	EAS 4 M-IG	GMAW solid wire:	EAS 4 M-IG (Si)

**Thermanit GE-316L**

SAW Wire

**Classifications**

high-alloyed

EN ISO 14343

AWS A5.9

S 19 12 3 L

ER316L

**Characteristics and field of use**

Stainless; resistant to intercrystalline corrosion and wet corrosion up to 400 °C (752 °F). Corrosion-resistance similar to matching low-carbon and stabilized austenitic 18/8 CrNiMo steels/cast steel grades. For joining and surfacing application with matching and similar – non-stabilized and stabilized – austenitic CrNi(N) and CrNiMo(N) steels and cast steel grades.

**Base materials**

Joints and surfacing with matching 431/213 CrNiMo steels such as 1.4404; 1.4541; 1.4435; UNS S31653; AISI 316, 316L, 316Ti, 316Cb

**Typical analysis of the wire (Wt-%)**

C	Si	Mn	Cr	Mo	Ni	others
≤ 0,02	≤ 0,6	1,7	18,5	2,8	12,2	N 0,04

**Available flux**

Marathon 431

**Operating data**

Polarity = ±

**Dimensions (mm)**

2,0	2,4	3,2	4,0		
-----	-----	-----	-----	--	--

# Thermanit A

SAW Wire

<b>Classifications</b>	high-alloyed	
EN ISO 14343	AWS A5.9	
S 19 12 3 Nb	ER318	

## Characteristics and field of use

Joints and surfacing with matching stabilized and non stabilized CrNiMo steels such as 1.4571; 1.4583;

## Base materials

AISI 316, 316L, 316Ti, 316 Cb

## Typical analysis of the wire (Wt-%)

C	Si	Mn	Cr	Mo	Ni	Nb
≤ 0,05	≤ 0,6	1,7	19,5	2,8	11,5	12xC

## Available flux

Marathon 431

## Operating data



Polarity = ±

## Dimensions (mm)

2,4	3,2	4,0			
-----	-----	-----	--	--	--

**Thermanit H-347**

SAW Wire

**Classifications**

high-alloyed

EN ISO 14343

AWS A5.9

S 19 9 Nb

ER347

**Characteristics and field of use**

Joints and surfacing with matching stabilized and non stabilized austenitic steels such as 1.4301; 1.4541;

**Base materials**

1.4301; 1.4541; AISI 347, 321, 304, 304L, 304LN; ASTM A296 Gr. CF 8 C, A157 Gr. C9; A320 Gr. B8C or D

**Typical analysis of the wire (Wt-%)**

C	Si	Mn	Cr	Ni	Nb
≤ 0,06	≤ 0,6	1,8	19,5	9,5	≥ 12xC

**Available flux**

Marathon 431

**Operating data**

Polarity = ±

**Dimensions (mm)**

2,4

3,0

4,0

ire

S

12

# Avesta 2205

SAW Wire

Classifications	high-alloyed	
EN ISO 14343	AWS A5.9	
S 22 9 3 N L	ER2209	

## Characteristics and field of use

Avesta 2205 is primarily designed for welding the duplex grade Outokumpu 2205 and similar steels. Avesta 2205 provides a ferritic-austenitic weldment that combines many of the good properties of both ferritic and austenitic stainless steels. Very good resistance to pitting and stress corrosion cracking in chloride containing environments.

## Base materials

For welding steels such as					
Outokumpu	EN	ASTM	BS	NF	SS
2205	1.4462	S32205	318S13	Z3 CDN 22-05 Az	2328

## Typical analysis of the wire (Wt-%)

C	Si	Mn	Cr	Ni	Mo	N
0,02	0,5	1,6	22,8	8,5	3,1	0,17

Ferrite 50 FN; WRC-92

## Available flux

805

## Mechanical properties of all-weld metal

Heat Treatment	Yield strength	Tensile strength	Elongation	Impact values	
	0,2%		( $L_0=5d_0$ )	in J CVN	
	MPa	MPa	%	+20°C:	-46°C:
805	600	800	27	100	70

## Operating data

	Polarity = ±	
--	--------------	--

## Dimensions (mm)

2,4	3,2	4,0			
-----	-----	-----	--	--	--



# Thermanit 22/09

SAW Wire

## Classifications

high-alloyed

EN ISO 14343

AWS A5.9

S 22 9 3 N L

ER2209

## Characteristics and field of use

Joints on matching Duplex steels such as 1.4462;

## Base materials

1.4462 UNS S31803, S32205

## Typical analysis of the wire (Wt-%)

C	Si	Mn	Cr	Mo	Ni	others
≤ 0,02	≤ 0,5	1,6	23,0	3,2	8,8	N 0,15

## Available flux

Marathon 431

## Operating data



Polarity = ±

## Dimensions (mm)

2,0

2,5

3,0

ire

S

14

# Avesta P5

SAW Wire

Classifications		high-alloyed
EN ISO 14343	AWS A5.9	
S 23 12 2 L	ER309LMo(mod.)	

## Characteristics and field of use

Avesta P5 is a high-alloy low carbon wire of the 309LMo type, primarily designed for surfacing low-alloy steels and for welding dissimilar joints between stainless and mild or low-alloy steels. It is also suitable for welding steels like durostat® and alform®. When used for surfacing, a composition equivalent to that of 1.4401/ASTM 316 is obtained already in the first layer. Superior to type 316L. When used for overlay welding on mild steel a corrosion resistance equivalent to that of 1.4401/ASTM 316 is obtained already in the first layer.

## Base materials

For welding steels such as

Outokumpu	EN	ASTM	BS	NF	SS
-----------	----	------	----	----	----

Avesta P5 is primarily used when joining molybdenum-alloyed stainless and carbon steels and for surfacing unalloyed or low-alloy steels.

## Typical analysis of the wire (Wt-%)

C	Si	Mn	Cr	Ni	Mo
0,0015	0,35	1,4	21,5	15,0	2,6

Ferrite 8 FN; WRC-92

## Available flux

801, 805

## Mechanical properties of all-weld metal

Heat Treatment	Yield strength 0,2%	Tensile strength	Elongation ( $L_0=5d_0$ )	Impact values in J CVN		
				+20°C:	-40°C:	
801	470	620	31	50	45	
805	410	600	35	60	50	

## Operating data



Polarity = ±

## Dimensions (mm)

2,4	3,2				3,2
-----	-----	--	--	--	-----

# Avesta LDX 2101

SAW Wire

## Classifications

high-alloyed

EN ISO 14343-A

S 23 7 N L

## Characteristics and field of use

Avesta LDX 2101 is designed for welding the duplex stainless steel Outokumpu LDX 2101®. LDX 2101 is a "lean duplex" steel with excellent strength and medium corrosion resistance. The steel is used in many various applications such as bridges, process equipment in desalination, pressure vessel in the pulp/paper industry and transport and storage tanks for chemicals. To ensure the right ferrite balance in the weld metal, Avesta LDX 2101 is over-alloyed with respect to nickel. The weldability of duplex steels is excellent but the welding should be adapted to the base material, considering fluidity, joint design, heat input etc. Good resistance to general corrosion. Better resistance to pitting, crevice corrosion and stress corrosion cracking than 1.4301/AISI 304.

## Base materials

For welding steels such as

Outokumpu	EN	ASTM	BS	NF	SS
LDX 2101®	1.4162	S32101	-	-	-

## Typical analysis the wire (Wt-%)

C	Si	Mn	Cr	Ni	Mo	N
0,02	0,50	0,8	23,0	7,0	0,5	0,14

Ferrite 45 FN; WRC-92

## Available flux

805

## Mechanical properties of all-weld metal

Heat Treatment	Yield strength 0,2%	Tensile strength	Elongation (L <sub>0</sub> =5d <sub>0</sub> )	Impact values in J CVN		
	MPa	MPa	%	+20°C:	-40°C:	
805	550	700	28	90	40	

## Operating data



Polarity = ±

## Dimensions (mm)

2,4	3,2				
-----	-----	--	--	--	--

<b>Classifications</b>	high-alloyed	
EN ISO 14343	AWS A5.9	
S 25 9 4 N L	ER2594	

## Characteristics and field of use

Avesta 2507/P100Cu/W is intended for welding super duplex alloys such as 2507, ASTM S32760, S32550 and S31260. It can also be used for welding duplex type 2205 if extra high corrosion resistance is required, e.g. in root runs in tubes. The weldability of duplex and super duplex steels is excellent but the welding should be adapted to the base material, considering fluidity, joint design, heat input etc. Very good resistance to pitting and stress corrosion cracking in chloride containing environments. PREW 46. Meets the corrosion test requirements per ASTM G48 Methods A, B and E (40°C).

## Base materials

For welding steels such as					
Outokumpu	EN	ASTM	BS	NF	SS
2507	1.4410	S32750	-	Z3 CDN 25-06 Az	2328

## Typical analysis of the wire (Wt-%)

C	Si	Mn	Cr	Ni	Mo	N
0,02	0,35	0,4	25,0	9,5	4,0	0,25

Ferrite 50 FN; WRC-92

## Available flux

805

## Mechanical properties of all-weld metal

Heat Treatment	Yield strength 0,2%	Tensile strength	Elongation ( $L_0=5d_0$ )	Impact values in J CVN		
	MPa	MPa	%	+20°C:	-46°C:	
805	600	800	27	80	60	

## Operating data

	Polarity = ±	
---	--------------	--

## Dimensions (mm)

2,4	3,2				
-----	-----	--	--	--	--

**BÖHLER CN 13/4-UP/ BÖHLER BB 203**

SAW Wire

**Classifications**

high-alloyed

EN ISO 14343-A:

AWS A5.9:

S 13 4

ER410NiMo (mod.)

**Characteristics and field of use**

Wire/flux combination for same-type corrosion-resistant, martensitic and martensitic-ferritic rolled, forged and cast steels. Used in the construction of water turbines and compressors, and in the construction of steam power stations. Resistant to water and steam. BÖHLER BB 203 is an agglomerated, fluoride-basic welding flux, and yields well-flowed, smooth weld seams. Good slag detachability and low hydrogen content ( $HD \leq 5 \text{ ml/100 g}$ ). More detailed information about BÖHLER BB 203 can be found in the detailed product datasheet for this welding flux.

**Base materials**

1.4317 GX4CrNi13-4, 1.4313 X3CrNiMo13-4, 1.4407 GX5CrNiMo13-4, 1.4414 GX4CrNiMo13-4  
ACI Gr. CA 6 NM

**Typical analysis of all-weld metal (Wt-%)**

C	Si	Mn	Cr	Ni	Mo
0,015	0,65	0,7	11,8	4,7	0,5

**Mechanical properties of all-weld metal**

Heat Treatment	Yield strength 0,2%	Tensile strength	Elongation ( $L_0=5d_0$ )	Impact values in J CVN		
untreated	( $\geq 500$ )	( $\geq 750$ )	( $\geq 15$ )	( $\geq 50$ )		

**Operating data**

	Polarity = $\pm$	re-drying of sub-arc flux: 300-350°C, min. 2 h
---	------------------	---

Preheating and interpass temperature of thick-walled parts 100-160°C. Heat input max. 15 kJ/cm.  
Tempering at 580-620°C.

**Dimensions (mm)**

2,0	2,4	3,0		
-----	-----	-----	--	--

**Approvals and certificates**

Wire/flux combination: SEPROZ, CE  
Wire: SEPROZ

**Similar alloy filler metals**

SMAW electrode:	FOX CN 13/4 FOX CN 13/4 SUPRA	Flu cored wire:	CN 13/4-MC CN 13/4-MC (F)
GMAW solid wire:	CN 13/4-IG	GTAW rod:	CN 13/4-IG

ire

S

18

<b>Classifications</b>	high-alloyed	
EN ISO 18274	AWS A5.14	
S NiCr22Mo9Nb	ERNiCrMo-3	

## Characteristics and field of use

Avesta P12 is a nickel base alloy designed for welding 6Mo-steels such as Outokumpu 254 SMO. It is also suitable for welding nickel base alloys type 625 and 825 and for dissimilar welds between stainless or nickel base alloys and mild steel. To minimise the risk of hot cracking when welding fully austenitic steels and nickel base alloys, heat input and interpass temperature must be low and there must be as little dilution as possible from the parent metal. Excellent resistance to general corrosion in various types of acids and to pitting, crevice corrosion and stress corrosion cracking in chloride containing environments. Meets the corrosion test requirements per ASTM G48 Methods A, B and E (50°C).

## Base materials

For welding steels such as					
Outokumpu	EN	ASTM	BS	NF	SS
254 SMO®	1.4547	S31254	-	-	2378
20-25-6	1.4529	N08926	-	-	-

## Typical analysis of the wire (Wt-%)

C	Si	Mn	Cr	Nb	Fe	Ni	Mo
0,01	0,2	0,1	22,0	3,5	1,0	bal.	9,0

Ferrite 0 FN

## Available flux

805

## Mechanical properties of all-weld metal

Heat Treatment	Yield strength 0,2%	Tensile strength	Elongation ( $L_0=5d_0$ )	Impact values in J CVN		
	MPa	MPa	%	+20°C:	-40°C:	
805	470	730	41	90	80	

## Operating data

	Polarity = ±	
---	--------------	--

## Dimensions (mm)

2,4	3,2				
-----	-----	--	--	--	--

# Thermanit 625

SAW Wire

<b>Classifications</b>	high-alloyed	
EN ISO 18274	AWS A5.14	
S Ni 6625 (NiCr22Mo9Nb)	ERNiCrMo-3	

## Characteristics and field of use

Joints of austenitic-ferritic steels, dissimilar joints of stainless steels, heat resistant, creep resistant and cryogenic steels

## Base materials

2.4856 NiCr22Mo9Nb, 2.4858 NiCr21Mo, 2.4816 NiCr15Fe, 1.4583 X10CrNiMoNb18-12, 1.4876 X10NiCrAlTi32-21, 1.4529 X1NiCrMoCuN25-20-7, X2CrNiMoCuN20-18-6, 2.4641 NiCr21Mo6Cu-Dissimilar joints of the steels above with unalloyed and low alloyed steels like P265GH, P285NH, P295GH, 16Mo3, S355N, X8Ni9, ASTM A 553 Gr.1, B443, B446, UNS N06625 N 08926, Alloy 600, Alloy 625, Alloy 800, steels with 9% Ni

## Typical analysis of the wire (Wt-%)

C	Si	Mn	Cr	Mo	Ni	Fe	Nb
0,015	0,15	0,2	22,0	9,0	bal.	0,5	3,6

## Available flux

Marathon 444

## Mechanical properties of all-weld metal

Heat Treatment	Yield strength 0,2%	Tensile strength	Elongation ( $L_0=5d_0$ )	Impact values in J CVN		
	MPa	MPa	%	RT		
untreated	≥ 420	≥ 700	≥ 40	≥ 80		

## Operating data

	Polarity = ±	
---	--------------	--

## Dimensions (mm)

1,6	2,0	2,4			
-----	-----	-----	--	--	--

## Approvals and certificates

# UTP UP 6222 Mo UTP UP FX 6222 Mo

SAW Wire

Classifications	high-alloyed	
EN ISO 18274	AWS A5.14	
S Ni 6625 (NiCr22Mo9Nb)	ER NiCrMo-3	

## Characteristics and field of use

UTP UP 6222 Mo and the flux UTP UP FX 6222 Mo are applied for joint welding of base materials with the same or with a similar composition, e. g. Alloy 625 (UNS N06625) or NiCr22Mo9Nb, Material-No. 2.4856 or mixed combinations with stainless steels and carbon steels. Furthermore the wire-flux combination is used for cold-tough Ni-steels, e. g. X8Ni9 for LNG projects. UTP UP 6222 Mo / UTP UP FX 6222 Mo is also applied on alloyed or unalloyed steels for cladding of corrosion resistant plants.

## Base materials

2.4856 NiCr22Mo9Nb, 2.4858 NiCr21Mo, 2.4816 NiCr15Fe, 1.4583 X10CrNiMoNb18-12, 1.4876 X10NiCrAlTi32-21, 1.4529 X1NiCrMoCuN25-20-7, X2CrNiMoCuN20-18-6, 2.4641 NiCr21Mo6Cu-Dissimilar joints of the steels above with unalloyed and low alloyed steels like P265GH, P285NH, P295GH, 16Mo3, S355N, X8Ni9, ASTM A 553 Gr.1, B443, B446, UNS N06625 N 08926, Alloy 600, Alloy 625, Alloy 800, steels with 9% Ni

## Typical analysis of all-weld metal (Wt-%)

C	Si	Cr	Mo	Ni	Nb	Fe
0.02	0.2	21,0	9,0	balance	3,3	2,0

## Mechanical properties of all-weld metal

Heat Treatment	Yield strength 0,2%	Tensile strength	Elongation ( $L_0=5d_0$ )	Impact values in J CVN		
	MPa	MPa	%	+20°C:	-196°C:	
untreated	460	725	40	80	65	

## Operating data

	Polarity = ±	The welding area has to be free from impurities (oil, paint, markings etc.). Welding must be performed with a low heat input. The maximum interpass temperature is at 150° C. Flux has to be re-dried prior to welding: 2 hours at 300 - 400° C. Flux height: approx. 25 mm Stick out: approx. 25 mm
--	--------------	--

## Dimensions (mm)

1,6	2,0	2,4	3,2		
-----	-----	-----	-----	--	--

## Approvals and certificates

TÜV (No. 03918)



**Thermanit Micro 82**

SAW Wire

**Classifications**

high-alloyed

EN ISO 18274

AWS A5.14

S Ni 6082 (NiCr20Mn3Nb)

ERNiCr-3

**Characteristics and field of use**

Joints of austenitic-ferritic steels, dissimilar joints of stainless steels, heat resistant, creep resistant and cryogenic steels

**Base materials**

2.4816 NiCr15Fe, 2.4817 LC- NiCr15Fe, Alloy 600, Alloy 600 L

**Typical analysis of the wire (Wt-%)**

C	Si	Mn	Cr	Ni	Nb	Fe
0,02	0,2	3,2	20,5	bal.	2,6	≥ 2

**Available flux**

Marathon 104

**Mechanical properties of all-weld metal**

Heat Treatment	Yield strength 0,2%	Tensile strength	Elongation ( $L_0=5d_0$ )	Impact values in J CVN		
	MPa	MPa	%	RT		
untreated	≥ 380	≥ 600	≥ 35	≥ 100		

**Operating data**

	Polarity = ±	
---	--------------	--

**Dimensions (mm)**

2,0	2,4	3,2			
-----	-----	-----	--	--	--

ire

S

22

# Thermanit Nimo C 276

SAW Wire

<b>Classifications</b>	high-alloyed	
EN ISO 18274	AWS A5.14	
S Ni 6276 (NiCr15Mo16Fe6W4)	ERNiCrMo-4	

## Characteristics and field of use

Vessels and construction of chemical apparatus, especially for low temperatures application down to -163°C e.g. LNG tanks.

The weld metal is stainless and corrosion resistant to reducing and oxidating substances.

## Base materials

2.4819 NiMo16Cr15W UNS N10276

## Typical analysis of the wire (Wt-%)

C	Si	Mn	Cr	Mo	Ni	Fe	W
0,012	0,1	0,5	15,5	16	bal.	7,0	3,8

## Available flux

Marathon 104

## Mechanical properties of all-weld metal

Heat Treatment	Yield strength 0,2%	Tensile strength	Elongation ( $L_0=5d_0$ )	Impact values in J CVN		
	MPa	MPa	%	RT		
untreated	≥ 460	≥ 730	≥ 40	≥ 90		

## Operating data



Polarity = ±

## Dimensions (mm)

2,4						
-----	--	--	--	--	--	--



## Chapter 4.3 - SAW Flux

Product Name	EN ISO	Page
BOHLER BB 418 TT	SA FB 1 55 AC H5	2,3
UV 418 TT	SA FB 1 55 AC H5	3,4,5
UV 421 TT	SA FB 1 55 AC H5	6,7,8
BOHLER BB 24	SA FB 1 65 DC H5	9,10
UV 420 TT	SA FB 1 65 DC / SA FB 1 65 DC H5	11,12,13
UV 420 TTR / UV 420 TTR-W	SA FB 1 65 DC / SA FB 1 65 AC	14,15,16
UV 420 TTR-C	SA FB 1 65 DC	17
UV 310 P	SA AB 1 55 AC H5	18
BOHLER BB 400	SA AB 1 67 AC H5	19
UV 400	SA AB 1 67 AC H5	20, 21
UV 309 P	SA AB 1 65 AC H5	22
UV 305	SA AR 1 76 AC H5	23
UV 306	SA AR 1 77 AC H5	24,25
Avesta FLUX 805	SA AF 2 Cr DC	26
BÖHLER BB 202	SA FB 2 DC	27
Marathon 431	SA FB 2 64 DC	28,29
BÖHLER BB 910	SA FB 2 DC H5	30
Marathon 543	SA FB 2 55 DC H5	31
Avesta FLUX 801	SA CS 2 Cr DC	32

**Classifications**

unalloyed

EN ISO 14174:

SA FB 1 55 AC H5

**Characteristics and field of use**

BÖHLER BB 418 TT is an agglomerated fluoride-basic welding flux for joint and build-up welding of various steels, but particularly suited for high-strength and cryogenic fine-grained structural steels. The flux can be welded using almost any wire electrode. The welding flux can be used with DC or AC power, and can be employed for tandem and multiple wire welding. It features good slag detachability.

**Base materials**

Unalloyed steels, creep resistant and highly creep resistant steels, low-temperature steels, fine-grained structural steels

**Composition of Sub-arc Welding Flux**SiO<sub>2</sub>+TiO<sub>2</sub>

CaO+MgO

Al<sub>2</sub>O<sub>3</sub>+MnOCaF<sub>2</sub>

15

35

20

25

**Operating data**

Polarity = + / -

basicity acc. Boniczewski: 3,5 Mol.% 2,6 weight %  
 grain size acc. EN ISO 14174: 3-20 (0,3-2,0 mm)  
 flux consumption: 1,0 kg flux per kg wire  
 re-drying: 300-350 C, 2 h

**Approvals and certificates**

As wire-flux combination for BÖHLER BB 418 TT together with BÖHLER wires:  
 TÜV-D: EMS 2, EMS 2 Mo, 3 NiMo 1-UP, DB: (51.014.04) EMS 2, EMS 2 Mo,

# BÖHLER BB 4 TT

Typical analysis for wire and weld metal in wt. %:

Designation SAW Wires	C	Si	Mn	Cr	Mo	Ni	EN ISO (wire) EN ISO (wire/flux comb)AWS A5.17 – AWS A5.23
BÖHLER EMS 2	0,07	0,2	0,95				S 2 S 38 5 FB S2 F7A5-EM12K / F48A4-EM12K
BÖHLER EMS 2 Mo	0,07	0,2	0,95		0,45		S 2 Mo S 46 4 FB S2Mo F8A6-EA2-A2 / F55A5-EA2-A2
BÖHLER Ni 2-UP	0,06	0,25	0,95			2,25	S2Ni2 S 46 8 FB S2Ni2 F8A10-ENi2-Ni2 / F55A8-ENi2-Ni2
BÖHLER 3 NiMo 1-UP	0,08	0,25	1,55		0,55	0,9	S3Ni1Mo S 55 6 FB S3Ni1Mo F7A8-EH12K / F48A6-EH12K
BÖHLER 3 NiCrMo 2.5-UP	0,05	0,3	1,3	0,5	0,5	2,2	S3Ni2.5CrMo S 69 6 FB S3Ni2.5CrMo F11A8-EM4 (mod.)-M4H4 / F76A6-EM4 (mod.)-M4H4
BÖHLER EMS 2 CrMo	0,8	0,15	0,9	1,1	0,45		S CrMo1 S S CrMo1 FB F8P2-EB2-B2 / F55P3-EB2-B2
BÖHLER CM 2-UP	0,08	0,2	0,7	2,4	0,95		S CrMo2 S S CrMo2 FB F8P2-EB3-B3 / F55P3-EB3-B3

**Classifications**

unalloyed

EN ISO 14174:

SA FB 1 55 AC H5

**Characteristics and field of use**

UV 418 TT is an agglomerated flux of fluoride basic type for joining and surfacing and applications with dissimilar steels. Mainly for high strength and cryogenic fine grained structural steels. The Si and Mn pick-ups and burn-off rates are neutral because of its metallurgical behaviour.

The flux is weldable with almost every wire electrode. When used in combination with Union S 3 Si wire electrode, the weld metal has high toughness properties up to  $-60\text{ }^{\circ}\text{C}$  ( $-76\text{ }^{\circ}\text{F}$ ) and very good CTOD values up to  $-30\text{ }^{\circ}\text{C}$  ( $-22\text{ }^{\circ}\text{F}$ ), so that this combination is outstandingly suited for offshore constructions. The flux can be used for tandem and multi wire welding with DC and AC.

Very good slag detachability.

**Composition of Sub-arc Welding Flux**SiO<sub>2</sub>+TiO<sub>2</sub>

CaO+MgO

Al<sub>2</sub>O<sub>3</sub>+MnOCaF<sub>2</sub>

15

38

20

25

**Operating data**

Polarity = - / ~

basicity acc. Boniczewski: 3,5 Mol.% 2,6 weight %  
 grain size acc. EN ISO 14174: 3-20 (0,3-2,0 mm)  
 re-drying: 300-350 C, 2 h

Approvals	TÜV	DB	DNV	GL	LR	BV
Union S 2	10410	51.132.05				
Union S 2 Mo	11576	51.132.05				
Union S 2 Ni 2,5	11575					
Union S 3 Si	07276	51.132.05	X	X	X	X

# UV 4 TT

Typical analysis for wire and weld metal in wt. %:

Designation	C	Si	Mn	Cr	Mo	Ni	EN ISO 14171 / EN ISO 26304-A AWS A5.17 – SFA 5.17 AWS A5.23 – SFA 5.23
Union S 2 Weld metal	0,10 0,07	0,10 0,20	1,00 0,95				S 35 4 FB S2 F7A5-EM12
Union S 2 Mo Weld metal	0,10 0,07	0,10 0,20	1,00 0,95		0,50 0,45		S 46 4 FB S2Mo F8A6-EA2-A2
Union S 2 Ni 2,5 Weld metal	0,10 0,07	0,10 0,20	1,00 0,95			2,30 2,20	S 46 8 FB S2Ni2 F8A10-ENi2-Ni2
Union S 2 Ni 3,5 Weld metal	0,09 0,06	0,15 0,20	0,90 0,85			3,30 3,20	S 46 8 FB S2Ni3 F8A15-ENi3-Ni3
Union S 2 NiMo 1 Weld metal	0,11 0,07	0,10 0,20	1,00 0,95		0,25 0,23	0,90 0,85	S 50 6 FB SZ2Ni1Mo F8A10-ENi1-Ni1
Union S 2 Si Weld metal	0,10 0,08	0,30 0,30	1,10 1,10				S 42 5 FB S2Si F7A6-EM12K
Union S 3 Weld metal	0,12 0,08	0,10 0,20	1,50 1,35				S 38 4 FB S3 F7A6-EH10K
Union S 3 Mo Weld metal	0,12 0,08	0,10 0,20	1,50 1,35		0,50 0,45		S 46 4 FB S3Mo F8A5-EA4-A4
Union S 3 NiMo Weld metal	0,08 0,06	0,10 0,20	1,50 1,40		0,45 0,40	1,50 1,40	S 50 6 FB S3Ni1,5Mo F9A8-EG-F1
Union S 3 NiMo 1 Weld metal	0,12 0,08	0,10 0,25	1,60 1,55		0,60 0,55	0,95 0,90	S 50 6 FB S3Ni1Mo F9A8-EG-F3
Union S 3 NiMoCr Weld metal	0,14 0,08	0,10 0,20	1,75 1,50	0,35 0,32	0,60 0,58	2,10 2,00	S 69 6 FB SZ3Ni2,5CrMo F11A8-EG-F6
Union S 3 Si Weld metal	0,10 0,08	0,30 0,30	1,70 1,55				S 46 6 FB S3Si F7A8-EH12K



<b>Classifications</b>	unalloyed	
EN ISO 14174:		
SA FB 1 55 AC H5		

#### Characteristics and field of use

Agglomerated fluoride basic flux with high basicity and neutral metallurgical behaviour. It is suitable for single (DC or AC) and tandem (DC and AC) welding. Very good slag detachability. Excellent for narrow gap welding. UV 421 TT can be used in combination with suitable sub arc wires for joint welding of mild, medium alloyed and high tensile steels. Very good impact toughness of weld metal at low temperatures.

#### Base materials

#### Composition of Sub-arc Welding Flux

SiO <sub>2</sub> +TiO <sub>2</sub>	CaO+MgO	Al <sub>2</sub> O <sub>3</sub> +MnO	CaF <sub>2</sub>	
15	38	20	25	

#### Operating data



Polarity = + / -

basicity acc. Boniczewski: 3,5 Mol.% 2,6 weight %  
 grain size acc. EN ISO 14174: 3-20 (0,3-2,0 mm)  
 re-drying: 300-350 C, 2 h

Approvals	TÜV	ABS	BV	WIWEB	GL	LR	DNV	DB
Union S 2	05497					X		51.132.06
Union S 2 Mo	03344					X		51.132.06
Union S 2 Ni 2,5	02213	X	X		X	X	X	51.132.06
Union S 3	05498					X	X	51.132.06
Union S 3 Si	10424					X	X	
Union S 3 NiMo				X	X			
Union S 3 NiMo1	10425					X	X	
Union S 3 NiMoCr	05063	X	X	X	X	X	X	51.132.06

Typical analysis for wire and weld metal in wt. %:

Designation	C	Si	Mn	Cr	Mo	Ni	EN ISO 14171 EN ISO 26304-A AWS A5.17 – SFA 5.17 •• AWS A5.23 – SFA-5.23
Union S 2 Weld metal	0,10 0,07	0,10 0,20	1,00 1,05				S 35 4 FB S2 F7A6-EM12
Union S 2 Mo Weld metal	0,10 0,07	0,10 0,20	1,00 1,05		0,50 0,47		S 46 4 FB S2Mo F8A4-EA2-A2
Union S 2 Ni 2,5 Weld metal	0,10 0,07	0,10 0,20	1,00 1,05			2,30 2,20	S 46 8 FB S2Ni2 F8A10-ENi2-Ni2
Union S 2 Ni 3,5 Weld metal	0,09 0,06	0,15 0,20	0,90 0,90			3,30 3,20	S 46 8 FB S2Ni3 F8A15-ENi3-Ni3
Union S 2 NiMo 1 Weld metal	0,11 0,08	0,10 0,20	1,00 1,05		0,25 0,22	0,90 0,85	S 50 6 FB SZ2Ni1 F8A8-ENi1-Ni1
Union S 3 Weld metal	0,12 0,08	0,15 0,25	1,50 1,50				S 38 5 FB S3 F7A6-EH10K
Union S 3 NiMo Weld metal	0,08 0,06	0,10 0,20	1,50 1,50		0,45 0,42	1,50 1,45	S 55 6 FB S3Ni1,5Mo F9A8-EG-F1
Union S 3 NiMo 1 Weld metal	0,12 0,08	0,10 0,20	1,60 1,55		0,60 0,55	0,95 0,90	S 55 6 FB S3Ni1Mo F9A8-EG-F3
Union S 3 NiMoCr Weld metal	0,14 0,08	0,10 0,20	1,75 1,60	0,35 0,32	0,60 0,58	2,10 2,00	S 69 6 FB SZ3Ni2,5CrMo F11A8-EG-F6
Union S 3 Si Weld metal	0,10 0,08	0,30 0,30	1,70 1,55				S 46 5 FB S3Si F7A8-EH12K

Mechanical properties of the weld metal, as welded:

Wire electrodes used	Yield strength 0,2%	Tensile strength	Elongation ( $L_0=5d_0$ )	Impact values <i>in</i> $\geq J$ CVN				
				$\geq MPa$	$\geq MPa$	$\geq \%$	+20 °C	$\pm 0$ °C
Union S 2	400	510	26	150	130	100	47	27
Union S 2 Mo	470	560	24	140	120	100	47	
Union S 2 Ni 2,5	470	550	24	160	140	120	80	60
Union S 2 Ni 3,5	470	560	25	160	140	120	100	47
Union S 2 NiMo 1	500	560	24	160	140	120	100	47
Union S 3	420	530	26	150	150	120	60	27
Union S 3 NiMo	560	620	22	140	120	100	80	47
Union S 3 NiMo1	560	640	22	140	120	100	70	47
Union S 3 NiMoCr	690	780	17	120	100	80	60	47
Union S 3 Si	460	550	26	150	120	80	60	47

\* Average values from 3 tests

<b>Classifications</b>	unalloyed	
EN ISO 14174:		
SA FB 1 65 DC H5		

**Characteristics and field of use**

Agglomerated, fluoride-basic welding flux characterised by its neutral metallurgical behaviour. In combination with suitable wire electrodes, the weld metal exhibits exceptional toughness properties in the low temperature range. The field of application is joint and build-up welding of general structural steels, fine-grained structural steels and creep resistant steel grades. The flux is one of the hydrogen controlled fluxes; the diffusible hydrogen content is max. 5 ml/100 g of weld metal.

**Base materials**

unalloyed steels, creep resistant and highly creep resistant steels, low-temperature steels, fine-grained steels

**Composition of Sub-arc Welding Flux**

SiO <sub>2</sub> +TiO <sub>2</sub>	CaO+MgO	Al <sub>2</sub> O <sub>3</sub> +MnO	CaF <sub>2</sub>	
15	35	21	26	

**Operating data**

	Polarity = + / ~	basicity acc. Boniczewski:	3,4 Mol.%	2,5 weight %
		bulk density:	1,0 kg/dm <sup>3</sup>	
		grain size acc. EN ISO 14174:	3-25 (0,3-2,5 mm)	
		flux consumption:	1,0 kg flux per kg wire	
		re-drying:	300-350 C, 2 h	

**Approvals and certificates**

DB (51.014.02), ÖBB, NAKS; As wire-flux combination BÖHLER BB 24 together with BÖHLER wires: TÜV-D: EMS 2, EMS 2 Mo, EMS 2 CrMo, CM 2-UP, 3 NiMo 1-UP

## BÖHLER BB 4

Typical analysis for wire and weld metal in wt. %:

Designation SAW Wires	C	Si	Mn	Cr	Mo	Ni	EN ISO (wire) EN ISO (wire/flux comb)AWS A5.17 – AWS A5.23
BÖHLER EMS 2	0,07	0,25	1,2				S 2 S 38 6 FB S2 F7A8-EM12K / F48A6-EM12K
BÖHLER EMS 2 Mo	0,07	0,25	1,15		0,45		S 2 Mo S 46 4 FB S2Mo F8A4-EA2-A2 / F55A4-EA2-A2
BÖHLER Ni 2-UP	0,07	0,25	1,15			2,2	S2Ni2 S 46 6 FB S2Ni2 F8A8-ENi2-Ni2 / F55A6-ENi2-Ni2
BÖHLER 3 NiMo 1-UP	0,09	0,25	1,65		0,55	0,9	S3Ni1Mo S 50 4 FB S3Ni1Mo F9A4-EF3-F3 / F62A4-EF3-F3
BÖHLER 3 NiCrMo 2.5-UP	0,06	0,3	1,5	0,5	0,5	2,2	S3Ni2.5CrMo S 69 6 FB S 3Ni2.5CrMo F11A8-EM4(mod)-M4 / F76A6-EM4(mod)-M4
BÖHLER EMS 2 CrMo	0,08	0,25	0,95	1,1	0,45		S CrMo1 - F8P2-EB2-B2 / F55P3-EB2-B2
BÖHLER CM 2-UP	0,08	0,25	0,75	2,4	0,95		S CrMo2 - F8P2-EB3-B3 / F55P3-EB3-B3

**Classifications**

unalloyed

EN ISO 14174:

SA FB 1 65 DC / SA FB 1 65 DC H5

**Characteristics and field of use**

UV 420 TT is an agglomerated flux of fluoride basic type for joining and surfacing applications with general purpose structural steels, fine grained structural steels and creep resistant steels. It is characterized by its neutral metallurgical behaviour. When used in combination with suitable wire electrodes the weld metal has high toughness properties at subzero temperatures. It is suited for single wire and tandem welding.

**Composition of Sub-arc Welding Flux**

SiO <sub>2</sub> +TiO <sub>2</sub>	CaO+MgO	Al <sub>2</sub> O <sub>3</sub> +MnO	CaF <sub>2</sub>	
15	35	21	26	

**Operating data**

	Polarity = - / ~	basicity acc. Boniczewski: 3,4 Mol.% grain size acc. EN ISO 14174: 3-20 (0,3-2,0 mm) re-drying: 300-350 C, 2 h	2,5 weight %
---	------------------	--	--------------

Approvals:	TÜV	DB
Union S 2	03358	51.132.02
Union S 2 CrMo	01794	
Union S 2 Mo	01793	
Union S 3	01795	
Union S 3 Mo	01796	
Union S 3 NiMo	01797	
Union S 3 NiMo 1	03020	
Union S 3 NiMoCr	02206	

## Typical analysis for wire and weld metal in wt. %:

Designation	C	Si	Mn	Cr	Mo	Ni	V	W	Cu	EN ISO 14171 EN ISO 26304-A EN ISO 24598-A AWS A5.17 – SFA 5.17 •• AWS A5.23 – SFA 5.23
Union S 2 Weld metal	0,10 0,07	0,10 0,25	1,00 1,05							S 35 4 FB S2 F7A4-EM12
Union S 2 Mo Weld metal	0,10 0,07	0,10 0,25	1,00 1,05		0,50 0,45					S 46 4 FB S2Mo F8A4-EA2-A2
Union S 3 Weld metal	0,12 0,08	0,10 0,25	1,50 1,50							S 38 4 FB S3 F7A4-EH10K
Union S 3 Mo Weld metal	0,12 0,08	0,10 0,25	1,50 1,50		0,50 0,45					S 46 4 FB S3Mo F8A4-EA4-A4
Union S 1 CrMo 2 Weld metal	0,10 0,07	0,10 0,25	0,50 0,75	2,40 2,25	1,00 0,95					S S CrMo2 FB F9P0-EB3R-B3
Union S 2 CrMo Weld metal	0,12 0,08	0,10 0,25	0,80 0,95	1,20 1,10	0,50 0,45					S S CrMo1 FB F8P0-EB2R-B2
Union S 2 Ni 2,5 Weld metal	0,10 0,07	0,10 0,25	1,00 1,05			2,50 2,40				S 46 6 FB S2Ni2 F8A8-ENI2-NI2
Union S 3 NiMo Weld metal	0,08 0,06	0,10 0,25	1,50 1,50		0,45 0,40	1,50 1,40				S 50 6 FB S3Ni1,5Mo F9A8-EG-F1
Union S 3 NiMo 1* Weld metal	0,12 0,08	0,10 0,25	1,60 1,55		0,60 0,55	0,95 0,90				S 50 6 FB S3Ni1Mo F9A8-EG-F3
Union S 3 NiMoCr Weld metal	0,14 0,08	0,10 0,25	1,70 1,55	0,35 0,32	0,60 0,58	2,10 2,00				S 69 4 FB SZ3Ni2,5CrMo F11A6-EG-F6

\* Tramp elements Co and Ta, in conformity with regulations on reactor construction

## UV 4 0 TT

Mechanical properties of the weld metal, as welded:

Wire electrodes used	Yield strength 0,2%	Tensile strength	Elongation ( $L_0=5d_0$ )	Impact values in $\geq J$ CVN			
				$\geq MPa$	$\geq MPa$	$\geq \%$	+20 °C
Union S 2	400	510	26	160	140	100	47
Union S 2 Mo	470	550	24	140	120	80	47
Union S 2 Ni 2,5	470	550	24	160	140	100	47
Union S 3	400	510	26	160	140	100	47
Union S 3 Mo	470	550	24	140	120	80	47
Union S 3 NiMo	560	620	22	160	140	80	47
Union S 3 NiMo 1	560	620	20	160	140	80	47
Union S 3 NiMoCr	690	760	17	100	80	60	47

\* Average values from 3 tests



**Classifications**

unalloyed

EN ISO 14174:

SA FB 1 65 DC / SA FB 1 65 AC

**Characteristics and field of use**

UV 420 TTR is an agglomerated flux of fluoride basic type, mainly for joining and surfacing applications with creep resistant steels. It displays neutral metallurgical behaviour and is characterised by a high degree of purity. It is particularly suitable for welding hydrocrackers because of the low P pick-up of 0.004 % max. When used in combination with wire electrodes Union S 2 CrMo and Union S 1 CrMo 2 it is possible to meet the most stringent toughness requirements at subzero temperatures even after step-cooling treatment. UV 420 TTR-W permits sound welding on AC, by this achieving a higher level of toughness when welding with CrMo-alloyed sub arc wires.

**Composition of Sub-arc Welding Flux**

SiO <sub>2</sub> +TiO <sub>2</sub>	CaO+MgO	Al <sub>2</sub> O <sub>3</sub> +MnO	CaF <sub>2</sub>	
15	35	21	26	

**Operating data**

	Polarity = - / ~	basicity acc. Boniczewski: 3,4 Mol.% grain size acc. EN ISO 14174: 3-20 (0,3-2,0 mm) re-drying: 300-350 C, 2 h	2,5 weight %
---	------------------	--	--------------

**Approvals**

TÜV

LR

Union S 1 CrMo 2\*

06541

Union S 1 CrMo 2

02734

Union S 2

03437

Union S 2 CrMo

03439

Union S 2 Mo

03438

Union S 3

03440

X

Union S 3 Mo

03441

Union S 3 NiMo

03442

Union S 3 NiMo 1

03021 / 08015

Union S 3 NiMoCr

03443

\* with UV 420 TTR-W, all others only with UV 420 TTR.

## UV 4 0 TTR UV 4 0 TTR-

Typical analysis for wire and weld metal in wt. %:

Designation	C	Si	Mn	Cr	Mo	Ni	EN ISO 14171 EN ISO 24598-A AWS A5.23 – SFA-5.23
Union S 1 CrMo 2 Weld metal	0,10 0,07	0,10 0,20	0,50 0,75	2,40 2,25	1,00 0,95		S S CrMo2 FB F9P2-EB3R-B3R
Union S 2 CrMo Weld metal	0,12 0,08	0,10 0,20	0,80 1,00	1,20 1,10	0,50 0,45		S S CrMo1 FB F8P2-EB2R-B2
Union S 2 Mo Weld metal	0,10 0,07	0,10 0,20	1,00 1,05		0,50 0,45		S 46 4 FB S2Mo F8A4-EA2-A2
Union S 3 NiMo Weld metal	0,08 0,05	0,10 0,20	1,50 1,50		0,45 0,40	1,50 1,40	S 50 6 FB S3Ni1,5Mo F9A8-EG-F1
Union S 3 NiMo 1 Weld metal	0,12 0,08	0,10 0,20	1,60 1,55		0,60 0,55	0,95 0,90	S 50 4 FB S3Ni1Mo F9A6-EF3-F3-N

Mechanical properties of the weld metal, as welded:

Wire electrodes used	Yield strength 0,2%	Tensile strength	Elonga- tion ( $L_0=5d_0$ )	Impact values in $\geq J CVN$				
				$\geq MPa$	$\geq MPa$	$\geq \%$	+20 °C	$\pm 0$ °C
Union S 2 Mo	470	550	25	140	120	100	47	
Union S 3 NiMo	560	660	22	140	120	100	47	47
Union S 3 NiMo 1	560	680	22	140	120	100	47	27

\* Average values from 3 tests

## UV 4 0 TTR UV 4 0 TTR-

Mechanical properties of the weld metal of different heat treatments and test temperatures:

Wire electrodes used	Heat Treatment	Test temperature 350°C*			Test temperature 550°C		
		Yield strength 0,2%	Tensile strength	Elongation ( $L_0=5d_0$ )	Yield strength 0,2%	Tensile strength	Elongation ( $L_0=5d_0$ )
		≥ MPa	≥ MPa	≥ %	≥ MPa	≥ MPa	≥ %
Union S 1 CrMo 2	a*	380 <sup>+</sup>	500 <sup>+</sup>	20 <sup>+</sup>	270	360	26
Union S 2 CrMo	a* n + a*	380 200	540 440	22 19	280 180	420 340	26 24
Union S 2 Mo	s n + a	370 220	570 420	24 25	280 170	380 310	26 30
Union S 3 NiMo	s n + a	450 320	600 510	20 25	320 220	410 350	24 28
Union S 3 NiMo 1	s so	420 <sup>++</sup> 420 <sup>++</sup>	590 <sup>++</sup> 580 <sup>++</sup>	24 <sup>++</sup> 24 <sup>++</sup>	290 190	410 330	25 32

a = tempered, 580 – 620 °C/Luft

a\* = tempered, 670 – 700 °C

s = stress relieved, 580 – 620 °C

so = 60 h 550 °C + 40 h 620 °C/air

n = normalized, 920 °C/Luft

\* = Average values from 3 tests

+ = Values at test temperature 450 °C

\*\* = Values at test temperature 400 °C

# UV 4 0 TTRC

SAW Flux

## Classifications

unalloyed

EN ISO 14174:

SA FB 1 65 DC

## Characteristics and field of use

UV 420 TTRC is an agglomerated fluoride-basic flux with high basicity and neutral metallurgical behaviour. UV 420 TTRC is a special variant of flux UV 420 TTR. It supports the C-content of the wire electrode when DC-welding. In comparison with UV 420 TTR the C-content in the all weld metal is about 0.03 - 0.04 % higher. It is suitable for multipass welding, for single- and tandem-wire systems. UV 420 TTRC has prime importance for SAW of the high-temperature resistant steel, for joining and surfacing applications.

## Composition of Sub-arc Welding Flux

SiO<sub>2</sub>+TiO<sub>2</sub>

CaO+MgO

Al<sub>2</sub>O<sub>3</sub>+MnO

CaF<sub>2</sub>

15

35

21

26

## Operating data



Polarity = - / ~

basicity acc. Boniczewski: 3,4 Mol.% 2,5 weight %  
 grain size acc. EN ISO 14174: 3-20 (0,3-2,0 mm)  
 re-drying: 300-350 C, 2 h

Weld metal with

AWS A5.23

EN ISO 26304-A

Union S 3 NiMo1

F10A6-EF3-F3

S 62 6 FB S3Ni1Mo

**Classifications**

unalloyed

EN ISO 14174:

SAAB 1 55 AC H5

**Characteristics and field of use**

UV 310 P is an agglomerated aluminate-basic flux with high basicity and neutral metallurgical behaviour. It is suitable for single electrode (DC+), twin electrodes (DC+) and tandem electrodes (DC+ and AC) welding. The flux is especially suited for Mn-, Mo-, Ti, and B or Mn-, Ti and B-alloyed wire electrodes like Union S 3 MoTiB and Union S 3 TiB. It is suited to achieve optimal characteristics for the toughness of the weld metal.

UV 310 P is suitable for the welding of pipe steels according to API X 60, X 65, X 70, X 80 or acc. to EN 10208-2: L415 MB, L450 MB, L485 MB and L555 MB.

**Note:**

The mechanical-technological behaviour of the weld metal produced by the two-run technique (mainly the toughness) is not only influenced by the wire-/flux-combination but by many other factors such as:

the influence of chemical composition of the parent metal due to the high dilution (60 up to 70%)

the influence of the relative long cooling time  $t_{8/5}$  from the

welding heat by:

- welding parameter (heat input)
- wall thickness (two resp. three dimensional heat flow)
- preheat and interpass temperature

**Composition of Sub-arc Welding Flux**

SiO <sub>2</sub> +TiO <sub>2</sub>	CaO+MgO	Al <sub>2</sub> O <sub>3</sub> +MnO	CaF <sub>2</sub>
18	25	32	18

**Operating data**

	Polarity = + / -	basicity acc. Boniczewski: 2,2 Mol. % grain size acc. EN ISO 14174: 3-20 (0,3-2,0 mm) re-drying: 350-400 C, 2 h	1,5 weight %
---	------------------	---	--------------

# BÖHLER BB 400

SAW Flux

## Classifications

unalloyed

EN ISO 14174:

SAAB 1 67 AC H5

## Characteristics and field of use

BÖHLER BB 400 is an agglomerated welding flux of the aluminate-basic type for joint and buildup welding of general structural steels, fine-grained structural steels, boiler and pipe steels. The welding flux is characterised by low silicon pick-up and medium manganese pick-up. BÖHLER BB 400 can be welded using DC or AC power. Its good welding properties, and the good technical properties of the weld metals that can be achieved with different wire electrodes permit universal application.

## Base materials

General structural steels, fine-grained structural, boiler and pipe steels.

## Composition of Sub-arc Welding Flux

SiO <sub>2</sub> +TiO <sub>2</sub>	CaO+MgO	Al <sub>2</sub> O <sub>3</sub> +MnO	CaF <sub>2</sub>
20	30	28	16

## Operating data

	Polarity = + / - / -	basicity acc. Boniczewski:	2,3 Mol.%	1,7 weight %
		grain size acc. EN ISO 14174:	3-20 (0,3-2,0 mm)	
		flux consumption:	1,0 kg flux per kg wire	
		re-drying:	300-350 C, 2 h	

## Typical analysis for wire and weld metal in wt. %:

Designation SAW Wires	C	Si	Mn	Cr	Mo	Ni	EN ISO (wire) EN ISO (wire/flux comb)AWS A5.17 – AWS A5.23
BÖHLER EMS 2	0,06	0,35	1,35				S 2 S 38 AB S2 F7A4-EM12K / F48A4-EM12K
BÖHLER EMS 2 Mo	0,06	0,35	1,35		0,35		S 2 Mo S 46 4 AB S2Mo F8A4-EA2-A4 / F55A4-EA2-A4

## Approvals and certificates

DB (51.014.03)

As wire-flux combination BÖHLER BB 400 together with BÖHLER wires:

TÜV-D: EMS 2, EMS 2 Mo

DB: EMS 2, EMS 2 Mo

<b>Classifications</b>	unalloyed	
EN ISO 14174:		
SAAB 1 67 AC H5		

#### Characteristics and field of use

UV 400 is an agglomerated flux of aluminate basic type designed for joining and surfacing applications with general-purpose structural steels, fine grained structural steels, boiler and pipe steels. The flux is characterized by its low silicon and moderate manganese pickup. It can be used on DC and AC. Its good welding characteristics and the technological properties of the weld metal produced with different wires permit universal use.

#### Composition of Sub-arc Welding Flux

SiO <sub>2</sub> +TiO <sub>2</sub>	CaO+MgO	Al <sub>2</sub> O <sub>3</sub> +MnO	CaF <sub>2</sub>	
20	30	28	16	

#### Operating data

	Polarity = - / ~	basicity acc. Boniczewski:	2,3 Mol.%	1,7 weight %
		grain size acc. EN ISO 14174:	3-20 (0,3-2,0 mm)	
		re-drying:	300-350 C, 2 h	

#### Typical analysis for wire and weld metal in wt. %:

Designation	C	Si	Mn	Mo	EN ISO 14171 AWS A5.17 – SFA 5.17 AWS A5.23 – SFA 5.23
Union S 2 Weld metal	0,10 0,06	0,10 0,35	1,00 1,35		S 38 4 AB S2 F7A4-EM12
Union S 2 Mo Weld metal	0,10 0,06	0,10 0,35	1,00 1,35	0,50 0,45	S 46 4 AB S2Mo F8A4-EA2-A2
Union S 2 Si Weld metal	0,10 0,06	0,30 0,35	1,00 1,50		S 42 4 AB S2Si F7A4-EM12K
Union S 3 Weld metal	0,12 0,07	0,10 0,35	1,50 1,60		S 42 4 AB S3 F7A4-EH10K

## UV 400

Mechanical properties of the weld metal, as welded:

Wire electrodes used	Con- dition	Yield strength	Tensile strength	Elongation	Impact values			
		0,2%		( $L_0=5d_0$ )	in $\geq J$ CVN			
		$\geq MPa$	$\geq MPa$	$\geq \%$	+20 °C	$\pm 0$ °C	-20 °C	-40 °C
Union S 2	u	400	480	22	120	100	60	47
	s	355	480	25	140	120	100	47
	n	290	460	22	80	60	47	
Union S 2 Mo	u	470	550	22	100	90	47	47
	s	470	550	22	100	100	60	47
Union S 2 Si	u	420	500	22	100	80	47	47
	s	355	480	25	140	120	80	47
Union S 3	u	420	500	22	120	120	60	47
	s	380	500	25	140	120	100	47

\* Average values from 3 tests

u = as welded

s = stress relieved: 580 °C / 5 h / air

n = normalized: 920 °C / 1 h / air

Approvals	TÜV	DB	ABS	BV	GL	LR	DNV
Union S 2	06170	51.132.03	X	X	X	X	X
Union S 2 Mo	06233	51.132.03	X	X	X	X	X



**Classifications**

unalloyed

EN ISO 14174:

SAAB 1 65 AC H5

**Characteristics and field of use**

UV 309 P is an agglomerated flux of the aluminate basic type with neutral metallurgical behaviour. It is especially suited for welding single and multi wire (DC and AC) when manufacturing longitudinal and spiral-seam pipes with two-run technique. For the two-run welding of pipe steels of API Grade A 25, A, B, X 42, X 46, X 52, X 56, X 60, X 65, X 70, X 80 and according to EN 10208-2 L290MB up to L555MB if welded in combination with corresponding sub arc wires such as Union S 2, Union S 2 Mo, Union S 2 NiMo1, Union S 3 NiMo 1.

**Note:**

The mechanical-technological behaviour of the weld metal produced by the two-run technique (mainly the toughness) is not only influenced by the wire-/flux-combination but by many other factors such as:

- the influence of chemical composition of the parent metal due to the high dilution (60 up to 70%)
- the influence of the relative long cooling time  $t_{8/5}$  from the welding heat by:
  - welding parameter (heat input)
  - wall thickness (two resp. three dimensional heat flow)
  - preheat and interpass temperature

**Composition of Sub-arc Welding Flux**

SiO <sub>2</sub> +TiO <sub>2</sub>	CaO+MgO	Al <sub>2</sub> O <sub>3</sub> +MnO	CaF <sub>2</sub>	
22	26	30	15	

**Operating data**

	Polarity = - / ~	basicity acc. Boniczewski: 2,1 Mol.% 1,4 weight % grain size acc. EN ISO 14174: 3-20 (0,3-2,0 mm) re-drying: 350-400 C, 2 h
---	------------------	---

**Classifications**

unalloyed

EN ISO 14174:

SAAR 1 76 AC H5

**Characteristics and field of use**

UV 305 is an agglomerated flux of aluminate-rutile type for joining and surface welding. Suited for direct and alternating current. The flux is suited for butt welding in two-run technique and for sheet thickness up to 10 mm for fillet welding. It is especially suited for welding tube walls.

**Suited sub-arc wires:**

Union S 2, S 2 Si, S 2 Mo and for boiler walls also Union S 2 CrMo, S 1 CrMo 2, Union S P24. It has outstanding good slag detachability (even in narrow grooves) and allows high welding speed.

**Composition of Sub-arc Welding Flux**

SiO <sub>2</sub> +TiO <sub>2</sub>	Al <sub>2</sub> O <sub>3</sub> +MnO	CaF <sub>2</sub> +CaO+ MgO	
30	55	8	

**Operating data**

	Polarity = - / ~	basicity acc. Boniczewski: 0,7 Mol.%      0,6 weight %
		grain size acc. EN ISO 14174: 4 - 14 (0,4-1,4 mm)
		re-drying: 300-350 C, 2 h

**TÜV approvals (for membrane walls)**

Union S 2 Mo, Union S 2 CrMo, Union S 1 CrMo2, Union SP 24

<b>Classifications</b>	unalloyed	
EN ISO 14174:		
SAAR 1 77 AC H5		

#### Characteristics and field of use

UV 306 is an agglomerated flux designed for joining applications on general-purpose structural and pipe steels. Suitable for use on DC and AC. For single- and multi-wire welding with high welding speed using the two-run technique as well as for fillet welding. Very good slag removability.

#### Composition of Sub-arc Welding Flux

SiO <sub>2</sub> +TiO <sub>2</sub>	Al <sub>2</sub> O <sub>3</sub> +MnO	CaF <sub>2</sub> + CaO+MgO	
24	50	14	

#### Operating data

	Polarity = - / ~	basicity acc. Boniczewski:	0,8 Mol.%	0,6 weight %
		grain size acc. EN ISO 14174:	3 - 16 (0.3 - 1.6 mm)	
		re-drying:	300-350 C, 2 h	

#### Typical analysis for wire and weld metal in wt. %:

Designation	C	Si	Mn	Mo	EN ISO 14171 AWS A5.17 – SFA 5.17 AWS A5.23 – SFA 5.23
Union S 2 Weld metal	0,10 0,06	0,10 0,60	1,00 1,40		S 42 3 AR S2 F7A2-EM12
Union S 2 Mo Weld metal	0,10 0,06	0,10 0,60	1,00 1,40	0,50 0,45	S 46 2 AR S2Mo F8A2-EA2-A2
Union S 2 Si Weld metal	0,10 0,06	0,30 0,75	1,00 1,60		S 42 2 AR S2Si F7A2-EM12K
Union S 3 Weld metal	0,12 0,07	0,10 0,60	1,50 1,60		S 42 3 AR S3 F7A2-EH10K

Mechanical properties of the weld metal, as welded:

Wire electrodes used	Yield strength 0,2%	Tensile strength	Elongation ( $L_0=5d_0$ )	Impact values in $\geq J CVN$			
				$\geq MPa$	$\geq MPa$	$\geq \%$	+20°C
Union S 2	420	530	22	80	60	47	47
Union S 2 Mo	470	550	22	70	60	47	28
Union S 2 Si	420	540	22	70	50	47	28
Union S 3	420	520	22	80	60	47	47

\* Average values from 3 tests

Approvals	TÜV	DB	ABS	GL	LR	DNV
Union S 2	02590	51.132.04	X	X	X	X
Union S 2 Mo	07739					
Union S 2 Si					X	

<b>Classifications</b>	high-alloyed	
EN ISO 14174:		
SAAF 2 Cr DC		

#### Characteristics and field of use

Avesta Flux 805 is a basic, slightly chromiumcompensated agglomerated flux. It is primarily designed for welding with high-alloyed stainless fillers such as Avesta P12, 904L and 2205. Standard Cr-Ni and Cr-Ni-Mo fillers can also be welded with excellent results. Flux 805 is especially suitable for applications where high impact strength values are required. Flux 805 provides neat weld surfaces, very good welding properties and easy slag removal.

- Bulk density: 1.0 kg/dm<sup>3</sup>
- Basicity index: 1.7 (Boniszewski)
- Consumption: 0.5 kg flux/kg wire (26 V) 0.8 kg flux/kg wire (34 V)

#### Flux care

The flux should be stored indoors in a dry place. Moist flux can be redried at 250 – 300°C for 2 hours. Both heating and cooling must be carried out slowly.

#### Basic materials

For welding with submerged arc wire such as Avesta Welding LDX 2101, 2304, 2205, 2507/P100, 904L, P12 and P16, but also with 308L/MVR, 347/MVNb, 316L/SKR, 318/SKNb, 309L and P5

#### Typical analysis for wire and weld metal in wt. %:

Designation	C	Si	Mn	Cr	Ni	Mo	FN*
316L/SKR	0,02	0.6	1,2	19,5	12,0	2,6	11
2205	0,02	0.7	1,0	23,5	8,0	3,1	50
P12	0,01	0.3	0,1	22,0	bal.	8,5	

\* According to WRC-92.

Wire electrodes used	Yield strength 0,2%	Tensile strength	Elongation (L <sub>0</sub> =5d <sub>0</sub> )	Impact values in J CVN		
	≥ MPa	≥ MPa	≥ %	+20°C	-40°C	-196°C
316L/SKR	415	560	36	80	40	35
2205	600	800	27	100	70	

<b>Classifications</b>	high-alloyed	
EN ISO 14174:		
SA FB 2 DC		

**Characteristics and field of use**

Agglomerated, fluoride-basic welding flux for joint welding to Cr steels and to unstabilised or stabilised austenitic CrNi(Mo) steels and to austenitic-ferritic duplex steels. The BÖHLER BB 202 flux yields a well-flowed, smooth seam, a very thin slag and therefore a low flux consumption. The flux also features good slag detachability and good fillet welding properties.

**Base materials**

Cr steels and unstabilised or stabilised austenitic CrNi(Mo) steels, as well as austenitic-ferritic duplex steels

**Composition of Sub-arc Welding Flux**

SiO <sub>2</sub>	Al <sub>2</sub> O <sub>3</sub>	CaF <sub>2</sub>	
10	38	50	

**Operating data**

	Polarity = ±	basicity acc. Boniczewski:	2,3 Mol. %
		bulk density:	1,0 kg/dm <sup>3</sup>
		grain size acc. EN ISO 14174:	4-14 (0.4-1.4 mm)
		flux consumption:	0.7 kg flux per kg wire
		re-drying:	300-350 C, 2 h

**Typical analysis for wire and weld metal in wt. %:**

Designation SAW Wires	C	Si	Mn	Cr	Mo	Ni	EN ISO (wire) A5.17 – AWS A5.23
BÖHLER EAS 4 M-U	0,02	0,6	1,2	18,0	2,8	12,2	S 19 12 3 L ER316L

**Approvals and certificates**

BÖHLER BB 202 together with BÖHLER EAS 4 M-UP: TÜV-D

<b>Classifications</b>	high-alloyed	
EN ISO 14174:		
SA FB 2 64 DC		

### Characteristics and field of use

Marathon 431 is an agglomerated basic welding flux for welding stainless high alloyed CrNi(Mo) steels. The weld seams are smooth and finely rippled without any slag residues. Besides the good slag detachability the flux also provides good fillet weld properties. The weld metals show high degree of purity and good mechanical properties.

### Composition of Sub-arc Welding Flux

SiO <sub>2</sub>	Al <sub>2</sub> O <sub>3</sub>	CaF <sub>2</sub>	
10	38	50	

### Operating data

	Polarity = ±	basicity acc. Boniczewski:	2,3 Mol.%
		grain size acc. EN ISO 14174:	4 - 14 (0.4 - 1.4 mm)
		re-drying:	300-350 C, 2 h

### Typical analysis for wire and weld metal in wt. %:

Designation	C	Si	Mn	Cr	Mo	Ni	Nb	N
Thermanit A Weld metal	0,040 0,038	0,50 0,60	1,7 1,2	19,5 19,0	2,8 2,8	11,5 11,5	0,65 0,50	
Thermanit GE-316L Weld metal	0,012 0,012	0,50 0,60	1,7 1,2	18,5 18,0	2,8 2,8	12,2 12,2		
Thermanit H-347 Weld metal	0,040 0,038	0,50 0,60	1,8 1,3	19,5 19,0		9,5 9,5	0,65 0,50	
Thermanit JE-308L Weld metal	0,016 0,015	0,50 0,60	1,8 1,3	20,0 19,5		9,8 9,8		
Thermanit 22/09 Weld metal	0,015 0,013	0,40 0,50	1,6 1,1	23,0 22,5	3,2 3,2	8,8 8,8		0,15 0,15
Thermanit 25/14 E-309L Weld metal	0,014 0,013	0,50 0,60	1,8 1,3	24,0 23,8		13,2 13,2		

## Marathon 431

Mechanical properties of the weld metal, as welded:

Designation	Yield strength 0,2%	Tensile strength	Elongation ( $L_0=5d_0$ )	KImpact values in J CVN at RT
	≥ MPa	≥ MPa	≥ %	≥ J
Thermanit A	380	550	30	70
Thermanit GE-316L	350	550	30	70
Thermanit H-347	380	550	30	65
Thermanit JE-308L	320	550	35	65
Thermanit 22/09	480	690	25	80
Thermanit 25/14 E-309L	380	600	30	100

Examples of application

Material specification	Material No.	Designation
X2CrNiMoN22-5	1.4462	Thermanit 22/09
X6CrNiMoTi17-12-2	1.4571	Thermanit A
X2CrNiMo17-13-2	1.4404	Thermanit GE-316L
X6CrNiNb18-9	1.4550	Thermanit H-347
X2CrNi19-11	1.4306	Thermanit JE-308L

Approvals	TÜV	ABS	DNV	GL	LR
Thermanit A	06985				
Thermanit GE-316L	06113				
Thermanit H-347	06479				
Thermanit JE-308L	06114				
Thermanit 22/09	06112	X	X	X	X



**Classifications**

high-alloyed

EN ISO 14174:

SA FB 2 DC H5

**Characteristics and field of use**

Agglomerated fluoride-basic special welding flux for welding highly creep resistant 9% Cr steels of types P91/T91, P911 and NF616 (type P92/T92). The weld seam features a smooth, finely rippled surface without undercuts. The flux is one of the hydrogen controlled fluxes; the diffusible hydrogen content is max. 5 ml/100 g of weld metal.

**Base materials**

Highly creep resistant 9% Cr steels of types P91/T91, X10CrMoVNb9-1 (1.4903), types P92/T92, NF616 and X11CrMoWVNb9-1-1 (1.4905)

**Composition of Sub-arc Welding Flux**

SiO <sub>2</sub> +Al <sub>2</sub> O <sub>3</sub>	CaF <sub>2</sub> +CaO+MgO
35	60

**Operating data**



Polarity = +-

basicity acc. Boniczewski: 2,9 Mol.%  
 bulk density: 1,0 kg/dm<sup>3</sup>  
 grain size acc. EN ISO 14174: 3-20 (0.3-2.0 mm)  
 flux consumption: 1,0 kg flux per kg wire  
 re-drying: 300-350 C, 2 h

**Typical analysis for wire and weld metal in wt. %:**

Designation SAW Wires	C	Si	Mn	Cr	Mo	Ni	V	Nb	N
BÖHLER C 9 MV-UP	0,1	0,22	0,6	8,7	0,93	0,45	0,18	0,05	0,04

Designation	wire classification	classification for wire flux/combination	
	EN ISO 24598	acc. EN ISO	acc. AWS A5.23
BÖHLER C 9 MV-UP	S S CrMo91	S S CrMo91 FB	F9PZ-EB9-B9 / F62PZ-EB9-B9

**Approvals and certificates**

BÖHLER BB 910 together with BÖHLER EAS 4 M-UP: TÜV-D

# Marathon 543

SAW Flux

<b>Classifications</b>	high-alloyed	
EN ISO 14174:		
SA FB 2 55 DC H5		

## Characteristics and field of use

Marathon 543 is an agglomerated flux of fluoride basic type with a high basicity. Outstanding good welding properties. For joining and surfacing applications of creep resistant CrMo steels such as e.g. 12CrMo19-5 (Mat. No. 1.7362), P 91/T 91, X10CrMoVNb9-1 (Mat. No. 1.4903), P92/T92, X20CrMoWV12-1 (Mat. No. 1.4935). In combination with the new sub arc wires Thermanit MTS 616 the flux is suited for welding steels of type P 92 according to ASTM A 335.

## Composition of Sub-arc Welding Flux

SiO <sub>2</sub> + Al <sub>2</sub> O <sub>3</sub>	CaF <sub>2</sub> + CaO + MgO	
35	60	

## Operating data

	Polarity = - / -	basicity acc. Boniczewski: grain size acc. EN ISO 14174: 3 – 20 (0.3 – 2.0 mm) re-drying: 300-350 C, 2 h
---	------------------	--

## Approvals

	TÜV
Thermanit MTS 3	06527
Thermanit MTS 616	09391

## Typical analysis for wire and weld metal in wt. %:

Marke	C	Si	Mn	Cr	Mo	Ni	V	Nb	N	W
Thermanit MTS 3 Weld metal	0,11 0,09	0,25 0,22	0,50 0,70	9,00 8,90	0,95 0,93	0,40 0,40	0,22 0,18	0,06 0,05	0,05 0,04	
Thermanit MTS 616 Weld metal	0,11 0,09	0,25 0,22	0,50 0,70	8,90 8,80	0,45 0,43	0,40 0,40	0,22 0,18	0,06 0,05	0,05 0,04	1,70 1,70

## Mechanical properties of the weld metal, as welded:

Designation	Heat Treatment	Test temp.	Yield strength 0,2%	Tensile strength	Elongation (L <sub>0</sub> =5d <sub>0</sub> )	Impact values in J CVN
		°C	≥ MPa	≥ MPa	≥ %	≥ J
Thermanit MTS 3	750 C / 4 h	+20 C	540	700	18	47
		400	400	540	14	
		460	380	500	14	
		500	360	360	14	
Thermanit MTS 616	760 C / 4 h	+20 C	560	700	18	41
		600	290	350	16	

\*Special heat treatment

<b>Classifications</b>	high-alloyed	
EN ISO 14174:		
SA CS 2 Cr DC		

#### Characteristics and field of use

Avesta Flux 801 is a neutral chromiumcompensated agglomerated flux. It is a generalpurpose flux designed for both joint welding stainless steel and for cladding onto unalloyed or low-alloyed steel. Flux 801 can be used in combination with all types of stabilised and non-stabilised Cr-Ni and Cr-Ni-Mo fillers. It provides neat weld surfaces, very good welding properties and easy slag removal. Flux 801 is chromium-alloyed to compensate for losses in the arc during welding.

- Bulk density: 0.8 kg/dm<sup>3</sup>
- Basicity index: 1.0 (Boniszewski)
- Consumption: 0.4 kg flux/kg wire (26 V) 0.7 kg flux/kg wire (34 V)

#### Flux care

The flux should be stored indoors in a dry place. Moist flux can be redried at 250 – 300°C for 2 hours. Both heating and cooling must be carried out slowly.

#### Basic materials

For welding with submerged arc wire such as Avesta Welding 308L/MVR, 316L/SKR, 309L and P5

#### Typical analysis for wire and weld metal in wt. %:

Designation	C	Si	Mn	Cr	Ni	Mo	FN*
308L/MVR	0,02	0,9	1,0	20,0	9,5		11
316L/SKR	0,02	0,9	1,0	19,0	12,0	2,6	10

\* According to WRC-92.

Wire electrodes used	Yield strength	Tensile strength	Elongation	Impact values		
	0,2%		( $L_0=5d_0$ )	in $\geq J$ CVN		
	$\geq MPa$	$\geq MPa$	$\geq \%$	+20 °C	-40 °C	-60 °C
308L/MVR	410	590	37	65	40	35
316L/SKR	430	580	36	70	60	30

## Chapter 5.1 - Flux cored wire (unalloyed, low-alloyed)

Product name	EN ISO	AWS	Page
BOHLER Ti 52-FD	T 46 4 P M 1 H10 / T 42 2 P C 1 H5	E71T1-M21A4-CS1-H8; E71T1-C1A2-CS1-H4	2
Union TG 55 M	T 46 4 P M 1 H10 / T 42 2 P C 1 H5	E71T-1MJH8 / E71T-1CH8	3
BOHLER PIPESHIELD 71 T8-FD	-	E71T8-A4-K6	4
BOHLER PIPESHIELD 81 T8-FD	-	E81T8-A4-G ; E81T8-A4-Ni2	5
BOHLER Ti 60-FD	T 50 6 1Ni P M 1 H5	E81T1-M21A8-Ni1-H4	6
BOHLER Ti 70 PIPE-FD	T 55 4 Mn1Ni P M 1H5	E91T1-M21A4-G	7
BOHLER DMO Ti-FD	T MoL P M 1 H10	E81T1-M21P -A1H8	8
BOHLER DCMS Ti-FD	T CrMo1 P M 1 H10	E81T1-M21P -B2H8	9

## Classifications

unalloyed rutile

EN ISO 17632-A:

AWS A5.36:

T 46 4 P M 1 H10; T 42 2 P C 1 H5

E71T1-M21A4-CS1-H8; E71T1-C1A2-CS1-H4

## Characteristics and field of use

Rutile flux cored wire with fast freezing slag. Outstanding welding properties in all positions. Excellent mechanical properties and good slag detachability, low spatter losses, smooth, finely rippled seam surface, high X-ray security, notch-free weld toes. Out-of-position welding can be carried out with increased welding current, and therefore very economically with increased deposition rate.

## Base materials

Steels up to a yield strength of 460 MPa (67 ksi) (shielding gas M21)  
 S235JR-S355JR, S235JO-S355JO, S450JO, S235J2-S355J2, S275N-S460N,  
 S275M-S460M, P235GH-P355GH, P275NL1-P460NL1, P215NL, P265NL, P355N,  
 P285NH-P460NH, P195TR1-P265TR1, P195TR2-P265TR2, P195GH-P265GH, L245NBL415NB,  
 L450QB, L245MB-L450MB, GE200-GE240, shipbuilding steels: A, B, D, E, A 32-E 36  
 ASTM A 106 Gr. A, B, C; A 181 Gr. 60, 70; A 283 Gr. A, C; A 285 Gr. A, B, C; A 350 Gr. LF1; A  
 414 Gr. A, B, C, D, E, F, G; A 501 Gr. B; A 513 Gr. 1018; A 516 Gr. 55, 60, 65, 70;  
 A 573 Gr. 58, 65, 70; A 588 Gr. A, B; A 633 Gr. C, E; A 662 Gr. B; A 711 Gr. 1013;  
 A 841 Gr. A; API 5 L Gr. B, X42, X52, X56, X60, X65

## Typical analysis of all-weld metal (Wt-%)

C	Si	Mn	Ti	
0,06	0,5	1,2	0,05	

## Mechanical properties of all-weld metal

Heat Treatment	Yield strength 0,2%	Tensile strength	Elongation ( $L_0=5d_0$ )	Impact values in J CVN		
	MPa	MPa	%	+20°C:	-20°C:	-40°C:
untreated	500	580	26	180	130	90

## Operating data

	Polarity = +	re-drying: if necessary: 150°C/24 h shielding gases: Argon + 15-25% CO2 100% CO2 Welding with conventional MAG devices.
---	--------------	--

## Dimensions (mm)

1,2	1,6			
-----	-----	--	--	--

## Approvals and certificates

TÜV-D (11164.), DB (42.014.35), ABS, GL, LR, DNV, BV, CRS, CE

# Union TG 55 M

Flux cored wire

## Classifications

unalloyed rutile

EN ISO 17632-A:

AWS A5.20:

T 46 4 P M 1 H10; T 42 2 P C 1 H5

E71T-1MJH8 /; E71T-1CH8

## Characteristics and field of use

Union TG 55 M is an all position flux cored wire that displays exceptional high impact properties in the as welded as well as in the stress relieved condition with mixed gas M21 acc. to EN ISO 14175. This "welder friendly" wire with its soft, spatterfree arc always operates in the spray arc mode. It is possible to weld in all positions with one diameter (1.2 mm from 160 A to 250 A), so ideal for fit-up work. Deposition rates in vertical-up welding can reach 2.2 - 5.5 kg/h, making it one of the most productive consumables available. Because of spray arc operation, typical positional welding defects like lack of fusion and slag inclusions are avoided. The wire has a high tolerance for poor weld preparations. The slag is easily to detach. Good bead appearance with smooth tie-in. Single sided root runs are made economically on ceramic backing. Commercial application include construction, shipbuilding railcar and heavy equipment industries.

## Base materials

S185, S235J2G3, S275JR, S355J2G3 (St 33, St 37-3N, St44-2, QSt 52-3N), E295 (St 50-2, P235GH, P265GH, P295GH, P355GH (H1, H11, 17 Mn 4, 19 Mn 6), P275N, P355N, P355NL2, P460N (StE 285, EstE 285, EstE 355, StE 460), S275N, S275NL, S355N, S355NL, S460N (StE 285, TStE 285, StE 355, TStE 355, StE 460), L210, L240, L290, L360 (StE 210.7, StE 240.7, StE 290.7, StE 360.7), L290NB, L360MB, L415MB (StE 290.7 TM, StE 360.7 TM, StE 415.7 TM), X42 / StE 290.7 TM – X65 / StE 445.7 TM (API-5LX), GS-38 – GS-52,

## Typical analysis of all-weld metal (Wt-%)

C	Si	Mn	P	S
0,05	0,45	1,35	≤ 0.015	≤ 0.015

## Mechanical properties of all-weld metal

Heat Treatment	Shielding Gas	Yield strength 0,2%	Tensile strength	Elongation ( $L_0=5d_0$ )	Impact values in J CVN	
					at room temperature	-40°C:
AW	M21	460	560	24	140	80
580°C/2h	M21	420	500	26	140	50
AW	C1	420	520	24	140	70

## Operating data

	Polarity = +	Shielding gas (EN ISO 14175) M1- M3 and C1
---	--------------	--

Dimensions (mm)	Amperage A
1,2	150-350

## Approvals and certificates

TÜV (Certificate No. 1831), DB (Reg. Approvals form No. 42.132.14)

**Classifications**

low-alloy pipeline

AWS A5.36:

E71T8-A4-K6

**Characteristics and field of use**

Self-shielding flux cored wire is specially developed for pipeline welding in the vertical down position (5G). Can also be used for welding unalloyed steel constructions. BÖHLER Pipeshield 71 T8-FD offers a fast freezing, easily removable slag, good welding properties, easy handling for the welder and high productivity. The wire has good mechanical properties and high impact energy values at low temperatures. Advantages in vertical down welding for hot pass, filler pass and cover pass welding. Thanks to the fluoride-basic core, the interpass temperature is similar to that of basic electrodes; we recommend 80-200°C. BÖHLER self-shielding flux cored wire offers easy handling for the welder as a result of the tolerant stick out. It also offers a low tendency to porosity, even when welded with relatively long arcs.

**Base materials**

According to API 5L: A, B, X42, X46, X52, X56, X60, (X65, X70)

**Typical analysis of all-weld metal (Wt-%)**

C	Si	Mn	Al	Ni
0,045	0,14	1,1	0,8	0,7

**Mechanical properties of all-weld metal**

Heat Treatment	Yield strength 0,2%	Tensile strength	Elongation ( $L_0=5d_0$ )	Impact values in J CVN		
				+20°C:	-30°C:	-40°C:
untreated	MPa 435	MPa 535	% 28	200	150	100

**Operating data**

	Polarity = -	no shielding gas recommended stick out: 10-25 mm
--	--------------	---

**Dimensions (mm)**

2,0

**Approvals and certificates**

NAKS, GAZPROM

## Classifications

low-alloy pipeline

AWS A5.36:

E81T8-A4-G ; E81T8-A4-Ni2

## Characteristics and field of use

BÖHLER Pipeshield 81 T8-FD is a self-shielding flux cored wire, and is specially developed for semiautomatic pipeline welding in the vertical down position (5G). Can also be used for welding low-alloy steel constructions. This wire offers a fast freezing, easily removable slag, and good welding properties in all positions. BÖHLER Pipeshield 81 T8-FD offers good mechanical properties and consistently high impact energy values at low temperatures. It offers advantages in vertical down welding for hot pass, filler pass and cover pass welding. Thanks to the fluoride-basic core, the interpass temperature is similar to that of basic electrodes; we recommend 80-200°C. BÖHLER self-shielding flux cored wire offers easy handling for the welder as a result of the tolerant stick out. It also offers a low tendency to porosity, even when welded with relatively long arcs.

## Base materials

According to API 5L: X65, X70

## Typical analysis of all-weld metal (Wt-%)

C	Si	Mn	Al	Ni
0,05	0,15	1,4	0,8	1,95

## Mechanical properties of all-weld metal

Heat Treatment	Yield strength 0,2%	Tensile strength	Elongation ( $L_0=5d_0$ )	Impact values in J CVN		
				+20°C:	-30°C:	-40°C:
untreated	500	600	25	170	120	90

## Operating data



Polarity = -

no shielding gas  
recommended stick out: 10-25 mm

## Dimensions (mm)

2,0

## Approvals and certificates

NAKS, GAZPROM



## Classifications

low-alloy rutile high strength

EN ISO 17632-A:

AWS A5.36:

T 50 6 1Ni P M 1 H5

E81T1-M21A8-Ni1-H4

## Characteristics and field of use

Rutile flux cored wire with fast freezing slag for welding low-temperature steels. Outstanding welding properties in all positions. Exceptional mechanical strength and good slag detachability, low spatter losses, smooth, finely rippled seam surface, notch-free weld toes. Out-of-position welding can be carried out with increased welding current, and therefore very economically with increased deposition rate. For high-quality welding in shipbuilding, for offshore applications and steel structures with high strength requirements, as well as for low-temperature applications down to -60°C.

## Base materials

general structural steels, pipe and boiler steels, cryogenic fine-grained structural steels and special qualities. S355JR, S355JO, S355J2, S450JO, S355N-S460N, S355NL-S460NL, S355M-S460M, S355ML-S460ML, S460Q, S500Q, S460QL, S500QL, S460QL1, S500QL1, P355GH, P355NH, P420NH, P460NH, P355N-P460N, P355NH-P460NH, P355NL1-P460NL1, P355NL2-P460NL2, L245NB-L415NB, L245MB-L485MB, L360QB-L485QB, aldur 500Q, aldur 500QL, aldur 500QL1 ASTM A 350 Gr. LF2; A 516 Gr. 65, 70; A 572 Gr. 42, 50, 60, 65; A 573 Gr. 70; A 588 Gr. B, C, K; A 633 Gr. A, C, D, E; A 662 Gr. B, C; A 678 Gr. B; A 707 Gr. L2, L3; A 841 Gr. A, B, C; API 5 L X42, X52, X60, X65, X70, X52Q, X60Q, X65Q, X70Q

## Typical analysis of all-weld metal (Wt-%)

C	Si	Mn	Ni	
0,06	0,45	1,3	0,9	

## Mechanical properties of all-weld metal

Heat Treatment	Yield strength 0,2%	Tensile strength	Elongation ( $L_0=5d_0$ )	Impact values in J CVN			
				+20°C:	-20°C:	-40°C:	-60°C:
untreated	MPa 530	MPa 570	% 27	140	120	100	60

## Operating data

	Polarity = +	re-drying: - if necessary: 150°C / 24 h shielding gas: Argon + 15-25% CO2 Welding with conventional MAG devices. Preheating and interpass temperature as required by the base metal.
---	--------------	--

## Dimensions (mm)

1,2

## Approvals and certificates

TÜV (applied for), DB (applied for), GL (applied for), DNV (applied for), ABS (applied for), LR (applied for), BV (applied for)

<b>Classifications</b>	low-alloy rutile high strength
EN ISO 18276-A:	AWS A5.36:
T 55 4 Mn1Ni P M 1 H5	E91T1-M21A4-G

#### Characteristics and field of use

Micro-alloyed rutile flux cored wire for single and multi-pass welding of carbon-manganese steels and high-strength steels using Ar-CO<sub>2</sub> shielding gas. Outstanding welding properties in all positions, exceptional bead appearance, no spatter, fast freezing, easily removable slag. The unusual mechanical properties of this wire even at low temperatures (-40°C), along with its low hydrogen content, make it particularly useful for laying pipelines. Other applications are found in the offshore industry, in shipbuilding, and for constructions using high-strength steels.

#### Base materials

Pipe steels and fine-grained structural steels S460-S500N, S460NL-S500NL, S500NC-S550NC, L450MB-L485MB (L555MB) API spec. 5L: X65, X70, (X80)

#### Typical analysis of all-weld metal (Wt-%)

C	Si	Mn	Ni	
0,07	0,5	1,5	0,95	

#### Mechanical properties of all-weld metal

Heat Treatment	Yield strength 0,2%	Tensile strength	Elongation (L <sub>0</sub> =5d <sub>0</sub> )	Impact values in J CVN
	MPa	MPa	%	-40°C:
untreated	≥ 550	640-820	≥ 18	≥ 47

#### Operating data

	Polarity = +	re-drying if necessary: 150°C/24 h shielding gases: Ar + 15-25% CO <sub>2</sub> 14-20 l/min Welding with conventional MAG devices. The product is available on 5 kg and 16 kg spools. Preheating and interpass temperature as required by the base metal.
--	--------------	--

#### Dimensions (mm)

1,2

#### Approvals and certificates

TÜV-D (12279), CE, GAZPROM

**BÖHLER DMO Ti-FD**

Flux cored wire

**Classifications**

low-alloy rutile creep resistant

EN ISO 17634-A:

AWS A5.36:

T MoL P M 1 H10

E81T1-M21P -A1H8

**Characteristics and field of use**

BÖHLER DMO Ti-FD is a flux cored wire for welding in boiler, pressure vessel, pipeline and steel construction, preferably for creep resistant steel qualities with 0.5% Mo. The fast-hardening slag makes this flux cored wire particularly suitable for out-of-position welding, where significant savings in time and cost can be achieved through the use of a higher welding current. It is characterised by easy welding and spray arc welding in all welding positions. Good slag detachability, low spatter losses, smooth, clean-flowing seam profiles in X-ray quality are further characteristics of this flux cored wire.

**Base materials**

similar alloy creep resistant steels and cast steel 16Mo3, S235JR-S355JR, P195TR1-P265TR1, L245NB-L415NB, L450QB, L245MB-L450MB, GE200-GE300 ASTM A 29 Gr. 1016; A 106 Gr. A, B; A 182 Gr. F1; A 234 Gr. WP1; A 283 Gr., C, D; A 335 Gr. P1; A 501 Gr. B; A 510 Gr. 1013; A 512 Gr. 1021, 1026; A 513 Gr. 1021, 1026; A 711 Gr. 1013; API 5 L B, X42, X52, X60, X65

**Typical analysis of all-weld metal (Wt-%)**

C	Si	Mn	Mo
0,04	0,25	0,75	0,5

**Mechanical properties of all-weld metal**

Heat Treatment	Yield strength 0,2%	Tensile strength	Elongation ( $L_0=5d_0$ )	Impact values in J CVN
	MPa	MPa	%	+20°C:
untreated	540	600	23	120
annealed*	510	570	23	140

\*620°C/1 h/furnace down to 300°C/air – shielding gas Ar + 18% CO<sub>2</sub>

**Operating data**

	Polarity = +	re-drying: – in exceptional cases: 150°C/24 h shielding gases: Argon + 15-25% CO <sub>2</sub> Adapt the preheating and interpass temperatures and the subsequent heat treatment to the base material. Preheating to ≥ 150°C is recommended for thick components. Stress-relief at between 600°C and 630°C for a minimum duration of one hour.
--	--------------	--

**Dimensions (mm)**

1,2

**Amperage A**

150-330

**Approvals and certificates**

TÜV-D (11120.), CE

**Similar alloy filler metals**

GTAW rod:	DMO-IG EMS 2 Mo/BB 400	SAW combination	EMS 2 Mo/BB 24 FOX DMO Ti EMS 2 Mo/BB 306
SMAW electrode:	FOX DMO Kb	GMAW solid wire:	DMO-IG EMS 2 Mo/BB 418 TT
Gas welding rod:	DMO EMS 2 Mo/BB 421 TT		

# BÖHLER DCMS Ti-FD

Flux cored wire

<b>Classifications</b>	low-alloy rutile creep resistant
EN ISO 17634-A:	AWS A5.36:
T CrMo1 P M 1 H10	E81T1-M21P -B2H8

## Characteristics and field of use

The BÖHLER DCMS Ti-FD welding consumable is a low-alloy, slagging flux cored wire with rutile core for welding in boiler, pressure vessel and pipeline construction, preferably for the creep resistant steel qualities alloyed with 1% chromium and 0.5% molybdenum. The fast-hardening slag makes this flux cored wire particularly suitable for out-of-position welding, where significant savings in time and cost can be achieved through the use of a higher welding current.

## Base materials

same alloy creep resistant steels and cast steel, case-hardening and nitriding steels with comparable composition, heat treatable steels with comparable composition with tensile strengths up to 780 MPa, steels resistant to caustic cracking 1.7335 13CrMo4-5, 1.7262 15CrMo5, 1.7728 16CrMoV4, 1.7218 25CrMo4, 1.7225 42CrMo4, 1.7258 24CrMo5, 1.7354 G22CrMo5-4, 1.7357 G17CrMo5-5 ASTM A 182 Gr. F12; A 193 Gr. B7; A 213 Gr. T12; A 217 Gr. WC6; A 234 Gr. WP11; A335 Gr. P11, P12; A 336 Gr. F11, F12; A 426 Gr. CP12

## Typical analysis of all-weld metal (Wt-%)

C	Si	Mn	Cr	Mo	P	As	Sn	Sb
0,06	0,22	0,75	1,2	0,47	0,015	0,005	0,005	0,005

## Mechanical properties of all-weld metal

Heat Treatment	Yield strength	Tensile strength	Elongation	Impact values
	0,2%		( $L_0=5d_0$ )	in J CVN
	MPa	MPa	%	+20°C:
annealed*	≥ 460	555-740	≥ 20	≥ 47

\*690°C/1 h – shielding gas Ar + 18% CO<sub>2</sub>

## Operating data

	Polarity = +	re-drying: – in exceptional cases: shielding gases: Argon + 15-25% CO <sub>2</sub> Adapt the preheating and interpass temperatures and the subsequent heat treatment to the base material.
--	--------------	--

Dimensions (mm)	Amperage A
1,2	150-330

## Approvals and certificates

TÜV-D (11162.), CE

## Similar alloy filler metals

SMAW electrode:	FOX DCMS Kb	SAW combination	EMS 2 CrMo/BB 24
GTAW rod:	DCMS-IG EMS 2 CrMo/BB 24 SC	GMAW solid wire:	DCMS-IG EMS 2 CrMo/BB 418 TT
Gas welding rod:	DCMS FOX DCMS Ti		



## Chapter 5.2 - Flux cored wire (high-alloyed)

Product name	EN ISO	AWS	Page
Avesta FCW-2D 308L/MVR	T 19 9 L R M/C 3	E308LT0-4 ; E308LT0-1	2
Avesta FCW 308L/MVR-PW	T 19 9 L P M/C 1	E308LT1-4 ; E308LT1-1	3
BOHLER EAS 2-FD	T 19 9 L R M(C) 3	E308LT0-4 ; E308LT0-1	4
BÖHLER EAS 2 PW-FD	T 19 9 L P M(C) 1	E308LT1-4 ; E308LT1-1	5
Thermanit TG 308 L	T 19 9 L R M/C3	E308LT0-4 ; E308LT0-1	6
Avesta FCW-2D 309L	T 23 12 L R M/C 3	E309LT0-4 ; E309LT0-1	7
Avesta FCW 309L-PW	T 23 12 L P M/C1	E309LT1-4 ; E309LT1-1	8
BOHLER CN 23/12-FD	T 23 12 L R M(C) 3	E309LT0-1 ; E309LT0-4	9
BOHLER CN 23/12 PW-FD	T 23 12 L P M/C1	E309LT1-4 ; E309LT1-1	10
Thermanit TG 309 L	T 23 12 L R M(C) 3	E309LT0-4 ; E309LT0-1	11
Avesta FCW-2D 316L/SKR	T 19 12 3 L R M/C3	E316LT0-4 ; E316LT0-1	12
Avesta FCW 316L/SKR-PW	T 19 12 3 L P M/C1	E316LT1-4 ; E316LT1-1	13
BOHLER EAS 4 M-FD	T 19 12 3 L R M(C) 3	E316LT0-4 ; E316LT0-1	14
BOHLER EAS 4 PW-FD	T 19 12 3 L P M/C1	E316LT1-4 ; E316LT1-1	15
BOHLER EAS 4 PW-FD (LF)	T 219 12 3 L P M/C1	E316LT1-4 ; E316LT1-1	16
Thermanit TG 316 L	T 19 12 3 L R M(C) 3	E316LT0-4 ; E316LT0-1	17
Avesta FCW-2D 347/MVNB	T 19 9 Nb R M/C3	E347T0-4 ; E347T0-1	18
BOHLER SAS 2-FD	T 19 9 Nb R M(C) 3	E347T0-4 ; E347T0-1	19
BOHLER SAS 2 PW-FD	T 19 9 Nb P M(C) 1	E347T1-4 ; E347T1-1	20
Avesta FCW-2D 2205	T 22 9 3 NL R M/C3	E2209T0-4 ; E2209T0-1	21
Avesta FCW 2205-PW	T 22 9 3 N L P M(C) 1	E2209T1-4 ; E2209T1-1	22
BOHLER CN 22/9 PW-FD	T 22 9 3 NL P M(C) 1	E2209T1-4 ; E2209T1-1	23
Avesta FCW-2D LDX 2101	T Z 24 9 N L R M(C) 3	E2307T0-4 ; E2307T0-1	24
Avesta FCW LDX 2101-PW	T Z 24 9 N L P M(C) 1	E2307T1-4 ; E2307T1-1	25
Avesta FCW 2507/P100-PW	T 25 9 4 N L P M21 (C1) 2	E2594T1-4 ; E2594T1-1	26
BOHLER A7 FD	T 18 8 Mn R M(C) 3	E307T0-G	27
BOHLER A 7-MC	T 18 8 Mn M M 1	EC307 (mod.)	28
Avesta FCW-2D P5	T 23 12 2 L R M/C3	E309LMoT0-4 ; E309LMoT0-1	29
BOHLER CN 23/12 Mo-FD	T 23 12 2 L R M(C) 3	E309LMoT0-4 ; E309LMoT0-1	30
BOHLER CN 23/12 Mo PW-FD	T 23 12 2 L P M(C) 1	E309LMoT1-4 ; E309LMoT1-1	31
BOHLER CN 13/4-MC	T 13 4 M M 2	EC410NiMo (mod.)	32
Avesta FCW P12-PW	T Ni 6625 P M 2	ENiCrMo3T1-4	33
BOHLER NiBAS 625 PW-FD	T Ni 6625 P M 2	ENiCrMo3T1-4	34
UTP AF 6222 MoPW	T Ni 6625 P M 2	ENiCrMo3T1-4	35
BÖHLER NiBAS 70/20-FD	T Ni 6082 R M 3	ENiCr3T0-4	36
UTP AF 068 HH	T Ni 6082 R M 3	ENiCr3T0-4	37

A FC - 0 L MVR

Flux cored wire

**Classifications**

high-alloyed rutile

EN ISO 17633-A:

AWS A5.22:

T 19 9 L R M/C 3

E308LT0-4 ; E308LT0-1

**Characteristics and field of use**

Avesta FCW-2D 308L/MVR is designed for welding 1.4301/ASTM 304 type stainless steels. It is also suitable for welding steels that are stabilised with titanium or niobium, such as 1.4541/ASTM 321, 1.4878/321H and 1.4550/347 in cases where the construction will be operating at temperatures below 400 °C. For higher temperatures a niobium stabilised consumable such as Avesta FCW-2D 347/MVNB is required. Avesta FCW-2D 308L/MVR provides excellent weldability in flat as well as horizontal/vertical position. Welding in vertical-up and overhead positions is preferably done using FCW 308L/MVR-PW. FCW-2D 308L/MVR diam. 0.9 mm can be welded in all positions. Avesta FCW-2D 308L/MVR should be welded using direct current positive polarity (DC+) with a recommended wire stick-out of 15 – 20 mm. Corrosion resistance: Very good under fairly severe conditions, e.g. in oxidising acids and cold or dilute reducing acids.

**Base materials**

For welding steels such as

Outokumpu	EN	ASTM	BS	NF	SS
4301	1.4301	304	304S31	Z7 CN 18-09	2333
4307	1.4307	304L	304S11	Z3 CN 18-10	2352
4311	1.4311	304LN	304S61	Z3 CN 18-10 Az	2371
4541	1.4541	321	321S31	Z6 CNT 18-10	2337

**Typical composition of all-weld metal (Wt-%)**

C	Si	Mn	Cr	Ni
0,025	0,8	1,5	19,3	10,9

Ferrite 7 FN; WRC-92

**Mechanical properties of all-weld metal**

Heat Treatment	Yield strength 0,2%	Tensile strength	Elongation ( $L_0=5d_0$ )	Impact values in J CVN		
				+20°C:	-40°C:	-196°C:
untreated	380	560	35	60	50	35

**Operating data**

Polarity = +

shielding gas: Ar + 15 – 25% CO<sub>2</sub>  
offers the best weldability, but 100% CO<sub>2</sub> can also be used (voltage should be increased by 2V).  
Gas flow rate 20 – 25 l/min.

**Dimensions (mm)****Amperage**

0,9

100-160

1,2

125-280

1,6

200-350

**A FC 0 L MVR-P** Flux cored wire

<b>Classifications</b>	high-alloyed rutile	
EN ISO 17633-A:	AWS A5.22:	
T 19 9 L P M/C 1	E308LT1-4 ; E308LT1-1	

**Characteristics and field of use**

Avesta FCW 308L/MVR-PW is designed for welding 1.4301/ASTM 304 type stainless steels. It is also suitable for welding steels that are stabilised with titanium or niobium, such as 1.4541/ASTM 321, 1.4878/321H and 1.4550/347 in cases where the construction will be operating at temperatures below 400 °C. For higher temperatures a niobium stabilised consumable such as Avesta FCW-2D 347/MVNb is required. Avesta FCW 308L/MVR-PW has a stronger arc and a faster freezing slag compared to the 2D type. It is designed for all-round welding and can be used in all positions without changing the parameter settings. Weldability is excellent in the vertical-up and overhead welding positions. Avesta FCW 308L/MVR-PW should be welded using direct current positive polarity (DC+) with a recommended wire stick-out of 15 – 20 mm.

**Corrosion resistance:**

Corresponding to 1.4301/ASTM 304, i.e. very good under fairly severe conditions, e.g. in oxidising acids and cold or dilute reducing acids.

**Base materials**

For welding steels such as					
Outokumpu	EN	ASTM	BS	NF	SS
4301	1.4301	304	304S31	Z7 CN 18-09	2333
4307	1.4307	304L	304S11	Z3 CN 18-10	2352
4311	1.4311	304LN	304S61	Z3 CN 18-10 Az	2371
4541	1.4541	321	321S31	Z6 CNT 18-10	2337

**Typical analysis of all-weld metal (Wt-%)**

C	Si	Mn	Cr	Ni
0, 025	0,7	1,4	19,7	10,2

**Ferrite 9 FN;WRC-92**

**Mechanical properties of all-weld metal**

Heat Treatment	Yield strength 0,2%	Tensile strength	Elongation (L <sub>0</sub> =5d <sub>0</sub> )	Impact values in J CVN
	MPa	MPa	%	+20°C:
untreated	390	570	39	60

**Operating data**

	Polarity = +	shielding gas: Ar + 15 – 25% CO <sub>2</sub> offers the best weldability, but 100% CO <sub>2</sub> can also be used (voltage should be increased by 2V). Gas flow rate 20 – 25 l/min.
---	--------------	---

Dimensions (mm)	Amperage
1,2	150-240



## Classifications

high-alloyed rutile

EN ISO 17633-A:

AWS A5.22

T 19 9 L R M/C 3

E308LT0-4 ; E308LT0-1

## Characteristics and field of use

Rutile, strip alloyed, flux cored wire for MAG welding of austenitic CrNi steels, primarily in flat and horizontal welding positions. The easy handling and high deposition rate of BÖHLER EAS 2-FD result in high productivity with excellent welding performance, self-releasing slag, very low spatter formation and seam oxidation, finely rippled weld pattern with good wetting behaviour and even, reliable fusion penetration. In addition to the significant savings in time and costs of processing techniques, including the lower requirement for cleaning and pickling, BÖHLER guarantees a high level of quality and highly reliable avoidance of welding defects. The weld metal is cryogenic down to -196 °C and resists intergranular corrosion up to +350 °C. BÖHLER EAS 2-FD 0.9 mm is particularly suitable for joint welding of thin sheet (approx. 1.5 mm, in position from 5.0 mm). The nature of the slag has been designed so that this dimension can be used in all positions. The  $\varnothing$  1.2 mm electrode can be used for welding with wall thicknesses from about 3 mm.

## Base materials

1.4306 X2CrNi19-11, 1.4301 X5CrNi18-10, 1.4311 X2CrNi18-10, 1.4312 GX10CrNi18-8, 1.4541 X6CrNiTi18-10, 1.4546 X5CrNiNb18-10, 1.4550 X6CrNiNb18-10 AISI 304, 304L, 304LN, 302, 321, 347, ASTM A157 Gr. C9, A320 Gr. B8C or D

## Typical composition of all-weld metal (Wt-%)

C	Si	Mn	Cr	Ni
0,03	0,7	1,5	19,8	10,5

## Mechanical properties of all-weld metal

Heat Treatment	Yield strength 0,2%	Tensile strength	Elongation ( $L_0=5d_0$ )	Impact values in J CVN	
	MPa	MPa	%	+20°C:	-196°C:
untreated	380	560	40	60	35

## Welding position

	Polarity = +	re-drying: - in exceptional cases: 150 C/24 h shielding gases: M1 – M3; C1 Welding with conventional MAG devices, slightly trailing torch position (angle of incidence about 80°); with 100% CO2 the voltage must be 2 V higher. The gas quantity should be 15-18 l/min.
---	--------------	---

## Dimensions(mm)

## Amperage A

0,9

100-160

1,2

125-280

1,6

200-350

## Approvals and certificates

TÜV-D (5348.), DB (43.014.14), CWB (E308LT0-1(4)), GL (4550 (C1, M21)), SEPROZ, CE

**Classifications**

high-alloyed rutile

EN ISO 17633-A:

AWS A5.22:

T 19 9 L P M21 1 ; T 19 9 L P C 1 1

E308LT1-4 ; E308LT1-1

**Characteristics and field of use**

BÖHLER EAS 2 PW-FD is a strip alloyed flux cored wire with a rutile slag characteristic for position welding of austenitic CrNi steels. The support provided by the fast-hardening slag allows out-of-position welding with high current magnitudes and high welding speeds. The fine droplet, low-spatter, very powerfully welding spray arc, the reliable fusion penetration, the self-releasing slag and the effectively wetting seam formation result in a high weld quality at the same time as short welding times. Additional advantages to its application result from the ease of handling, the low heat input due to the high welding speed, and the small amounts of cleaning and pickling required. BÖHLER EAS 2-FD is preferred for flat and horizontal welding positions (PA, PB). The weld metal is cryogenic down to -196 °C and resists intergranular corrosion up to +350 °C.

**Base materials**

1.4306 X2CrNi19-11, 1.4301 X5CrNi18-10, 1.4311 X2CrNi18-10, 1.4312 GX10CrNi18-8, 1.4541 X6CrNiTi18-10, 1.4546 X5CrNiNb18-10, 1.4550 X6CrNiNb18-10 AISI 304, 304L, 304LN, 302, 321, 347, ASTM A157 Gr. C9, A320 Gr. B8C or D

**Typical composition of all-weld metal (Wt-%)**

C	Si	Mn	Cr	Ni
0,03	0,7	1,5	19,8	10,5

**Mechanical properties of all-weld metal**

Heat Treatment	Yield strength 0,2%	Tensile strength	Elongation ( $L_0=5d_0$ )	Impact values in J CVN	
	MPa	MPa	%	+20°C:	-196°C:
untreated	380	560	40	70	40

**Welding position**

	Polarity = +	re-drying: - in exceptional cases: 150 C/24 h shielding gases: M1 – M3; C1 Welding with conventional MAG devices, slightly trailing torch position (angle of incidence about 80°), slight weaving of the torch is recommended in all positions. With 100% CO <sub>2</sub> the voltage must be raised by 2 V. The gas quantity should be 15-18 l/min.
---	--------------	---

Dimensions(mm)	Amperage A
1,2	100-220
1,6	175-260

**Approvals and certificates**

TÜV-D (09117.), DB (43.014.23), CWB (E308LT1-1(4)), GL (4550S (C1,M21)), SEPROZ, CE

# Thermanit TG 308 L

Flux cored wire

<b>Classifications</b>	high-alloyed rutile	
EN ISO 17633-A:	AWS A5.22:	
T 19 9 L R M 3 ; T 19 9 L R C 3	E308LT0-4 ; E308LT0-1	

## Characteristics and field of use

Thermanit TG 308 L is an austenitic CrNi flux cored wire with rutile slag characteristic. It is suited for GMAW welding with mixed gas M21 and C1 acc. to EN ISO 14175 on matching and similar, non stabilized and stabilized corrosion resistant CrNi(N) steels/cast steel grades. The weld metal is stainless and provides good resistance to nitric acid and intercrystalline corrosion – wet corrosion up to 350 °C (662 °F), cold toughness down to -196 °C (-320.8 °F) and resistance to scaling up to 800 °C (1472 °F). Weldable almost spatter free and due to the very slow freezing rutile slag the weld metal shows very fine and smooth bead appearance. Very good slag detachability and notch free seams with low annealing colouring, easy to clean and pickle. The root welding is proven on ceramic backing bar.

## Base materials

1.4301 – X5CrNi18-10	1.4311* – X2CrNiN18-10
1.4306 – X2CrNi19-11	1.4541 – X6CrNTi18-10
1.4308 – G-X6CrNi18-9	1.4550 – X6CrNiNb18-10
1.4552 – G-X5CrNiNb18-9	1.4948 – X6CrNi18-11

also included materials according to VdTÜV-Kennblatt 1000.26 \* Material No. 1.4311 certified only with shielding gas of group M2 according to EN ISO 14175

## Typical composition of all-weld metal (Wt-%)

C	Si	Mn	Cr	Ni
0,03	0,7	1,5	18,9	10,5

## Mechanical properties of all-weld metal

Heat Treatment	Yield strength 0,2%	Tensile strength	Elongation (L <sub>0</sub> =5d <sub>0</sub> )	Impact values in J CVN	
	MPa	MPa	%	at RT	-196 °C:
untreated	350	560	35	47	32

## Welding position

	Polarity = +	Shielding gas (EN ISO 14175) M21 and C1, Consumption : 15 - 20 l/min.
---	--------------	--

Dimensions(mm)	Amperage A
0,9	100-180
1,2	120-280
1,6	200-350

## Approvals and certificates

TÜV (Certificate No. 7538) DB (Reg. form No. 43.132.15) GL, UDT

**A FC - 09L** Flux cored wire

<b>Classifications</b>	high-alloyed rutile	
EN ISO 17633-A:	AWS A5.22:	
T 23 12 L R M/C 3	E309LT0-4 ; E309LT0-1	

**Characteristics and field of use**

Avesta FCW-2D 309L is a high-alloy wire, primarily intended for surfacing low-alloy steels and for dissimilar welds between mild steel and stainless steels. It can also be used for welding some high temperature steels, such as 1.4833/ASTM 309S. Avesta FCW-2D 309L provides excellent weldability in flat as well as horizontal/vertical position. Welding in vertical-up and overhead positions is preferably done using FCW 309L-PW. FCW-2D 309L diam. 0.9 mm can be welded in all positions. Avesta FCW-2D 309L should be welded using direct current positive polarity (DC+) with a recommended wire stick-out of 15 – 20 mm.

**Corrosion resistance**

Superior to type 308L fillers. When used for overlay welding on mild steel a corrosion resistance equivalent to that of 1.4301/304 is obtained already in the first layer. Ferrite 15 FN; WRC-92

**Base materials**

For welding steels such as					
Outokumpu	EN	ASTM	BS	NF	SS
Avesta 309L is primarily used for surfacing unalloyed or low-alloy steels and when joining non-molybdenum-alloyed stainless and carbon steels.					

**Typical composition of all-weld metal (Wt-%)**

C	Si	Mn	Cr	Ni
0, 025	0,7	1,4	22,8	12,5

**Mechanical properties of all-weld metal**

Heat Treatment	Yield strength 0,2%	Tensile strength	Elongation (L <sub>0</sub> =5d <sub>0</sub> )	Impact values in J CVN	
	MPa	MPa	%	+20°C:	-60°C:
untreated	400	540	35	60	45

**Operating data**

	Polarity = +	Shielding gas Ar + 15 – 25% CO <sub>2</sub> offers the best weldability, but 100% CO <sub>2</sub> can also be used (voltage should be increased by 2V). Gas flow rate 20–25 l/min.
---	--------------	--

Dimensions (mm)	Amperage A
0,9	100-160
1,2	125-280
1,6	200-350

A FC 09L-P		Flux cored wire			
<b>Classifications</b>		high-alloyed rutile			
EN ISO 17633-A:	AWS A5.22:				
T 23 12 L P M/C 1	E309LT1-4 ; E309LT1-1				
<b>Characteristics and field of use</b>					
<p>Avesta FCW 309L-PW is a high-alloy wire primarily intended for surfacing on low-alloy steels and for dissimilar welds between mild steel and stainless steels. It can also be used for welding some high temperature steels, such as 1.4833/ASTM 309S. Avesta FCW 309L-PW has a stronger arc and a faster freezing slag compared to the 2D type. It is designed for all-round welding and can be used in all positions without changing the parameter settings. Avesta FCW 309L-PW should be welded using direct current positive polarity (DC+) with a recommended wire stick-out of 15 – 20 mm.</p> <p><b>Corrosion resistance:</b> Superior to type 308L fillers. When used for overlay welding on mild steel a corrosion resistance equivalent to that of 1.4301/304 is obtained already in the first layer.</p>					
<b>Base materials</b>					
For welding steels such as					
Outokumpu	EN	ASTM	BS	NF	SS
Avesta 309L is primarily used for surfacing unalloyed or low-alloy steels and when joining non-molybdenum-alloyed stainless and carbon steels.					
<b>Typical analysis of all-weld metal (Wt-%)</b>					
C	Si	Mn	Cr	Ni	
0, 025	0,7	1,5	23,0	12,2	
<b>Mechanical properties of all-weld metal</b>					
Heat Treatment	Yield strength 0,2%	Tensile strength	Elongation (L <sub>0</sub> =5d <sub>0</sub> )	Impact values in J CVN	
	MPa	MPa	%	+20°C:	
untreated	390	550	35	55	
<b>Operating data</b>					
	Polarity = +		Shielding gas Ar + 15 – 25% CO <sub>2</sub> offers the best weldability, but 100% CO <sub>2</sub> can also be used (voltage should be increased by 2V). Gas flow rate 20–25 l/min.		
<b>Dimensions (mm)</b>		<b>Amperage A</b>			
1,2		150-240			

## Classifications

high-alloyed rutile

EN ISO 17633-A:

AWS A5.22:

T 23 12 L R M21 (C1) 3

E309LT0-4 ; E309LT0-1

## Characteristics and field of use

Rutile, strip alloyed, flux cored wire for welding austenite-ferrite joints and for weld claddings primarily in the flat and horizontal welding positions. The easy handling and high deposition rate result in high productivity with excellent welding behaviour, self-releasing slag, low spatter formation and seam oxidation, finely rippled weld seams with good wetting behaviour and even, reliable fusion penetration. The weld metal is suitable for operating temperatures between -60°C and +300°C. BÖHLER CN 23/12-FD Ø0.9 mm is particularly suitable for joint welding of thin sheet (approx. 1.5 mm, in position from 5.0 mm). The nature of the slag has been designed so that this dimension can be used in all positions. The Ø1.2 mm electrode can be used for welding with wall thicknesses from about 3 mm.

## Base materials

Joints: of and between high-strength, unalloyed and alloyed quenched and tempered steels, stainless, ferritic Cr and austenitic Cr-Ni steels, austenitic manganese steels and weld claddings: for the first layer of chemically resistant weld claddings on the ferritic-pearlitic steels used for boiler and pressure vessel construction up to fine-grained structural steel S500N, and for the creep resistant fine-grained structural steels 22NiMoCr4-7, 20MnMoNi5-5 and GS-18NiMoCr 3 7

## Typical composition of all-weld metal (Wt-%)

C	Si	Mn	Cr	Ni
0,03	0,7	1,4	23,0	12,5

## Mechanical properties of all-weld metal

Heat Treatment	Yield strength 0,2%	Tensile strength	Elongation ( $L_0=5d_0$ )	Impact values in J CVN	
	MPa	MPa	%	+20°C:	-60°C:
untreated	400	540	33	60	45

## Welding position

	Polarity = +	re-drying: - in exceptional cases: 150 C/24 h shielding gases: Argon + 15-25% CO2 100% CO2 The gas quantity should be 15-18 l/min. Slightly trailing torch position (angle of incidence about 80°). It is recommended that the voltage is increased by 2 V if the shielding gas is 100% CO2. Preheating and interpass temperature as required by the base metal.
---	--------------	--

## Dimensions(mm)

Dimensions(mm)	Amperage A
0,9	100-160
1,2	125-280
1,6	200-350

## Approvals and certificates

TÜV-D (5350.), DB (43.014.16), CWB (E309LT0-1(4)), GL (4332 (C1, M21)), LR (DX, CMn/SS), SEPROZ, CE, RINA (309L5), DNV

BÖHLER CN		P -F		Flux cored wire	
Classifications			high-alloyed rutile		
EN ISO 17633-A:		AWS A5.22:			
T 23 12 L P M21 1 ; T 23 12 L P C1 1		E309LT1-4 ; E309LT1-1			
Characteristics and field of use					
<p>Rutile, strip alloyed, flux cored wire with fast freezing slag for position welding of austenite-ferrite joints, and for the first layer of weld claddings of unalloyed and low-alloy Base materials. The support provided by the fast-hardening slag allows out-of-position welding with high current magnitudes and high welding speeds. The fine droplet, low-spatter, very intense spray arc, the reliable fusion penetration, the self-releasing slag and the good wetting behaviour result in a high weld quality at the same time as short welding times. Additional advantages to its application are the ease of handling, the low heat input resulting from the high welding speed, and the small amounts of cleaning and pickling required. BÖHLER CN 23/12-FD should be used for flat and horizontal welding positions (PA, PB). The weld metal is suitable for operating temperatures between -60°C and +300°C.</p>					
Base materials					
<p>Joints: of and between high-strength, unalloyed and alloyed quenched and tempered steels, stainless, ferritic Cr and austenitic Cr-Ni steels, austenitic manganese steels and weld claddings: for the first layer of chemically resistant weld claddings on the ferritic-pearlitic steels used for boiler and pressure vessel construction up to fine-grained structural steel S500N, and for the creep resistant fine-grained structural steels 22NiMoCr4-7, 20MnMoNi5-5 and GS- 18NiMoCr 3 7</p>					
Typical composition of all-weld metal (Wt-%)					
C	Si	Mn	Cr	Ni	
0,03	0,7	1,4	23,0	12,5	
Mechanical properties of all-weld metal					
Heat Treatment	Yield strength 0,2%	Tensile strength	Elongation (L <sub>0</sub> =5d <sub>0</sub> )	Impact values in J CVN	
	MPa	MPa	%	+20°C:	-60°C:
untreated	400	540	33	65	50
Welding position					
		re-drying: - in exceptional cases: 150 C/24 h shielding gases: Argon + 15-25% CO2 100% CO2 The gas quantity should be 15-18 l/min. Slightly trailing torch position (angle of incidence about 80°), slight weaving of the torch is recommended in all positions. It is recommended that the voltage is increased by 2 V if the shielding gas is 100% CO2. Preheating and interpass temperature as required by the base metal.			
Dimensions(mm)			Amperage A		
1,2			100-220		
1,6			175-260		
Approvals and certificates					
TÜV-D (09115.), DB (43.014.22), ABS (E 309 LT 1-1(4)), LR (DXV and O, CMn/SS), GL (4332S{C1,M21}), CWB (E309LT0-1(4)), SEPROZ, DNV, RINA; ÖBB, CE					

<b>Classifications</b>	high-alloyed rutile	
EN ISO 17633-A:	AWS A5.22:	
T 23 12 L R M 3 ; T 23 12 L R C 3	E309LT0-4 ; E309LT0-1	

### Characteristics and field of use

Thermanit TG 309 L is an austenitic CrNi flux cored wire with rutile slag characteristic. It is suited for GMAW welding with mixed gas M21 and C1 acc. to EN ISO 14175. For joint welding of high-alloyed CrNi(Mo, N) steels/cast steel grades with unalloyed/low alloyed steels (austenite ferrite joints) with a maximum application temperature of 300 °C (572 °F). It is also suited for joint welding of high alloyed CrNi(Mo, N) steels/cast steel grades with stainless and heat-resistant Cr steels/cast steel grades. For intermediate layers when welding the clad side of plates and cast materials clad with non stabilized and stabilized CrNi(Mo, N) austenitic metal. The weld metal is stainless (wet corrosion up to 350 °C (662 °F)). Weldable almost spatter-free and due to the very slow freezing slag the weld metal shows fine and smooth bead appearance. Very good slag detachability and notch free seams with low annealing colouring, easy to clean and pickle. Root welding is proven on ceramic backing strips.

### Base materials

1.4301 – X5CrNi18-10	1.4436 – X5CrNiMo17-13-3
1.4306 – X2CrNi19-11	1.4541 – X6CrNiTi18-10
1.4308 – G-X6CrNi18-9	1.4550 – X6CrNiNb18-10
1.4401 – X5CrNi Mo17-12-2	1.4552 – G-X5CrNiNb18-9
1.4404 – X2CrNiMo17-13-2	1.4571 – X6CrNiMoTi17-12-2
1.4408 – G-X6CrNiMo	1.4580 – X6CrNiMoNb17-12-2
1.4435 – X2CrNiMo18-14-3	1.4581 – G-XCrNiMoNb18-10

### Typical composition of all-weld metal (Wt-%)

C	Si	Mn	Cr	Ni
0,03	0,7	1,4	23,0	12,5

### Mechanical properties of all-weld metal

Heat Treatment	Yield strength 0,2%	Tensile strength	Elongation (L <sub>0</sub> =5d <sub>0</sub> )	Impact values in J CVN	
	MPa	MPa	%	+20°C:	-60°C:
untreated	380	540	35	47	32

### Welding position

	Polarity = +	Shielding gas (EN ISO 14175) M21 and C1, Consumption: 15 - 20 l/min.
---	--------------	--

Dimensions(mm)	Amperage A
0,9	100-180
1,2	120-280
1,6	200-350

### Approvals and certificates

TÜV (Certificate No. 07540) DB (Reg. form No. 43.132.14) GL UDT



A	FC -	6L KR	Flux cored wire
<b>Classifications</b>		high-alloyed rutile	
EN ISO 17633-A:	AWS A5.22:		
T 19 12 3 L R M/C 3	E316LT0-4 ; E316LT0-1		

#### Characteristics and field of use

Avesta FCW 316L is designed for welding 1.4436/ASTM 316 type stainless steels. It is also suitable for welding steels that are stabilized with titanium or niobium, such as 1.4571/ASTM 316Ti for service temperatures not exceeding 400°C. Avesta FCW-2D 316L/SKR provides excellent weldability in flat as well as horizontal/vertical position. Welding in vertical-up and overhead positions is preferably done using FCW 316L/SKR-PW. FCW-2D 316L/SKR diam. 0.9 mm can be welded in all positions. Avesta FCW-2D 316L/SKR should be welded using direct current positive polarity (DC+) with a recommended wire stick-out of 15 – 20 mm.

#### Corrosion resistance

Excellent resistance to general, pitting and intercrystalline corrosion in chloride containing environments. Intended for severe service conditions, e.g. in dilute hot acids.

#### Base materials

For welding steels such as					
Outokumpu	EN	ASTM	BS	NF	SS
4436	1.4436	316	316S33	Z7 CND 18-12-03	2343
4432	1.4432	316L	316S13	Z3 CND 17-12-03	2353
4429	1.4429	S31653	316S63	Z3 CND 17-12 Az	2375
4571	1.4571	316Ti	320S31	Z6 CNDT 17-12	2350

#### Typical analysis of all-weld metal (Wt-%)

C	Si	Mn	Cr	Ni	Mo
0, 025	0,7	1,5	19,0	12,0	2,7

Ferrite 10 FN; WRC-92

#### Mechanical properties of all-weld metal

Heat Treatment	Yield strength	Tensile strength	Elongation	Impact values		
	0,2%		( $L_0=5d_0$ )	in J CVN		
	MPa	MPa	%	+20°C:	-40°C:	-196°C
untreated	400	560	33	55	50	28

#### Operating data

	Polarity = +	shielding gas: Ar + 15 – 25% CO2 offers the best weldability, but 100% CO2 can also be used (voltage should be increased by 2V). Gas flow rate 20 – 25 l/min.
---	--------------	---

Dimensions (mm)	Amperage A
0,9	100-160
1,2	125-280
1,6	200-350

A FC 6L KR-P Flux cored wire

<b>Classifications</b>	high-alloyed rutile	
EN ISO 17633-A:	AWS A5.22:	
T 19 12 3 L P M/C 1	E316LT1-4 ; E316LT1-1	

**Characteristics and field of use**

Avesta FCW 316L/SKR-PW is designed for welding 1.4436/ASTM 316 type stainless steels. It is also suitable for welding steels that are stabilised with titanium or niobium, such as 1.4571/ASTM 316Ti for service temperatures not exceeding 400°C. Avesta FCW 316L/SKR-PW has a stronger arc and a faster freezing slag compared to the 2D type. It is designed for all-round welding and can be used in all positions without changing the parameter settings. Weldability is excellent in the vertical-up and overhead welding positions. Avesta FCW 316L/SKR-PW should be welded using direct current positive polarity (DC+) with a recommended wire stick-out of 15 – 20 mm.

**Corrosion resistance**

Excellent resistance to general, pitting and intercrystalline corrosion in chloride containing environments. Intended for severe service conditions, e.g. in dilute hot acids.

**Base materials**

For welding steels such as					
Outokumpu	EN	ASTM	BS	NF	SS
4436	1.4436	316	316S33	Z7 CND 18-12-03	2343
4432	1.4432	316L	316S13	Z3 CND 17-12-03	2353
4429	1.4429	S31653	316S63	Z3 CND 17-12 Az	2375
4571	1.4571	316Ti	320S31	Z6 CNDT 17-12	2350

**Typical analysis of all-weld metal (Wt-%)**

C	Si	Mn	Cr	Ni	Mo
0,025	0,8	1,5	18,8	11,8	2,7

Ferrite 10 FN; WRC-92

**Mechanical properties of all-weld metal**

Heat Treatment	Yield strength 0,2%	Tensile strength	Elongation (L <sub>0</sub> =5d <sub>0</sub> )	Impact values in J CVN	
	MPa	MPa	%	+20°C:	-40°C:
untreated	400	560	37	60	55

**Operating data**

	Polarity = +	Shielding gas Ar + 15 – 25% CO2 offers the best weldability, but 100% CO2 can also be used (voltage should be increased by 2V). Gas flow rate 20–25 l/min.
---	--------------	--

Dimensions (mm)	Amperage A
1,2	150-240

**Classifications**

high-alloyed rutile

EN ISO 17633-A:

AWS A5.22:

T 19 12 3 LR M21 (C1) 3

E316LT0-4 ; E316LT0-1

**Characteristics and field of use**

Rutile, strip alloyed, flux cored wire for MAG welding of austenitic CrNiMo steels, primarily in flat and horizontal welding positions. The easy handling and high deposition rate of BÖHLER EAS 4 M-FD result in high productivity with excellent welding performance, self-releasing slag, very low spatter formation and seam oxidation, finely rippled weld pattern with good wetting behaviour and even, reliable fusion penetration. In addition to the significant savings in time and costs of processing techniques, including the lower requirement for cleaning and pickling, BÖHLER EAS 4 M-FD allows a high level of quality and highly reliable avoidance of welding defects. The weld metal is cryogenic down to -120 °C and resists intergranular corrosion up to +400 °C. BÖHLER EAS 4 M-FD 0.9 mm is particularly suitable for joint welding of thin sheet (approx. 1.5 mm, in position from 5.0 mm). The nature of the slag has been designed so that this dimension can be used in all positions. The  $\varnothing$  1.2 mm electrode can be used for welding with wall thicknesses from about 3 mm.

**Base materials**

1.4401 X5CrNiMo17-12-2, 1.4404 X2CrNiMo17-12-2, 1.4435 X2CrNiMo18-14-3, 1.4436 X3CrNiMo17-13-3, 1.4571 X6CrNiMoTi17-12-2, 1.4580 X6CrNiMoNb17-12-2, 1.4583 X10CrNiMoNb18-12, 1.4409 GX2CrNiMo 19-11-2 UNS S31603, S31653; AISI 316L, 316Ti, 316Cb

**Typical composition of all-weld metal (Wt-%)**

C	Si	Mn	Cr	Ni	Mo
0,03	0,7	1,5	19,0	12,0	2,7

**Mechanical properties of all-weld metal**

Heat Treatment	Yield strength 0,2%	Tensile strength	Elongation ( $L_0=5d_0$ )	Impact values in J CVN	
				+20°C:	-120°C:
untreated	400	560	38	55	35

**Welding position**

	Polarity = +	re-drying: - in exceptional cases: 150 C/24 h shielding gases: M1 – M3; C1 Welding with conventional MAG devices, slightly trailing torch position (angle of incidence about 80°); with 100% CO2 the voltage must be 2 V higher. The gas quantity should be 15-18 l/min.
---	--------------	---

Dimensions(mm)	Amperage A
0,9	100-160
1,2	125-280
1,6	200-350

**Approvals and certificates**

TÜV-D (5349), DB (43.014.15), CWB (E316LT0-1(4)), GL (4571 (C1, M21)), LR (DX BF, 316L S), SEPROZ, CE, DNV

<b>Classifications</b>	high-alloyed rutile	
EN ISO 17633-A:	AWS A5.22:	
T 19 12 3 LP M21 1 ; T 19 12 3 LP C1 1	E316LT1-4 ; E316LT1-1	

**Characteristics and field of use**

BÖHLER EAS 4 PW-FD is a strip alloyed flux cored wire with a rutile slag characteristic for position welding of austenitic CrNiMo steels. The support provided by the fast-hardening slag allows out-of-position welding with high current magnitudes and high welding speeds. The fine droplet, low-spatter, very powerfully welding spray arc, the reliable fusion penetration, the self-releasing slag and the effectively wetting seam formation result in a high weld quality at the same time as short welding times. Additional advantages to its application result from the ease of handling, the low heat input due to the high welding speed, and the small amounts of cleaning and pickling required. BÖHLER EAS 4 M-FD is preferred for flat and horizontal welding positions (PA, PB). The weld metal is cryogenic down to -120 °C and resists intergranular corrosion up to +400 °C.

**Base materials**

1.4401 X5CrNiMo17-12-2, 1.4404 X2CrNiMo17-12-2, 1.4435 X2CrNiMo18-14-3, 1.4436 X3CrNiMo17-13-3, 1.4571 X6CrNiMoTi17-12-2, 1.4580 X6CrNiMoNb17-12-2, 1.4583 X10CrNiMoNb18-12, 1.4409 GX2CrNiMo 19-11-2 UNS S31603, S31653; AISI 316L, 316Ti, 316Cb

**Typical composition of all-weld metal (Wt-%)**

C	Si	Mn	Cr	Ni	Mo
0,03	0,7	1,5	19,0	12,0	2,7

**Mechanical properties of all-weld metal**

Heat Treatment	Yield strength	Tensile strength	Elongation	Impact values	
	0,2%		( $L_0=5d_0$ )	in J CVN	
	MPa	MPa	%	+20°C:	-120°C:
untreated	400	560	38	65	45

**Welding position**

	Polarity = +	re-drying: - in exceptional cases: 150 C/24 h shielding gases: M1 – M3; C1 Welding with conventional MAG devices, slightly trailing torch position (angle of incidence about 80°), slight weaving of the torch is recommended in all positions. With 100% CO2 the voltage must be raised by 2 V. The gas quantity should be 15-18 l/min.
---	--------------	---

<b>Dimensions(mm)</b>	<b>Amperage A</b>
1,2	100-220
1,6	175-260

**Approvals and certificates**

TÜV-D (09118), DB (43.014.24), CWB (E316LT1-1(4)), LR (DXV and O, BF 316LS), GL (4571S (C1,M21)), SEPROZ, CE, DNV

## Classifications

high-alloyed rutile

EN ISO 17633-A:

AWS A5.22:

T Z19 12 3 LP M21 1 ; T Z19 12 3 LP C1 1

E316LT1-4 ; E316LT1-1

## Characteristics and field of use

Rutile flux cored wire with controlled ferrite content (3-6 FN), particularly for applications in which special resistance to low temperatures and lateral expansion down to  $-196^{\circ}\text{C}$  is specified, e.g. for LNG applications. The wire's slag system guarantees exceptional position welding properties and high welding speeds.

## Base materials

1.4401 X5CrNiMo17-12-2, 1.4404 X2CrNiMo17-12-2, 1.4435 X2CrNiMo18-14-3, 1.4436 X3CrNiMo17-13-3, 1.4571 X6CrNiMoTi17-12-2, 1.4580 X6CrNiMoNb17-12-2, 1.4583 X10CrNiMoNb18-12, 1.4409 GX2CrNiMo 19-11-2 UNS S31603, S31653; AISI 316L, 316Ti, 316Cb

## Typical composition of all-weld metal (Wt-%)

C	Si	Mn	Cr	Ni	Mo
0,03	0,7	1,4	18,1	12,5	2,1

## Mechanical properties of all-weld metal

Heat Treatment	Yield strength 0,2%	Tensile strength	Elongation ( $L_0=5d_0$ )	Impact values in J CVN	
	MPa	MPa	%	+20°C:	-196°C:
untreated	390	550	40	75	45

## Welding position



Polarity = +

re-drying: -  
in exceptional cases: 150 C/24 h  
shielding gases: M1 – M3; C1  
Welding with conventional MAG devices, slightly trailing torch position (angle of incidence about  $80^{\circ}$ ); with 100% CO<sub>2</sub> the voltage must be 2 V higher. The gas quantity should be 15-18 l/min.

Dimensions(mm)

Amperage A

1,2

100-220

# Thermanit TG 316 L

Flux cored wire

Classifications		high-alloyed rutile
EN ISO 17633-A:	AWS A5.22:	
T 19 12 3 L R M 3 ; T 19 12 3 L R C 3	E316LT0-4 ; E316LT0-1	

## Characteristics and field of use

Thermanit TG 316 L is an austenitic CrNiMo flux cored wire with rutile slag characteristic. It is suited for GMAW welding with mixed gas M21 and C1 acc. to EN ISO 14175 for joining of matching and similar, non stabilized and stabilized, corrosion resistant CrNi(N) and CrNiMo(N) steels/cast steel grades. The weld metal is stainless and resistant to intercrystalline corrosion (wet corrosion up to 400 °C / 752 °F), cold toughness down to -120 °C (-184 °F) and resistant to scaling up to 800 °C (1472 °F). Thermanit TG 316 L provides almost spatter free welding behaviour and due to the slow freezing rutile slag, the weld metal shows very fine and smooth bead appearance. Very good slag detachability and notch free seams with low annealing colouring, easy to clean and pickle. Root welding is proven on ceramic backing strips.

## Base materials

1.4301 – X5CrNi18-10	1.4541 – X6CrNiTi18-10
1.4306 – X2CrNi19-11	1.4550 – X6CrNiNb18-10
1.4308 – G-X6CrNi18-9	1.4552 – G-X5CrNiNb18-9
1.4401 – X5CrNi Mo17-12-2	1.4583 – X10CrNiMoNb18-12
1.4404 – X2CrNiMo17-13-2	1.4571 – X6CrNiMoTi17-12-2
1.4408 – G-X6CrNiMo18-10	1.4573 – X10CrNiMoTi18-12
1.4435 – X2CrNiMo18-14-3	1.4580 – X6CrNiMoNb17-12-2
1.4436 – X5CrNiMo17-13-3	1.4581 – G-XCrNiMoNb18-10

## Typical composition of all-weld metal (Wt-%)

C	Si	Mn	Cr	Mo	Ni
0,03	0,7	1,5	19,0	2,7	12,0

## Mechanical properties of all-weld metal

Heat Treatment	Yield strength	Tensile strength	Elongation	Impact values	
	0,2%		( $L_0=5d_0$ )	in J CVN	
	MPa	MPa	%	at RT	-120°C:
untreated	350	560	35	47	32

## Welding position

	Polarity = +	Shielding gas (EN ISO 14175) M21 and C1, Consumption: 15 - 20 l/min.
---	--------------	---

Dimensions(mm)	Amperage A
0,9	100-180
1,2	120-280
1,6	200-350

## Approvals and certificates

TÜV (Certificate No. 7539) DB (Reg. form No. 43.132.16) GL, UDT

A FC - 47 MVN		Flux cored wire			
<b>Classifications</b>		high-alloyed rutile			
EN ISO 17633-A:	AWS A5.22:				
T 19 9 Nb R M/C 3	E347T0-4 ; E347T0-1				
<b>Characteristics and field of use</b>					
<p>Avesta FCW-2D 347/MVNB is a Nb-stabilised Cr-Ni flux-cored wire for welding steels that are stabilised with titanium or niobium, such as 1.4541/ASTM 321. A stabilised weldment has improved high temperature properties, e.g. creep resistance, compared to low-carbon non-stabilised grades. This wire is primarily used for applications with service temperatures above 400°C. Avesta FCW-2D 347/MVNB provides excellent weldability in flat as well as horizontal/vertical position. Welding in vertical-up and overhead positions is preferably done using FCW 347/MVNB-PW. Avesta FCW-2D 347/MVNB should be welded using direct current positive polarity (DC+) with a recommended wire stick-out of 15 – 20 mm.</p> <p><b>Corrosion resistance:</b> Generally none. 347 type FCW can be used for cladding, which normally requires stress relieving at around 590°C. Such a heat treatment will reduce the ductility of the weld at room temperature. Always consult expertise before performing post-weld heat treatment.</p>					
<b>Base materials</b>					
For welding steels such as					
Outokumpu	EN	ASTM	BS	NF	SS
4541	1.4541	321	321S31	Z6 CNT 18-10	2337
-	1.4550	347	347S31	Z6 CNNb 18-10	2338
<b>Typical analysis of all-weld metal (Wt-%)</b>					
C	Si	Mn	Cr	Ni	Nb
0,03	0,6	1,6	19,4	10,5	8xC
Ferrite 7 FN; WRC-92					
<b>Mechanical properties of all-weld metal</b>					
Heat Treatment	Yield strength 0,2%	Tensile strength	Elongation ( $L_0=5d_0$ )	Impact values in J CVN	
	MPa	MPa	%	+20°C:	
untreated	420	600	35	75	
<b>Operating data</b>					
	Polarity = +		shielding gas: Ar + 15 – 25% CO <sub>2</sub> offers the best weldability, but 100% CO <sub>2</sub> can also be used (voltage should be increased by 2V). Gas flow rate 20 – 25 l/min.		
<b>Dimensions (mm)</b>		<b>Amperage A</b>			
1,2		125-280			

Classifications		high-alloyed rutile
EN ISO 17633-A:	AWS A5.22:	
T 19 9 Nb R M21 3 ; T 19 9 Nb R C1 3	E347T0-4 ; E347T0-1	

#### Characteristics and field of use

Rutile, strip alloyed, flux cored wire for MAG welding of stabilised, austenitic CrNi steels. For application in all branches of industry where same-type steels and ferritic 13% chrome steels are welded. Typical fields of application include the construction of chemical apparatus and containers, the textile and cellulose industries, dye works and so on. The easy handling and high deposition rate of BÖHLER SAS 2-FD result in high productivity with excellent welding performance, selfreleasing slag, very low spatter formation and seam oxidation, finely rippled weld pattern with good wetting behaviour and even, reliable fusion penetration. In addition to the significant savings in time and costs of processing techniques, including the lower requirement for cleaning and pickling, BÖHLER SAS 2-FD allows a high level of quality and highly reliable avoidance of welding defects. The weld metal is cryogenic down to -196 °C and resists intergranular corrosion up to +400 °C.

#### Base materials

1.4550 X6CrNiNb18-10, 1.4541 X6CrNiTi18-10, 1.4552 GX5CrNiNb19-11, 1.4301 X5CrNi18-10, 1.4312 GX10CrNi18-8, 1.4546 X5CrNiNb18-10, 1.4311 X2CrNi18-10, 1.4306 X2CrNi19-11  
 AISI 347, 321,302, 304, 304L, 304LN, ASTM A296 Gr. CF 8 C, A157 Gr. C9, A320 Gr. B8C or D

#### Typical composition of all-weld metal (Wt-%)

C	Si	Mn	Cr	Ni	Nb
0,03	0,6	1,4	19,0	1,4	+

#### Mechanical properties of all-weld metal

Heat Treatment	Yield strength	Tensile strength	Elongation	Impact values		
	0,2%		( $L_0=5d_0$ )	in J CVN		
	MPa	MPa	%	+20°C:	-196°C:	
untreated	420	600	35	75	45	

#### Welding position

	Polarity = +	<p>re-drying: -            in exceptional cases: 150 °C/24 h            shielding gases: M1 – M3; C1            Welding with conventional MAG devices, slightly trailing torch position (angle of incidence about 80°); with 100% CO<sub>2</sub> the voltage must be 2 V higher. The gas quantity should be 15-18 l/min.</p>
---	--------------	--

Dimensions(mm)	Amperage A
1,2	125-280
1,6	200-350

#### Approvals and Certificates

TÜV-D (09740.), SEPROZ, CE



BÖHLER A P -F

Flux cored wire

**Classifications**

high-alloyed rutile

EN ISO 17633-A:

AWS A5.22:

T 19 9 Nb P M21 1 ; T 19 9 Nb P C1 1

E347T1-4 ; E347T1-1

**Characteristics and field of use**

BÖHLER SAS 2 PW-FD is a strip alloyed flux cored wire with a rutile slag characteristic for position welding of stabilised, austenitic CrNi steels. The support provided by the fast-hardening slag allows out-of-position welding with high current magnitudes and high welding speeds. For application in all branches of industry where same-type steels and ferritic 13% chrome steels are welded. Typical fields of application include the construction of chemical apparatus and containers, the textile and cellulose industries, dye works and so on. The fine droplet, lowspatter, very powerfully welding spray arc, the reliable fusion penetration, the self-releasing slag and the effectively wetting seam formation result in a high weld quality at the same time as short welding times. Additional advantages to its application result from the ease of handling, the low heat input due to the high welding speed, and the small amounts of cleaning and pickling required. BÖHLER SAS 2-FD is preferred for flat and horizontal welding positions (PA, PB). The weld metal is cryogenic down to -120°C and resists intergranular corrosion up to +400 C.

**Base materials**

1.4550 X6CrNiNb18-10, 1.4541 X6CrNiTi18-10, 1.4552 GX5CrNiNb19-11, 1.4301 X5CrNi18-10, 1.4312 GX10CrNi18-8, 1.4546 X5CrNiNb18-10, 1.4311 X2CrNiN18-10, 1.4306 X2CrNi19-11  
 AISI 347, 321,302, 304, 304L, 304LN; ASTM A296 Gr. CF 8 C, A157 Gr. C9, A320 Gr. B8C or D

**Typical composition of all-weld metal (Wt-%)**

C	Si	Mn	Cr	Ni	Nb
0,03	0,7	1,4	19,0	10,4	+

**Mechanical properties of all-weld metal**

Heat Treatment	Yield strength 0,2%	Tensile strength	Elongation ( $L_0=5d_0$ )	Impact values in J CVN	
	MPa	MPa	%	+20°C:	-120°C:
untreated	420	600	35	75	38

**Welding position**

	Polarity = +	re-drying: - in exceptional cases: 150 C/24 h shielding gases: M1 – M3; C1 Welding with conventional MAG devices, slightly trailing torch position (angle of incidence about 80°), slight weaving of the torch is recommended in all positions. With 100% CO2 the voltage must be raised by 2 V. The gas quantity should be 15-18 l/min.
---	--------------	---

**Dimensions(mm)****Amperage A**

1,2

100-220

**Approvals and Certificates**

TÜV-D (10059.), SEPROZ, CE

**A FC - 05** Flux cored wire

<b>Classifications</b>	high-alloyed rutile	
EN ISO 17633-A:	AWS A5.22:	
T 22 9 3 N L R M/C 3	E2209T0-4 ; E2209T0-1	

**Characteristics and field of use**

Avesta FCW-2D 2205 is primarily designed for welding duplex stainless steels such as 2205. Avesta FCW-2D 2205 provides excellent weldability in flat as well as horizontal/vertical position. Welding in vertical-up and overhead positions is preferably done using FCW 2205-PW. Avesta FCW-2D 2205 should be welded using direct current positive polarity (DC+) with a recommended wire stick-out of 15 – 20 mm. The weldability of duplex steels is excellent, but the welding should be adapted to the base material, considering fluidity, joint design, heat input etc.

**Corrosion resistance:**

Very good resistance to pitting and stress corrosion cracking in chloride containing environments. PREN >35. Meets the corrosion test requirements per ASTM G48 Methods A, B and E (22°C), ASTM G36 and NACE TM 0177 Method A.

**Base materials**

For welding steels such as					
Outokumpu	EN	ASTM	BS	NF	SS
2205	1.4462	S32205	318S13	Z3 CND 22-05 Az	2377

**Typical analysis of all-weld metal (Wt-%)**

C	Si	Mn	Cr	Ni	Mo	N
0, 025	0,7	0,9	22,9	9,2	3,2	0,13

Ferrite 45 FN; WRC-92

**Mechanical properties of all-weld metal**

Heat Treatment	Yield strength	Tensile strength	Elongation (L <sub>0</sub> =5d <sub>0</sub> )	Impact values in J CVN	
	0,2%			+20°C:	-40°C:
untreated	615	800	25	60	40

**Operating data**

	Polarity = +	shielding gas: Ar + 15 – 25% CO <sub>2</sub> offers the best weldability, but 100% CO <sub>2</sub> can also be used (voltage should be increased by 2V). Gas flow rate 20 – 25 l/min.
---	--------------	---

Dimensions (mm)	Amperage A
1,2	125-280
1,6	200-350



A FC 05-P		Flux cored wire				
<b>Classifications</b>		high-alloyed rutile				
EN ISO 17633-A:		AWS A5.22:				
T 22 9 3 N L P M/C 1		E2209T1-4 ; E2209T1-1				
<b>Characteristics and field of use</b>						
<p>Avesta FCW 2205-PW is primarily designed for welding duplex stainless steels such as 2205. Avesta FCW 2205-PW has a stronger arc and a faster freezing slag compared to the 2D type. It is designed for all-round welding and can be used in all positions without changing the parameter settings. Weldability is excellent in the vertical-up and overhead welding positions. Avesta FCW 2205-PW should be welded using direct current positive polarity (DC+) with a recommended wire stick-out of 15 – 20 mm. The weldability of duplex steels is excellent, but the welding should be adapted to the base material, considering fluidity, joint design, heat input etc.</p> <p><b>Corrosion resistance:</b> Very good resistance to pitting and stress corrosion cracking in chloride containing environments. PREN &gt;35. Meets the corrosion test requirements per ASTM G48 Methods A, B and E (22°C).</p>						
<b>Base materials</b>						
For welding steels such as						
Outokumpu	EN	ASTM	BS	NF	SS	
2205	1.4462	S32205	318S13	Z3 CND 22-05 Az	2377	
<b>Typical analysis of all-weld metal (Wt-%)</b>						
C	Si	Mn	Cr	Ni	Mo	N
0, 025	0,7	1,0	23,0	9,1	3,2	0,13
Ferrite 40 FN; WRC-92						
<b>Mechanical properties of all-weld metal</b>						
Heat Treatment	Yield strength 0,2%	Tensile strength	Elongation ( $L_0=5d_0$ )	Impact values in J CVN		
	MPa	MPa	%	+20°C:		-40°C:
untreated	600	800	27	80		55
<b>Operating data</b>						
		Polarity = +	shielding gas: Ar + 15 – 25% CO2 offers the best weldability, but 100% CO2 can also be used (voltage should be increased by 2V). Gas flow rate 20 – 25 l/min.			
<b>Dimensions (mm)</b>		<b>Amperage A</b>				
1,2		125-240				

<b>Classifications</b>	high-alloyed rutile	
EN ISO 17633-A:	AWS A5.22:	
T 22 9 3 N L P M21 1 ; T 22 9 3 N L P C1 1	E2209T1-4 ; E2209T1-1	

**Characteristics and field of use**

BÖHLER CN 22/9 PW-FD is a strip alloyed, duplex steel rutile flux cored wire for position welding of duplex steels in the chemical apparatus, plant and container construction, for chemical tankers and in the offshore industry. The support provided by the fast-hardening slag allows out-of-position welding with high current magnitudes and high welding speeds. The advantage of the slag is its supporting effect on the weld pool. This permits, for example, welding with the stringer bead technique at a correspondingly high welding speed even in difficult pipe welding positions (5G, 6G). The fine droplet, low-spatter, very powerfully welding spray arc, the reliable fusion penetration, the self-releasing slag and the effectively wetting seam formation result in a high weld quality at the same time as short welding times. The structure of the weld metal consists of austenite and ferrite (FN 30-50). The pitting resistance equivalent is  $PREN \geq 35$  (%Cr+3.3%Mo+16%N). Testing the weld metal in accordance with ASTM G48 Method A resulted in a CPT (critical pitting temperature) of 25°C. Also suited to joining different materials and to weld cladding. Usable between -46°C and +250°C.

**Base materials**

Same-type duplex steels and similar-alloy, ferritic-austenitic materials of increased strength, as well as for dissimilar joints between duplex steels and unalloyed or low-alloy, creep resistant and austenitic steels. 1.4462 X2CrNiMoN22-5-3, 1.4362 X2CrNiN23-4, 1.4462 X2CrNiMoN22-5-3 with 1.4583 X10CrNiMoNb18-12, 1.4462 X2CrNiMoN22-5-3 with P235GH/ P265GH, S255N, P295GH, S460N, 16Mo3, UNS S31803, S32205

**Typical composition of all-weld metal (Wt-%)**

C	Si	Mn	Cr	Ni	Mo	N	PRE <sub>N</sub>	FN
≤ 0,03	0,8	0,9	22,7	9,0	3,2	0,13	≥35	30-50

**Mechanical properties of all-weld metal**

Heat Treatment	Yield strength 0,2%	Tensile strength	Elongation (L <sub>0</sub> =5d <sub>0</sub> )	Impact values in J CVN			
	MPa	MPa	%	+20°C:	-20°C:	-40°C:	-46°C:
untreated	600	800	27	80	65	55	45

**Welding position**

	Polarity = +	re-drying: - in exceptional cases: 150 C/24 h shielding gases: M1 – M3; C1 Welding with conventional MAG devices, slightly trailing torch position (angle of incidence about 80°); slight weaving of the torch is recommended in all positions; with 100% CO <sub>2</sub> the voltage must be 2 V higher. The gas quantity should be 15-18l/min.
---	--------------	--

Dimensions(mm)	Amperage A
1,2	100-220

**Approvals and Certificates**

TÜV-D (07666.), ABS (E 22 09 T1-4(1)), CWB (E2209T1-1(4)), DNV (X (M21;C1)), GL (4462S (M21)), LR (X (M21,C1)), RINA (2209 S), SEPROZ, CE

A		FC - L X 0				Flux cored wire	
<b>Classifications</b>		high-alloyed rutile					
EN ISO 17633-A:							
T 23 7 N L R M/C 3							
<b>Characteristics and field of use</b>							
<p>Avesta FCW-2D LDX 2101 is designed for welding the duplex stainless steel Outokumpu LDX 2101. The steel is a lean duplex steel with excellent strength and medium corrosion resistance. LDX 2101 is mainly intended for applications such as civil engineering, storage tanks, containers etc. Avesta FCW-2D LDX 2101 provides excellent weldability in flat as well as horizontal/vertical position. Welding in vertical-up and overhead positions is preferably done using FCW LDX 2101-PW. Avesta FCW-2D LDX 2101 should be welded using direct current positive polarity (DC+) with a recommended wire stick-out of 15 – 20mm. The weldability of duplex steels is excellent, but the welding should be adapted to the base material, considering fluidity, joint design, heat input etc.</p> <p><b>Corrosion resistance:</b>            Good resistance to general corrosion. Better resistance to pitting, crevice corrosion and stress corrosion cracking than 1.4301/AISI 304.</p>							
<b>Base materials</b>							
For welding steels such as							
Outokumpu	EN	ASTM	BS	NF	SS		
LDX 2101	1.4162	S32101	-	-	-		
<b>Typical analysis of all-weld metal (Wt-%)</b>							
C	Si	Mn	Cr	Ni	Mo	N	
0,025	0,7	1,1	24,0	9,0	0,5	0,14	
Ferrite 35 FN; WRC-92							
<b>Mechanical properties of all-weld metal</b>							
Heat Treatment	Yield strength 0,2%	Tensile strength	Elongation ( $L_0=5d_0$ )	Impact values in J CVN			
	MPa	MPa	%	+20°C:		-40°C:	
untreated	550	740	31	65		45	
<b>Operating data</b>							
	Polarity = +		shielding gas: Ar + 15 – 25% CO2 offers the best weldability, but 100% CO2 can also be used (voltage should be increased by 2V). Gas flow rate 20 – 25 l/min.				
<b>Dimensions (mm)</b>		<b>Amperage A</b>					
1,2		125-280					

A FC L X 0 -P

Flux cored wire

**Classifications**

high-alloyed rutile

EN ISO 17633:

T 23 7 N L P M/C1

**Characteristics and field of use**

Avesta FCW LDX 2101-PW is designed for welding the duplex stainless steel Outokumpu LDX 2101. The steel is a lean duplex steel with excellent strength and medium corrosion resistance. LDX 2101 is mainly intended for applications such as civil engineering, storage tanks, containers etc. Avesta FCW LDX 2101-PW has a stronger arc and a faster freezing slag compared to the 2D type. It is designed for all-round welding and can be used in all positions without changing the parameter settings. Weldability is excellent in the vertical-up and overhead welding positions. Avesta FCW LDX 2101-PW should be welded using direct current positive polarity (DC+) with a recommended wire stick-out of 15 – 20 mm. The weldability of duplex steels is excellent, but the welding should be adapted to the base material, considering fluidity, joint design, heat input etc.

**Corrosion resistance:**

Good resistance to general corrosion. Better resistance to pitting, crevice corrosion and stress corrosion cracking than 1.4301/AISI 304.

**Base materials**

For welding steels such as					
Outokumpu	EN	ASTM	BS	NF	SS
LDX 2101	1.4162	S32101	-	-	-

**Typical analysis of all-weld metal (Wt-%)**

C	Si	Mn	Cr	Ni	Mo	N
0, 025	0,7	0,9	24,3	9,0	0,3	0,13

Ferrite 30 FN; WRC-92

**Mechanical properties of all-weld metal**

Heat Treatment	Yield strength 0,2%	Tensile strength	Elongation ( $L_0=5d_0$ )	Impact values in J CVN	
	MPa	MPa	%	+20°C:	-40°C:
untreated	575	765	30	70	50

**Operating data**

	Polarity = +	shielding gas: Ar + 15 – 25% CO <sub>2</sub> offers the best weldability, but 100% CO <sub>2</sub> can also be used (voltage should be increased by 2V), as flow rate 20 – 25 l/min.
---	--------------	---

Dimensions (mm)	Amperage A
1,2	150-240

A FC 507 P 00-P			Flux cored wire			
<b>Classifications</b>		high-alloyed rutile				
EN ISO 17633-A:		AWS A5.22:				
T 25 9 4 N L P M21 1		E2594T1-4				
<b>Characteristics and field of use</b>						
<p>Avesta FCW 2507/P100-PW is designed for welding super duplex steels like 2507/1.4410 and similar grades for use down to <math>-50^{\circ}\text{C}</math>. Super duplex steels are particularly popular for desalination, pulp &amp; paper, flue gas cleaning and sea water system applications. Avesta FCW 2507/P100-PW is designed for all-round welding and can be used in all positions without changing the parameter settings. Weldability is excellent in the vertical up and overhead welding positions. Avesta FCW 2507/P100-PW should be welded using direct current positive polarity (DC+) with a recommended wire stick-out of 15 – 20 mm. The weldability of duplex and super duplex steels is excellent, but the welding should be adapted to the base material, considering fluidity, joint design, heat input etc.</p> <p><b>Corrosion resistance:</b> Very good resistance to pitting and stress corrosion cracking in chloride containing environments. PREN &gt;41. Meets the corrosion test requirements per ASTM G48 Methods A, B and E (<math>40^{\circ}\text{C}</math>).</p>						
<b>Base materials</b>						
For welding steels such as						
Outokumpu	EN	ASTM	BS	NF	SS	
2507	1.4410	S32750	-	Z3 CND 25-06 Az	2328	
4501	1.4501	S32760	-	-	-	
<b>Typical composition of all-weld metal (Wt-%)</b>						
C	Si	Mn	Cr	Ni	Mo	N
0,03	0,7	0,9	24,7	9,8	3,7	0,23
Ferrite 40 FN WRC-92						
<b>Mechanical properties of all-weld metal</b>						
Heat Treatment	Yield strength 0,2%	Tensile strength	Elongation ( $L_0=5d_0$ )	Impact values in J CVN		
	MPa	MPa	%	+20°C:	-40°C:	
untreated	670	890	26	50	32	
<b>Operating data</b>						
		Polarity = +	shielding gas: Ar + 15 – 25% CO2 offers the best weldability, but 100% CO2 can also be used (voltage should be increased by 2V). Gas flow rate 20 – 25 l/min.			
<b>Dimensions (mm)</b>		<b>Amperage A</b>				
1,2		150-240				

<b>Classifications</b>	high-alloyed rutile	
EN ISO 17633-A:	AWS A5.22:	
T 18 8 Mn R M21 3 ; T 18 8 Mn R C1 31	E307T0-G (mod.)	

### Characteristics and field of use

Rutile flux cored wire predominantly for flat and horizontal welding positions. The easy handling and high deposition rate of Böhler A7-FD result in high productivity with excellent welding performance, self-releasing slag, very low spatter formation and seam oxidation, finely rippled weld seams with good wetting behaviour and even, reliable fusion penetration. Properties of the weld metal: suitable for strain-hardening, very good cavitation resistance, crack resistant, resistant to thermal shock, resistant to scaling up to 850°C, no tendency to sigma-phase embrittlement above 500°C, cryogenic down to -60°C. Consultation with the manufacturer is recommended for operating temperatures above 650 C.

### Base materials

high-strength, unalloyed and alloyed structural, quenched and tempered and armour steels among themselves or among each other; unalloyed and alloyed boiler or structural steels with high-alloy Cr and Cr-Ni steels; heat-resistant steels up to +850 C; austenitic manganese steels together and with other steels; cryogenic plate and pipe steels together with cryogenic austenitic materials.

### Typical composition of all-weld metal (Wt-%)

C	Si	Mn	Cr	Ni
0,1	0,7	6,5	18,5	8,8

### Mechanical properties of all-weld metal

Heat Treatment	Yield strength 0,2%	Tensile strength	Elongation ( $L_0=5d_0$ )	Impact values in J CVN	
	MPa	MPa	%	+20°C:	
untreated	420	630	39	60	

### Welding position

	Polarity = +	re-drying: - in exceptional cases: 150 C/24 h shielding gases: Argon + 15-25% CO2 100% CO2 The gas quantity should be 15-18 l/min. Slightly trailing torch position (angle of incidence about 80°). It is recommended that the voltage is increased by 2 V if the shielding gas is 100% CO2. Preheating and interpass temperature as required by the base metal.
---	--------------	--

Dimensions(mm)	Amperage A
1,2	125-280
1,6	200-350

### Approvals and Certificates

TÜV-D (11101.), CE



# BÖHLER A 7-MC

Metal cored wire

I cored wire

## Classifications

high-alloyed rutile

EN ISO 17633-A:

AWS A5.22

T 18 8 Mn M M12 1

EC307 (mod.)

## Characteristics and field of use

The metal cored wire is characterised by easy handling, high deposition rate, exceptional welding performance, very low spatter formation, finely rippled weld seams, good wetting behaviour and even, reliable fusion penetration. The arc, which is wider than that of solid wire, significantly reduces the risk of lack of fusion, and ensures good gap bridging. Properties of the weld metal: suitable for strain-hardening, very good cavitation resistance, crack resistant, resistant to thermal shock, resistant to scaling up to +850°C, no tendency to sigma-phase embrittlement above +500°C, heat treatment can be carried out without difficulty, cryogenic down to -110°C. Consultation with the manufacturer is recommended for operating temperatures above +650°C.

## Base materials

For production, repair and maintenance welding. high-strength, unalloyed and alloyed structural, quenched and tempered and armour steels among themselves or among each other; unalloyed and alloyed boiler or structural steels with high-alloy Cr and Cr-Ni steels; heat-resistant steels up to +850 °C; austenitic manganese steels together and with other steels; cryogenic plate and pipe steels together with cryogenic austenitic materials.

## Typical composition of all-weld metal (Wt-%)

C	Si	Mn	Cr	Ni
0,1	0,6	6,3	18,8	9,2

## Mechanical properties of all-weld metal

Heat Treatment	Yield strength 0,2%	Tensile strength	Elongation ( $L_0=5d_0$ )	Impact values in J CVN	
	MPa	MPa	%	+20°C:	
untreated	400	600	42	70	

## Welding position

	Polarity = +	re-drying: - in exceptional cases: 150 C/24 h shielding gases: Argon + 2.5% CO2 The gas quantity should be 15-18 l/min. Preheating and interpass temperature as required by the base metal. A leading torch position is preferable (angle of incidence about 80°). Recommended free wire length 15-20 mm and arc length 3-5 mm. The Pulsarc technique is to be recommended for position welding, as it is with the solid wires.
---	--------------	--

## Dimensions(mm)

## Amperage A

1,2

60-280

1,6

100-370

## Approvals and certificates

TÜV-D (10871.), DB (43.014.27), CE

A FC - P5 Flux cored wire

<b>Classifications</b>	high-alloyed rutile	
EN ISO 17633-A:	AWS A5.22:	
T 23 12 2 L R M/C 3	E309LMoT0-4 ; E309LMoT0-1	

Characteristics and field of use

Avesta FCW-2D P5 is a molybdenum alloyed wire of the 309MoL type, primarily designed for welding dissimilar joints between stainless steels and low-alloy steels. It is also widely used for surfacing low-alloy steels offering a composition similar to that of ASTM 316 from the first run. Avesta FCW-2D P5 provides excellent weldability in flat as well as horizontal/vertical position. Welding in vertical-up and overhead positions is preferably done using FCW P5-PW. Avesta FCW-2D P5 should be welded using direct current positive polarity (DC+) with a recommended wire stick-out of 15 – 20 mm.

**Corrosion resistance:**  
Superior to type 316L fillers. When used for overlay welding on mild steel a corrosion resistance equivalent to that of 1.4401/316 is obtained already in the first layer.

Base materials

For welding steels such as					
Outokumpu	EN	ASTM	BS	NF	SS
Avesta P5 is primarily used when surfacing unalloyed or low-alloy steels and when joining molybdenum-alloyed stainless and carbon steels.					

Typical composition of all-weld metal (Wt-%)

C	Si	Mn	Cr	Ni	Mo
0,025	0,7	1,4	22,9	12,6	2,7

Ferrite 25 FN; WRC-92

Mechanical properties of all-weld metal

Heat Treatment	Yield strength	Tensile strength	Elongation (L <sub>0</sub> =5d <sub>0</sub> )	Impact values in J CVN
	0,2%			
	MPa	MPa	%	+20°C:
untreated	500	700	30	55

Operating data

	Polarity = +	shielding gas: Ar + 15 – 25% CO <sub>2</sub> Ar + 15 – 25% CO <sub>2</sub> offers the best weldability, but 100% CO <sub>2</sub> can also be used (voltage should be increased by 2V). Gas flow rate 20 – 25 l/min.

Dimensions (mm)	Amperage A
1,2	125-280
1,6	200-350



# BÖHLER CN 23/12 Mo-FD

Flux cored wire

## Classifications

high-alloyed rutile

EN ISO 17633-A:

AWS A5.22:

T 23 12 2 L R M21 (C1) 3

E309LMoT0-4 ; 309LMoT0-1

## Characteristics and field of use

Rutile, strip alloyed, flux cored wire for welding austenite-ferrite joints and for weld claddings primarily in the flat and horizontal welding positions. The flux cored wire is characterised by particularly good resistance to hot cracking even when subject to high dilution, and is necessary for the first layer of Mo-alloyed eld claddings. The easy handling and high deposition rate result in high productivity with excellent welding behaviour, self-releasing slag, low spatter formation and seam oxidation, finely rippled weld seams with good wetting behaviour and even, reliable fusion penetration. The weld metal is suitable for an operating temperature range between -60°C and +300°C. BÖHLER CN 23/12 Mo-FD Ø0.9 mm is particularly suitable for joint welding of thin sheet (approx. 1.5 mm, in position from 5.0 mm). The nature of the slag has been designed so that this dimension can be used in all positions. The Ø1.2 mm electrode can be used for welding with wall thicknesses from about 3 mm.

## Base materials

high-strength, unalloyed and alloyed structural and quenched and tempered steels among themselves or among each other, unalloyed and alloyed boiler or structural steels with high-alloy Cr, CrNi and CrNiMo steels. Austenite-ferrite joints for boiler and pressure vessel construction. Particularly suitable for the first layer of corrosion-resistant Mo-alloyed weld claddings on P235G1TH, P255G1TH, S255N, P295GH, S355N - S500N and on creep resistant, quenched and tempered fine-grained structural steels according to AD HP 0, test group 3

## Typical composition of all-weld metal (Wt-%)

C	Si	Mn	Cr	Ni	Mo
0,03	0,6	1,4	23,0	12,5	2,7

## Mechanical properties of all-weld metal

Heat Treatment	Yield strength	Tensile strength	Elongation	Impact values	
	0,2%		(L <sub>0</sub> =5d <sub>0</sub> )	in J CVN	
	MPa	MPa	%	+20°C:	-60°C:
untreated	500	700	30	55	37

## Welding position



Polarity = +

re-drying: - in exceptional cases: 150 C/24 h  
shielding gases: Argon + 15-25% CO2  
100% CO2

The gas quantity should be 15-18 l/min. Slightly trailing torch position (angle of incidence about 80°). It is recommended that the voltage is increased by 2 V if the shielding gas is 100% CO2 Preheating and interpass temperature as required by the base metal.

## Dimensions(mm)

## Amperage A

0,9	120-160
1,2	125-280
1,6	200-350

## Approvals and Certificates

TÜV-D (5351.), DB (43.014.17), ABS (E 308 MoLT0-4), DNV (309MoL (M21)), GL (4459 (C1, M21)), LR (X (M21)), RINA (309MO S), SEPROZ, CE, CWB (E309LMoT0-1 (4))

**BÖHLER CN 23/12 Mo PW-FD**

Flux cored wire

**Classifications**

high-alloyed rutile

EN ISO 17633-A:

AWS A5.22

T 23 12 2 L P M21 1 ; T 23 12 2 L P C1 1

E309LMoT1-4 ; E309LMoT1-1

**Characteristics and field of use**

Rutile, strip alloyed, flux cored wire for position welding of austenite-ferrite joints, and for the first layer of weld claddings of unalloyed and low-alloy Base materials. The flux cored wire is characterised by particularly good resistance to hot cracking even when subject to high dilution, and is necessary for the first layer of Mo-alloyed weld claddings. The support provided by the fast-hardening slag allows out-of-position welding with high current magnitudes and high welding speeds. The fine droplet, low-spatter, very intense spray arc, the reliable fusion penetration, the self-releasing slag and the good wetting behaviour result in a high weld quality at the same time as short welding times. Additional advantages to its application are the ease of handling, the low heat input resulting from the high welding speed, and the small amounts of cleaning and pickling required. The weld metal is suitable for an operating temperature range between -60°C and +300°C. BÖHLER CN 23/12 Mo-FD is preferred for flat and horizontal welding positions (PA, PB).

**Base materials**

high-strength, unalloyed and alloyed structural and quenched and tempered steels among themselves or among each other, unalloyed and alloyed boiler or structural steels with high-alloy Cr, CrNi and CrNiMo steels. Austenite-ferrite joints for boiler and pressure vessel construction. Particularly suitable for the first layer of corrosion-resistant Mo-alloyed weld claddings on P235G1TH, P255G1TH, S255N, P295GH, S355N - S500N and on creep resistant, quenched and tempered fine-grained structural steels according to AD HP 0, test group 3

**Typical composition of all-weld metal (Wt-%)**

C	Si	Mn	Cr	Ni	Mo
0,03	0,7	1,4	23,0	2,7	12,5

**Mechanical properties of all-weld metal**

Heat Treatment	Yield strength 0,2%	Tensile strength	Elongation ( $L_0=5d_0$ )	Impact values in J CVN	
				+20°C:	-60°C:
untreated	530	720	32	65	50

**Welding position**

	Polarity = +	re-drying: - in exceptional cases: 150 C/24 h shielding gases: Argon + 15-25% CO <sub>2</sub> The gas quantity should be 15-18 l/min. Slightly trailing torch position (angle of incidence about 80°), slight weaving of the torch is recommended in all positions. It is recommended that the voltage is increased by 2 V if the shielding gas is 100% CO <sub>2</sub> . Preheating and interpass temperature as required by the base metal.
---	--------------	--

**Dimensions(mm)**

1,2

**Amperage A**

100-220

**Approvals and certificates**

TÜV-D (09116.), BV (309 Mo), LR (SS/CMn), SEPROZ, CE, DNV (309 MoL)

BÖHLER CN 4-MC		Metal cored wire			
<b>Classifications</b>		high-alloyed rutile			
EN ISO 17633-A:	AWS A5.9:				
T 13 4 M M12 2	EC410NiMo (mod.)				
<b>Characteristics and field of use</b>					
Metal cored wire for same-type corrosion-resistant, soft martensitic and martensitic-ferritic rolled, forged and cast steels. Used for water turbine and compressor fabrication. The easy handling and high deposition rate of BÖHLER CN 13/4-MC result in high productivity with excellent welding performance, very low spatter formation, finely rippled weld pattern with good wetting behaviour and even, reliable fusion penetration. BÖHLER CN 13/4-MC features very good toughness properties for the heat-treated weld metal, along with very low hydrogen content in the weld metal (under AWS conditions HD max. 4 ml/100 g) and optimum feeding characteristics.					
<b>Base materials</b>					
1.4317 GX4CrNi13-4, 1.4313 X3CrNiMo13-4, 1.4407 GX5CrNiMo13-4, 1.4414 GX4CrNiMo13-4 ACI Grade CA 6 NM					
<b>Typical composition of all-weld metal (Wt-%)</b>					
C	Si	Mn	Cr	Ni	Mo
≤0.025	0,7	0,9	12,0	4,6	0,6
<b>Mechanical properties of all-weld metal</b>					
Heat Treatment	Yield strength 0,2%	Tensile strength	Elongation ( $L_0=5d_0$ )	Impact values in J CVN	
	MPa	MPa	%	+20°C:	-20°C:
untreated	760	900	16	65	60
<b>Welding position</b>					
	Polarity = +	re-drying: - shielding gas: M1 Welding with conventional MAG devices or with a Pulsarc, slightly trailing torch position (angle of incidence about 80°). Recommended free wire length about 18-20 mm. Arc length ~ 3 mm. Preheating and interpass temperature of thick-walled components 100-160°C. Heat input max. 15 kJ/cm. Tempering at +580-620 C.			
<b>Dimensions(mm)</b>			<b>Amperage A</b>		
1,2			130-370		
1,6			250-550		
<b>Approvals and certificates</b>					
SEPROZ					

A FC P -P Flux cored wire

<b>Classifications</b>	nickel-based	
EN ISO 12153:	AWS A5.34:	
T Ni 6625 P M 2	ENiCrMo3T1-4	

Characteristics and field of use

Avesta FCW P12-PW is a nickel base wire primarily intended for welding the nickel base alloys type 625 and 825 and 6 Mo steels such as Outokumpu 254 SMO. It can also be used for welding 9 Ni steels for use in cryogenic applications. Avesta FCW P12-PW is designed for allround welding and can be used in all positions without changing the parameter settings. Weldability is excellent in the verticalup and overhead welding positions. To minimise the risk of hot cracking when welding fully austenitic steels and nickel base alloys, heat input and interpass temperature must be low and there must be as little dilution as possible from the parent metal. Avesta FCWP12-PW should be welded using direct current positive polarity (DC+) with a recommended wire stick-out of 15 – 20 mm.

**Corrosion resistance:**

Excellent resistance to general corrosion in various types of acids and to pitting, crevice corrosion and stress corrosion cracking in chloride containing environments. Meets the corrosion test requirements per ASTM G48 Methods A, B and E (50°C).

Base materials

For welding steels such as					
Outokumpu	EN	ASTM	BS	NF	SS
254 SMO	1.4547	S31254	-	-	2378
Also for welding nickel base alloys to stainless or unalloyed steels and for surfacing.					

Typical composition of all-weld metal (Wt-%)

C	Si	Mn	Cr	Ni	Mo	Nb	Fe
0,02	0,4	0,1	20,5	bal.	8,7	3,3	<1,0

Ferrite 0 FN

Mechanical properties of all-weld metal

Heat Treatment	Yield strength 0,2%	Tensile strength	Elongation ( $L_0=5d_0$ )	Impact values in J CVN		
	MPa	MPa	%	+20°C:	-40°C:	-196°C:
untreated	460	750	40	75	60	45

Operating data

	Polarity = +	shielding gas: Ar + 15 – 25%CO2 Gasflow rate 20 – 25 l/min.
---	--------------	--

Dimensions (mm)	Amperage A
1,2	150-240

## Classifications

nickel-based

EN ISO 12153:

AWS A5.34:

T Ni 6625 P M21 2

ENiCrMo3T1-4

## Characteristics and field of use

Flux cored wire containing rutile for high quality welded joints to nickel-based alloys with a high Mo content (e.g. Alloy 625 and Alloy 825) and also to CrNiMo steels with a high Mo content (e.g. 6 Mo steels). This type is also suitable for creep resistant and highly creep resistant steels, heat resistant and cryogenic materials, dissimilar joints and low-alloy, hard-to-weld steels. Suitable for pressure vessel construction for -196°C to +550°C, otherwise with scaling resistance up to +1200°C (sulphur-free atmosphere). Because of the embrittlement of the base material between 600 and 850°C, use in this temperature range should be avoided. High resistance to hot cracking, in addition to which the C-diffusion at high temperatures or during heat treatment of dissimilar joints is largely inhibited. Extremely high resistance to stress corrosion cracking and pitting (PREN 52). Resistant to thermal shock, stainless, fully austenitic. Low expansion coefficient between C-steel and austenitic CrNi(Mo) steel. Can be welded out-of-position.

## Base materials

2.4856 NiCr22Mo9Nb, 2.4858 NiCr21Mo, 2.4816 NiCr15Fe, 1.4583 X10CrNiMoNb18-12, 1.4876 X10NiCrAlTi32-21, 1.4529 X1NiCrMoCuN25-20-7, X2CrNiMoCuN20-18-6, 2.4641 NiCr21Mo6Cu, Joints of the above-mentioned materials with unalloyed and low-alloy steels such as P265GH, P285NH, P295GH, 16Mo3, S355N, X8Ni9, N 08926, ASTM A 553 Gr.1, Alloy 600, Alloy 625, Alloy 800, 9% Ni steels

## Typical composition of all-weld metal (Wt-%)

C	Si	Mn	Cr	Mo	Ni	Nb	Fe
≤0.05	0,4	0,4	21,0	8,5	bal.	3,3	<1,0

## Mechanical properties of all-weld metal

Heat Treatment	Yield strength 0,2%	Tensile strength	Elongation ( $L_0=5d_0$ )	Impact values in J CVN	
	MPa	MPa	%	+20°C:	-196°C:
untreated	500	740	40	90	80

## Welding position

	Polarity = +	shielding gases: Argon + 15-25% CO2 Welding with conventional MAG devices, slightly trailing torch position (angle of incidence about 80°). The gas quantity should be 15-18 l/min.
---	--------------	---

## Dimensions(mm)

## Amperage A

1,2

150-250

## Approvals and certificates

TÜV-D (11223.), CE

# UTP AF 6222 MoPW

Flux cored wire

Classifications		nickel-based
EN ISO 14172:	AWS A5.34:	
E Ni 6625 (NiCr22Mo9Nb)	ENiCrMo3 T1-4	

## Characteristics and field of use

UTP AF 6222 MoPW tubular wire nickel alloy is applicable for bonding weld and coating weld in nickel-based materials and on materials from similar nature and on CrNi stainless steels and low alloy steels. It is also used for high temperature applications

### Welding Characteristics:

UTP AF 6222 MoPW tubular wire nickel alloy exhibits excellent behavior in welds out position and high welding speed. This wire has a stable metal transfer through small droplets. The wide range of operational parameters enables its use for diverse thicknesses of base material.

### Welding Instructions:

Clean the surface to be welded (shiny metal). Keep welding power and temperature low and maximum interpass temperature at 150 °C.

## Base materials

DIN Nomenclature	Material No.	UNS No.	Alloy type
NiCr22Mo9Nb	2.4856	N 06625	625
X NiCrMoCu25 20 5	1.4539	N 08904	904
X NiCrNb 18 12	1.4583		
SIE 355	1.0562		
X 8Ni9	1.5662		A 553 Tp.1

## Typical composition of all-weld metal (Wt-%)

C	Si	Mn	Cr	Mo	Nb	Fe	P	S	Ni
≤0.03	0,4	0,4	21,5	9,0	3,5	0,5	0,01	0,01	bal.

## Mechanical properties of all-weld metal

Heat Treatment	Yield strength	Tensile strength	Elongation	Impact values in J CVN
	0,2%		( $L_0=5d_0$ )	
	MPa	MPa	%	-196 °C:
untreated	490	750	30	60

## Welding position

	Polarity = +	shielding gases: Argon + 15 – 25% CO2
---	--------------	--

Dimensions(mm)	Amperage A
1,2	160-260

## Approvals and certificates

TÜV (Nr. 10991)



<b>Classifications</b>		nickel-based
EN ISO 12153:	AWS A5.34:	
T Ni 6082 R M21 3	ENiCr3T0-4	

**Characteristics and field of use**

Flux cored wire containing rutile with basic components primarily for flat and horizontal welding positions. The easy handling and high deposition rate of BÖHLER NIBAS 70/20-FD result in high productivity with excellent welding performance, self-releasing slag, very low spatter formation and seam oxidation, finely rippled weld pattern with good wetting behaviour and even, reliable fusion penetration. In addition to the significant savings in time and costs of processing techniques and to the lower requirement for cleaning and pickling, BÖHLER NIBAS 70/20-FD ensures a high level of quality and highly reliable avoidance of welding defects. Suitable for high-quality welded joints to nickel-based alloys, creep resistant and highly creep resistant materials, heat resistant and cryogenic materials, and also for low-alloy, hard-to-weld steels and dissimilar joints. Also for ferrite-austenite joints at operating temperatures  $\geq 300^{\circ}\text{C}$  or with subsequent heat treatments. Suitable for pressure vessel construction for  $-196^{\circ}\text{C}$  to  $+550^{\circ}\text{C}$ , otherwise with scaling resistance up to  $+1200^{\circ}\text{C}$  (sulphur-free atmosphere). No tendency to embrittlement, while C-diffusion at high temperatures is largely inhibited. Resistant to thermal shock, stainless, fully austenitic, low coefficient of expansion.

**Base materials**

2.4816 NiCr15Fe, 2.4817 LC-NiCr15Fe, Alloy 600, Alloy 600 L Nickel and nickel alloys, low-temperature steels up to X8Ni9, high-alloy Cr and Cr-Ni-Mo steels, particularly for dissimilar joints, and their joints to unalloyed, low-alloy, creep resistant and highly creep resistant steels. Also suitable for the Alloy 800 (H) material.

**Typical composition of all-weld metal (Wt-%)**

C	Si	Mn	Cr	Ni	Nb	Fe
$\leq 0.03$	0,4	3,2	19,5	bal.	2,5	$\leq 2.0$

**Mechanical properties of all-weld metal**

Heat Treatment	Yield strength 0,2%	Tensile strength	Elongation ( $L_0=5d_0$ )	Impact values in J CVN	
	MPa	MPa	%	+20°C:	-196°C:
untreated	400	650	39	135	110

**Welding position**

	Polarity = +	re-drying if necessary: – shielding gas: Argon + 15-25% CO2 Welding with conventional MAG devices, slightly trailing torch position (angle of incidence about $80^{\circ}$ ); avoid overheating, only slight torch weaving. The gas quantity should be 15-20 l/min.
---	--------------	--

Dimensions(mm)	Amperage A
1,2	130-260
1,6	150-350

**Approvals and certificates**

TÜV-D (10298.), CE

Classifications		nickel-based
EN ISO 12153:	AWS A5.34:	
E Ni 6082 (NiCr20Mn3Nb)	E NiCr 3 T0-4	

## Characteristics and field of use

UTP AF 068 HH is a Ni-base flux cored wire (NiCr) for joining and surfacing of nickel alloys of the same or of similar nature, heterogeneous joints with C- and CrNi-steels, claddings on C-steels. Typical applications are high-temperature components.

**Welding characteristics and special properties of the weld metal:**

UTP AF 068 HH is characterised by its hot cracking resistance and tough weld metal and is used for service temperatures up to 900° C in long-term period. UTP AF 068 HH has outstanding welding characteristics with a regular and fine drop transfer. The seam is finely rippled and the transition from the weld to the base metal is regular and free from notches. The wide adjustment range of welding parameters enables an application on different wall thicknesses.

## Base materials

DIN Nomenclature	Material No.	UNS No.	Alloy type
NiCr15Fe	2.4816	N06600	600
LC NiCr15Fe	2.4817	N01665	600 LC
X10CrNiMoNb18 12	1.4583*		
X10NiCrAlTi 32 21	1.4876		800
GX10NiCrNb32 20	1.4859		
StE 355	1.0562*		

\*Dissimilar joints with nickel-alloys

## Typical composition of all-weld metal (Wt-%)

C	Si	Mn	P	S	Cr	Ni	Nb	Fe
≤0.03	0,4	3,0	0,007	0,005	20,0	bal.	2,4	1,4

## Mechanical properties of all-weld metal

Heat Treatment	Yield strength	Tensile strength	Elongation	Impact values
	0,2%		( $L_0=5d_0$ )	
	MPa	MPa	%	at RT
untreated	400	650	39	135

## Welding position

	Polarity = +	shielding gases: Argon + 15 – 25% CO2
---	--------------	--

## Dimensions(mm)

1,2

## Approvals and certificates

TÜV (No. 10209)



## Chapter 6.1 Finishing Chemicals

Product name	Page
Avesta PICKLING GEL 122	2
Avesta BLUEONE PICKLING PASTE 130	3
Avesta REDONE PICKLING PASTE 140	4
Avesta PICKLING SPRA 204	5
Avesta REDONE PICKLING SPRA 240	6
Avesta PICKLING BATH 302	7
Avesta CLEANER 401	8
Avesta PASSIVATOR 601	9
Avesta FINISHONE PASSIVATOR 630	10

#### Pickling gel for use and storage in warmer climates

Avesta Pickling Gel 122 is more free-flowing than a pickling paste to facilitate the application and to give a high coverage. It can hence be used to clean with a good result.

#### Standard applications

This gel is universal and specifically intended for standard brush pickling of weld seams and smaller surfaces of all stainless steel grades.

#### Characteristics

Restores damaged stainless steel surfaces, such as weld seams, by removing weld oxides, the underlying chromiumdepleted layer and other defects that may cause local corrosion. Improved pickling result, offers a brighter surface with less discolouration than classical products.  
The transparent gel consistency gives good adhesion to the stainless steel surface.  
Can be used and stored in warmer climates (the gel is heatstable up to +45 °C).

**[www.avestafinishing.com](http://www.avestafinishing.com)  
where you can find Safety Data Sheets and other useful information.**

A unique patented, safer-to-use pickling paste!

Many of the processes used for pickling stainless steel lead to the development of hazardous nitric fumes. To improve safety when pickling, Avesta Finishing Chemicals has developed a unique patented low-fuming pickling paste which reduces toxic nitric fumes by 80 %.

#### Standard applications

Avesta BlueOne Pickling Paste 130 is universal, suitable for brush pickling of welds and smaller surfaces of all stainless steel grades.

#### Characteristics

Restores damaged stainless steel surfaces, such as weld seams, by removing weld oxides, the underlying chromiumdepleted layer and other defects that may cause local corrosion. Improved pickling result, offers a brighter surface with less discolouration than classical products.

Unique and covered by a world patent.

Higher yield, decreased consumption, thanks to the visible blue colour and its free-flowing consistency which facilitates application. The paste is easy to apply and highly visible.

**[www.avestafinishing.com](http://www.avestafinishing.com)  
where you can find Safety Data Sheets and other useful information.**

A powerful, low-fuming, safer-to-use pickling paste!

Many of the processes used for pickling stainless steel lead to the development of hazardous nitric fumes. To improve safety when pickling, Avesta Finishing Chemicals has developed a unique patented low-fuming pickling paste which reduces toxic nitric fumes by 50 %.

#### Standard applications

Avesta RedOne Pickling Paste 140 is intended for powerful brush pickling of welds and smaller surfaces of high-alloy steel grades in tough applications. For non-heavy-duty applications we suggest our low fuming Avesta BlueOne Pickling Paste 130 in order to improve the environmental impact and safety when pickling.

#### Characteristics

Restores damaged stainless steel surfaces, such as weld seams, by removing weld oxides, the underlying chromium-depleted layer and other defects that may cause local corrosion. Unique and patented.

Higher yield, decreased consumption, thanks to the visible red colour and its free-flowing consistency which facilitates application. The paste is easy to apply and highly visible.

**[www.avestafinishing.com](http://www.avestafinishing.com)**  
**where you can find Safety Data Sheets and other useful information.**

A powerful pickling spray for heavy-duty applications

Avesta Pickling Spray 204, is intended for heavy-duty applications and offers an aggressive spray pickling result for larger stainless steel surfaces.

Standard applications

Avesta Pickling Spray 204 is intended for tougher applications such as heavy hot rolled plates, high-alloyed steels such as 904, duplex and SMO, thicker weld oxides and pickling at lower temperatures. For non-heavy-duty applications we suggest the use of our low-fuming Avesta RedOne Pickling

Characteristics

Restores stainless steel surfaces that have been damaged during fabrication operations such as welding, forming, cutting and blasting. It removes weld oxides, the underlying chromium-depleted layer and other defects that may cause local corrosion.

Has a thixotropic consistency, which makes it stick well to the surface and hence facilitates the application even in difficult positions.

The process is sensitive to strong sunlight/high temperatures and the spray may dry into the surface and be difficult to remove.

Passivation

To further improve the result we recommend passivating after pickling using Avesta FinishOne Passivator 630, which is a safer acid-free passivation method.

**[www.avestafinishing.com](http://www.avestafinishing.com)**  
where you can find **Safety Data Sheets** and other useful information.



A unique, safer-to-use pickling spray!

Many of the processes used for pickling stainless steel lead to the development of hazardous nitric fumes. To improve safety when pickling, Avesta Finishing Chemicals has developed a unique low-fuming pickling spray which reduces the toxic nitric fumes by 50 %.

Standard applications

Avesta RedOne™ Pickling Spray 240 is universal and suitable for spray pickling larger surfaces of all stainless steel grades. High alloyed steels and duplex steels may need more than one treatment.

Characteristics

Restores stainless steel surfaces that have been damaged during fabrication operations such as welding, forming, cutting and blasting. It removes weld oxides, the underlying chromium-depleted layer and other defects that may cause local corrosion.

Improved pickling result, offers a brighter surface with less discolouration than classical products.

Higher yield, decreased consumption, thanks to the visible red colour and its free-flowing consistency which facilitates application.

Passivation

To further improve the result we recommend passivating after pickling using Avesta FinishOne Passivator 630, which is a safer acid-free passivation method.

**[www.avestafinishing.com](http://www.avestafinishing.com)**  
**where you can find Safety Data Sheets and other useful information.**

For immersion pickling!

Avesta Pickling Bath 302 is a concentrate that should be diluted with water depending on the stainless steel grade.

#### Standard applications

The bath fluid is recommended for immersion pickling of small objects and for pickling surfaces that are time-consuming to brush or spray pickle. It can also be used for circulation pickling of pipe systems.

#### Characteristics

Restores stainless steel surfaces that have been damaged during fabrication operations such as welding, forming, cutting and blasting. It removes weld oxides, the underlying chromium-depleted layer and other defects that may cause local corrosion.

Working life; the bath fluid is consumed during usage and the effective working life of the bath fluid is determined by the amount of acids and dissolved metals. The bath fluid should hence be analysed regularly, and new acid should be added when needed in order to obtain an optimal pickling result. Avesta Finishing Chemicals may assist with this analysis service.

#### Recommended concentrations

Standard grades, such as 304 and 316: Mix 1 part 302 into 3 parts of water. A further dilution can be done if longer pickling times can be accepted.

High-alloyed grades, such as duplex grades (2205) and austenitic grades (904 L) for use in severe corrosive conditions: Mix 1 part of 302 into 2 parts of water.

Very high alloyed grades, such as super-austenitic (254 SMO) and super-duplex (2507) grades: Mix 1 part of 302 into 1 part of water.

**[www.avestafinishing.com](http://www.avestafinishing.com)**  
**where you can find Safety Data Sheets and other useful information.**

#### A heavy-duty stainless steel cleaner!

Superficial rust, oil, grease and lime deposits can occasionally appear on any stainless steel surface. Cleaning with Avesta Cleaner 401 eliminates these spots with ease, restoring the surface and returning your stainless steel to its original lustrous look, feel and finish.

#### Standard applications

Avesta Cleaner 401 is intended for a wide range of industrial cleaning applications, it offers a good general cleaning result on stainless steel surfaces.

#### Characteristics

Restores and brightens stainless steel surfaces that have been contaminated during fabrication or usage. It removes surface rust, water staining and lime deposits and organic contamination such as oil and grease.

Pre-cleans before pickling. It removes organic contaminants such as grease, oil, etc. which will inhibit pickling.

Removes atmospheric staining caused by sea water, "teastaining", rain water, "water scale" and road salt.

#### Passivation

Avesta Cleaner 401 can be used in combination with Avesta FinishOne Passivator 630, which helps to remove free iron from the surface and regenerate the protective layer in the stainless steel by speeding up the passivation process.

**[www.avestafinishing.com](http://www.avestafinishing.com)  
where you can find Safety Data Sheets and other useful information.**

#### A traditional nitric acid based, well-proven passivator

Avesta Passivator 601 is intended for use after mechanical descaling treatment of stainless steel such as grinding, polishing and blasting. These processes leave a surface which, because of remaining grinding dust and iron particles, is sensitive to corrosion. The product also restores the protective chromium oxide layer.

#### Standard applications

Avesta Passivator 601 is intended for use after mechanical descaling treatment of stainless steel such as grinding, polishing and blasting. These processes leave a surface which, because of remaining grinding dust and iron particles, is sensitive to corrosion. The product also restores the protective chromium oxide layer.

#### Characteristics

- Accelerates rebuilding of the protective layer of chromium oxide.
- Removes surface contaminants and iron particles from the stainless steel surface.

#### Surface restoration

Avesta Cleaner 401 can be used together with Avesta FinishOne Passivator 601, which helps regenerate the protective layer in the stainless steel by speeding up the natural passivation process.

**[www.avestafinishing.com](http://www.avestafinishing.com)  
where you can find Safety Data Sheets and other useful information.**

#### An acid-free passivator!

Avesta FinishOne Passivator 630 passivate without nitric or citric acid. It helps to remove free iron from the surface and regenerate the protective layer in the stainless steel by speeding up the passivation process.

#### Standard applications

Avesta FinishOne Passivator 630 is intended for a wide range of industrial passivating applications. It offers a good general passivating result on stainless steel surfaces

#### Characteristics

- Restores the passivation layer on stainless steel surfaces that have been damaged during fabrication such as grinding, brushing, blasting etc or usage.
- Improves the result after pickling by speeding up the passivation process.
- Diminishes the risk of discoloured surfaces caused by flash clouds or free iron (smut) when used wet-on-wet.
- Reduces the formation of toxic nitric fumes during rinsing after pickling.
- Prevents water staining caused by poor rinse water.
- Creates no hazardous waste and contains no nitric acid.
- Is easy to handle and classified as non-dangerous goods.

#### Surface restoration

Avesta Cleaner 401 can be used together with Avesta FinishOne Passivator 630, which helps regenerate the protective layer in the stainless steel by speeding up the thickness of the passive layer.

**[www.avestafinishing.com](http://www.avestafinishing.com)**  
**where you can find Safety Data Sheets and other useful information.**



### Overview

The selection of the welding process is an important aspect of creating an economical welded joint. This section attempts to characterise briefly the various welding procedures and to clarify their main advantages and disadvantages.

## 7.1 Manual metal arc welding with covered electrodes

In manual metal arc welding with covered electrodes, the coating fulfils the task of, on the one hand, creating a shroud of shielding gas and, on the other, of forming a slag in order to stop oxygen reaching the transferring drops of metal or the weld metal. The shield has an important effect on the welding properties and the mechanical properties of the weld metal, especially at negative temperatures. In addition, the coating has an effect on positional weldability, on deposition efficiency, and on compensation for burn-off.

There are three main types of coating: rutile, basic and cellulose-coated stick electrodes, and mixtures of these types.

### Rutile coated stick electrode (R)

This type of coating is the one most widely used in practice. This is because it offers a range of advantages such as:

- Very stable arc, making it easy for the welder to handle
- DC or AC power can be used for welding
- Good ignition and re-ignition properties
- Suitable for all welding positions except for vertical down (PG) - depending on the thickness of the coating and on the type of weld metal (high-alloy is restricted in the vertical-up (PF) and overhead (PD, PE) positions.
- Easy slag removal, finely structured, smooth seam, particularly for the thickly coated RR types (preferred for fillet welds and cover passes)
- No redrying is necessary (except for high-alloy)

T

- Cannot be used for thick-walled and stressed components (more than 20 - 25 mm)
- Inadequate impact energy at negative temperatures
- Higher hydrogen content (20 ml/100 g weld metal)
- Cannot be used for higher-carbon steels (C < 0.2%)

### Basic coated stick electrode (B)

Basic coated stick electrodes feature excellent toughness, in particular in the low temperature range. Other advantages include:

- Extremely low hydrogen content (< 5 ml / 100 g).
- No restriction on wall thickness
- Can be used for all welding positions other than vertical down (PG); basic vertical down electrodes are also suitable for this position
- Also suitable for welding higher-carbon steels (C > 0.2%).



## 7.2 Tungsten inert gas welding (TIG process)

In the TIG method, a burning arc is used as the source of heat under the protection of an inert gas. Tungsten rods, pure or alloyed, are used as the electrode.

The shielding gas consists of argon, helium, or of mixtures of argon and helium. The shielding gas serves a number of purposes here. It protects the extremely hot tungsten electrode from oxidation by atmospheric oxygen, cools it, and permits the formation of a stable arc. At the same time, the liquid metal pool and the melting filler wire are protected from the atmospheric air.

In TIG welding, the welding consumable is supplied, without current, at the side of the molten pool. For manual welding, the consumable material is supplied as sticks with a length of 1 m, and as wire rolled onto spools for TIG cold wire welding by machine. TIG hot wire welding is a further variant, in which the filler wire is heated, using electrical resistance heating, as it is supplied, in order to increase the deposition rate.

In the case of steels and nickel-based alloys, welding is carried out almost exclusively with DC, the electrode being on the negative pole. Guide figures are provided in the following table, indicating how much current the tungsten electrode can carry, according to the diameter:

### Guide figures for the maximum current carried by tungsten electrodes:

Electrode diameter mm	Welding current A	
	Pure tungsten electrode	Alloyed tungsten electrode
1.0	25 - 70	max. 0
1.6	50 - 110	15 - 150
2.4	0 - 160	50 - 220
3.2	120 - 220	0 - 320
4.0	150 - 300	120 - 400

The applications extend from welding thin plates up to the high-quality root welding of thick plates and pipes. It is also used for welding non-ferrous metals.

## 7.3 Gas shielded metal arc welding (MIG/MAG process)

The MIG/MAG process is a form of gas shielded arc welding by machine, in which the arc burns under shielding gas between the wire electrode, which carries the current, and the workpiece. A wire electrode, supplied from a roll by machine, acts as the electrode and melts in its own arc.

Argon, helium, or mixtures of these gases, are used as the shielding gas in the MIG process. In the MAG process, shielding gases of argon with the addition of oxygen, helium with added oxygen, carbon dioxide (CO<sub>2</sub>), or mixtures of these gases are used. The shielding gas allows a stable arc to be formed, and prevents atmospheric air from reaching the liquid weld pool. The addition of some oxygen to the shielding gases reduces the surface tension of the molten pool, resulting in the formation of a smoother seam surface and good transitions to the edges of the seam. In addition, the transfer of material within the arc occurs with finer drops.

The resulting burn-off of alloy components is compensated for through appropriate over-alloying of the wire electrodes. It is essential to make sure that the welding area is free from draughts. When welding speeds are high and with rapid weaving, it is necessary to make sure that the liquid weld pool is properly screened by shielding gas through the use of a suitable quantity of shielding gas and the right nozzle shapes.

Only DC converters or rectifiers can be used as the source of current. The electrode is usually on the positive pole.

### Summary of the various types of arc used for MIG/MAG welding

Arc type	Application	Material transfer	Spatter formation	Comments
Short arc	Thin plate, out-of-position, root welds	In short circuit, large drops	Low with the right current source	Low heat input, low deposition rate
Transitional arc	Medium plate thickness, out-of-position	Material transfer partly in short circuit	Some spatter adhering to the workpiece	Medium performance
Spray arc	Medium and thick plate in the PA, PB positions	Fine droplet material transfer without short-circuits	Low	High deposition rate
Long arc (under CO <sub>2</sub> or with a high proportion of CO <sub>2</sub> in the shielding gas)	Medium and thick plate in the PA, PB positions	Material transfer partly in short circuit	Some spatter adhering to the workpiece	High deposition rate
Pulsed arc	Wide working range	No short circuits, 1 drop per pulse	Very low	More heat input than with short arc

Welding with a short arc is preferably done using wires with diameters 0.8 - 1.0 mm, in some cases also using dia. 1.2 and 1.6 mm. This method requires the use of a suitable current source with an adjustable no-load voltage and, in some cases, also with an adjustable characteristic curve. Depending on the diameter of the wire, the arc voltage is between 14 and 22 V, with currents of between 60 and 200 A.

## 7.3 Gas shielded metal arc welding (MIG/MAG process)

Since the weld pool is significantly cooler, thin plate with thicknesses of 0.8 mm upwards can easily be welded. As a result of the exceptional gap bridging, and since the rear of the root is smooth, this method is also used for root welding at greater wall thicknesses, and for out-of-position welding. The following table contains guide figures for current, voltage, wire feed rate and the deposition rate for the short arc.

wire diameter mm	current A	voltage	feed rate m min	deposition efficiency g h
0.8	60 - 130	15 - 17	2.9 - 13.0	0.7 - 2.9
1.0	70 - 160	16 - 19	2.4 - 7.1	0.9 - 2.9
1.2	100 - 160	17 - 20	2.1 - 5.4	1.1 - 2.9

T

With a transitional arc, the transfer of material takes place in an irregular sequence, both with and without short circuits. As a result, the tendency for spatter to adhere to the workpiece is increased. Because its performance is higher than that of the short arc, transitional arc welding is used for the filler and cover passes in medium plate thickness, and in some cases also for vertical down welding.

The following table contains guide figures for current, voltage, wire feed rate and the deposition rate for the transitional arc.

wire diameter mm	current A	voltage	feed rate m min	deposition efficiency g h
0.8	110 - 140	1 - 22	6.0 - 9.0	1.3 - 1.9
1.0	130 - 160	1 - 24	5.0 - 7.5	1.7 - 2.5
1.2	170 - 240	19 - 26	5.0 - 7.5	2.4 - 3.6

### Long arc (only under CO<sub>2</sub> and shielding gases with more than 20-25% CO<sub>2</sub>)

The term long arc is used for drop transfers in which free transfers and short-circuit transfers are mixed. The drops are larger than with the spray arc. A long arc is formed when welding with carbon dioxide or mixed argon gases with more than 20% carbon dioxide. Since the drop transfer takes place partly with short circuits, larger spatter losses can occur.

In the upper performance range, the field of application of the long arc is similar to that of the spray arc. In the lower to medium performance range, it can often also be used for out-of-position welding.

Vertical down seams can be reliably welded, above all using the CO<sub>2</sub> arc. As the proportion of carbon dioxide in the shielding gas rises, so do the resistance to porosity and the reliability of the fusion penetration. The application of the long arc is strictly restricted to welding of unalloyed and low alloy steels.

### Spray arc (only under argon-rich shielding gases with more than 80% Argon)

Welding with a spray arc is primarily done using wires with diameters 1.0 to 1.6 mm, in some cases also using 0.8, 2.0 and 2.4 mm. The main field of application is normal joint welding of workpieces more than 4 mm thick, and in build-up welding applications.

In spite of the higher price of the wire, the small wire diameter brings economic advantages, since, as a result of the higher specific current density in the wire electrode (up to 300 A/mm<sup>2</sup>), the deposition rate at a given current magnitude and arc voltage is noticeably increased.

Mixed gases generally result in a material transfer with finer drops, and therefore to a more stable arc, as well as to reduced spatter formation. The spatter can, moreover, also be reduced by keeping to the lower limit of the arc voltage.

## 7.3 Gas shielded metal arc welding (MIG/MAG process)

The following table contains guide values for the current, voltage, wire feed rate and deposition rate of various wire diameters for carbon and low-alloy steels. Medium values are selected for manual welding, whereas the higher values are used for machine welding. The current should be set 10 - 15% lower for austenitic wire electrodes.

Wire diameter mm	Current intensity A	Voltage	Feed rate m/min	Deposition efficiency g/h
0.8	140 - 190	22 - 26	4.0 - 15.0	2.1 - 3.7
1.0	170 - 260	23 - 27	3.5 - 12.0	2.4 - 4.0
1.2	220 - 320	25 - 30	2.5 - 10.0	2.0 - 4.6
1.6	260 - 390	26 - 34	2.0 - 6.0	3.2 - 6.2
2.4	340 - 490	30 - 36	2.5 - 3.5	3.2 - 5.0
3.2	400 - 500	34 - 38	1.2 - 2.2	4.5 - 5.5

An extension to welding with a spray arc is welding with the addition of a cold wire that carries no current. A second wire, without current, with a diameter 1.6 mm or 2.4 mm, is introduced from the side into the arc. The deposition rate is increased by up to 80%, and the melting losses and fusion penetration are significantly reduced. This is advantageous for build-up welding. The method has also proven effective for filling large seam cross sections.

### P

With the pulsed arc it is possible to achieve short-circuit-free, low spatter release of the drops from the wire electrode. This is also achieved at low arc powers, which otherwise would lead to short arcs (or even long arcs) and thus to short-circuits with spatter formation. The welding current is pulsed, and the following processes thus occur in the welding:

The arc burns at a small background current intensity, melting the wire electrode and the base material.

An increased pulse current overlays the background current, releasing one or more drops that transfer, without short-circuit, to the weld pool.

The magnitude of the current falls back to that of the background current, the arc burns until the next current pulse.

The number of drops can be controlled selectively through the pulse frequency.

The pulsed arc technique allows thicker wire electrodes to be used, which therefore are easier to feed. Depending on the particular application – thinner (from 2 mm upwards) or thicker plate – root, filler or cover pass welding – out-of-position – the pulse frequency can be changed to achieve optimum parameters with spatter-free drop transfer.

Argon-rich mixed gases with a maximum of 18% carbon dioxide can be used as the shielding gas. The particular advantages of the pulsed arc are found with materials such as aluminium or nickel, and with corrosion-resistant chromium or chromium-nickel (molybdenum) steels. Due to the controlled heat input, welding on high-strength fine-grained structural steels or low-temperature steels is also effective.

The following table contains guide figures for current, voltage, wire feed rate and the deposition rate for the pulsed arc.

Wire diameter mm	Current A	Voltage	Feed rate m/min	Deposition efficiency g/h
1.0	100 - 200	20 - 32	3.0 - 12.0	1.0 - 6.0
1.2	100 - 340	22 - 35	2.0 - 12.0	0.9 - 5.5

## 7.3 Gas shielded metal arc welding (MIG/MAG process)

The choice of the shielding gas is determined by the alloys of the materials to be welded and by the requirements placed on the quality of the seam and the freedom from spatter. Carbon dioxide (CO<sub>2</sub>) is primarily used for welding unalloyed structural steels and for armouring against wear. Mixed gases are preferred for welding unalloyed and low-alloy steels, such as the creep-resistant steels used for the manufacture of boilers and pipelines. The high quality of the seams, the good, even fusion penetration and substantial freedom from spatter satisfy the requirements placed on high quality welds.

Argon, with the addition of 1 - 5% oxygen or of 2 - 3% CO<sub>2</sub> are primarily used for welding high-alloy ferritic and austenitic welding consumables. The melting losses of the alloy components is lower than is the case with mixed gases and carbon dioxide, while the material transfer occurs with very fine drops and is almost free of spatter.

### Classification of shielding gases according to EN ISO 14175

Symbol		Components in vol.						Usual application	Comments
Main group	Sub-group	Oxidising		Inert		Re-reducing	Low reactivity		
		CO <sub>2</sub>	O <sub>2</sub>	Ar	He	H <sub>2</sub>	N <sub>2</sub>		
I	1			100				MIG, WIG, plasma welding	inert
	2					100			
	3			bal.		0.5 - 95			
M1	1	0.5 - 5		bal. <sup>a</sup>		0.5 - 5		MAG	Weak reducing
	2	0.5 - 5		bal. <sup>a</sup>					
	3		0.5 - 3	bal. <sup>a</sup>					
	4	0.5 - 5	0.5 - 3	bal. <sup>a</sup>					
M2	0	5 - 15		bal. <sup>a</sup>					
	1	15 - 25		bal. <sup>a</sup>					
	2		3 - 10	bal. <sup>a</sup>					
	3	0.5 - 5	3 - 10	bal. <sup>a</sup>					
	4	5 - 15	0.5 - 3	bal. <sup>a</sup>					
	5	5 - 15	3 - 10	bal. <sup>a</sup>					
	6	15 - 25	0.5 - 3	bal. <sup>a</sup>					
M3	7	15 - 25	3 - 10	bal. <sup>a</sup>					
	1	25 - 50		bal. <sup>a</sup>					
	2		10 - 15	bal. <sup>a</sup>					
	3	25 - 50	2 - 10	bal. <sup>a</sup>					
	4	5 - 25	10 - 15	bal. <sup>a</sup>					
C	5	25 - 50	10 - 15	bal. <sup>a</sup>				Strong oxidising	
	1	100							
R	2	bal.	0.5 - 30					WIG, plasma welding, plasma cutting, back purging	Reducing
	1			bal. <sup>a</sup>		0.5 - 15			
N	2					15 - 50		Plasma cutting Root shielding	Reducing low reactivity
	1						100		
	2			bal. <sup>a</sup>			0.5 - 5		
	3			bal. <sup>a</sup>			5 - 50		
	4			bal. <sup>a</sup>		0.5 - 10	0.5 - 5		
O	5					0.5 - 50	bal.	Plasma cutting	Strongly oxidising
	1		100						
Z	Mixed gases with components that are not listed in the table, or mixed gases with a composition outside the given ranges. <sup>b</sup>								

<sup>a</sup> For this classification, argon can be partly or entirely replaced by helium.

<sup>b</sup> Two mixed gases with the same Z-classification must not be exchanged for one another.

## 7.4 Joint welding with flux cored wires

Welding with flux cored wires, like welding with a solid wire electrode, is a metal-arc welding process with a melting electrode, and the two are therefore basically comparable. Whereas solid wires always demonstrate a similar melting characteristic, depending on the selection of welding parameters, the welding properties and the deposition rate, the suitability for various positions, and the mechanical properties obtained when using flux cored wires are, however, strongly influenced by the powder filling.

There are gas-shielded flux cored wires for which the shielding gas must be supplied from outside, as well as self-shielding wires which generate their own shielding gas in the welding process. Böhler Schweißtechnik offers 2 self-shielding flux cored wires, particularly for the vertical down position on pipelines:

- Böhler Pipeshield 71 T8-FD for pipe steels up to API X60 (L415NB/MB) (Ni < 1%)
- Böhler Pipeshield 71.1 T8-FD for pipe steels up to API X60 (L415NB/MB)
- Böhler Pipeshield 81 T8-FD for pipe steels up to API X70 (L485MB)

Amongst the gas shielded flux cored wires, we distinguish 2 types of flux cored wire: metal powder and slagging rutile or basic flux cored wires.

The core of the metal powder flux cored wires primarily consists of metal alloys, iron powder and elements that stabilise the arc. The surface of the weld seam is without slag, although isolated islands of silicate are possible, depending on the shielding gas and on the base material. The material transfer takes place in fine drops, and with little spatter. The current carrying capacity and the deposition rate are high. The arc is wide, stable, and has very good gap bridging capability. The ability to process with a short arc is very good, with or without pulses, and it is well-suited to automatic welding processes. PA, PB and PC are the preferred welding positions.

The two bestseller of our broad product range of metal cored wires are:

BÖHLER CN 13/4-MC	Stainless	For soft martensitic materials such as 1.4313
BÖHLER A 7-MC	Stainless	For welding dissimilar joints and steels that are difficult to weld

The core of the slagging flux cored wires primarily consists of slag-forming materials, metal alloys, iron powder and elements that stabilise the arc. Amongst the rutile flux cored wires, we distinguish 2 types:

with a fast solidifying slag, the P-type (according to standard) for all positions apart from vertical down

With a slow solidifying slag, the R-type (according to standard) for the PA, PB and PC positions

## 7.4 Joint welding with flux cored wires

The basic flux cored wires only include the type with a slag that solidifies at normal speed. Both types of the high-alloy rutile flux cored wires, i.e. those with the fast and slow solidifying slag, are used; the reason for this is the better surface of the seam obtained from the type with the slow solidifying slag.

The unalloyed, creep resistant and higher-strength flux cored wires are usually of the fast solidifying type. The advantage of the type with the fast solidifying slag derives from the supporting effect of the slag, making it possible to use higher currents. The arc of the rutile flux cored wires is soft and very stable, and the material transfer takes place with very fine drops and little spatter. As a result of the shielding effect of the slag as the material is transferred, M21 (15-25% CO<sub>2</sub>) can also be used as the shielding gas for high-alloy flux cored wires. Rutile flux cored wires only weld in the spray arc range; root welding is only possible with a backing.

Basic flux cored wires can also be used for welding in all positions, although the highly fluid slag provides no support, so that welding in difficult positions (PF, PD, PD) can only be done with a reduced current. The material is transferred in fine to medium sized drops, root welds can be done with or without backing. The main advantage of these flux cored wires lies in the weld metal which is crack-resistant and tough even at negative temperatures, allowing any wall thickness to be welded. Basic flux cored wires can also be used to weld with a short arc, with or without pulse.

The range of our most common slagging (rutile) flux cored wires are listed below:

BÖHLER Ti 52-FD	unalloyed	For steels up to 460 MPa (0.2 offset yield strength)
BÖHLER Ti 70 Pipe-FD	High strength	For (pipe) steels up to 550 MPa (0.2 offset yield strength)
BÖHLER Ti 60-FD	High strength	For (pipe) steels up to 500 MPa (0.2 offset yield strength)
BÖHLER DMO Ti-FD	Creep resistant	For creep resistant steels such as 16Mo3
BÖHLER DCMS Ti-FD	Creep resistant	For creep resistant steels such as 13CrMo4-5
BÖHLER EAS 2-FD	Stainless	For standard austenite without Mo such as 1.4301, 1.4541
BÖHLER EAS 2 PW-FD	Stainless	For standard austenite without Mo such as 1.4301, 1.4541
Thermanit TG 308 L	Stainless	For standard austenite without Mo such as 1.4301, 1.4541
Avesta FCW-2D 308L/MVR	Stainless	For standard austenite without Mo such as 1.4301, 1.4541
Avesta FCW 308L/MVR-PW	Stainless	For standard austenite without Mo such as 1.4301, 1.4541
BÖHLER SAS 2-FD	Stainless	For stainless steel like 1.4546, 1.4550 or AISI 347, 304L
BÖHLER SAS 2 PW-FD	Stainless	For stainless steel like 1.4546, 1.4550 or AISI 347, 304L
Avesta FCW-2D 347/MVNB	Stainless	For stainless steel like 1.4546, 1.4550 or AISI 347, 304L

## 7.4 Joint welding with flux cored wires

BÖHLER EAS 4 M-FD	Stainless	For standard austenite with Mo such as 1.4401, 1.4404, 1.4571
BÖHLER EAS 4 PW-FD	Stainless	For standard austenite with Mo such as 1.4401, 1.4404, 1.4571
BÖHLER EAS 4 PW-FD (LF)	Stainless	For stainless steel with Mo and a ferrite content 3-6 FN with excellent cryogenic toughness at -196°C
Avesta FCW-2D 316L/SKR	Stainless	For standard austenite with Mo such as 1.4401, 1.4404, 1.4571
Avesta FCW 316L/SKR-PW	Stainless	For standard austenite with Mo such as 1.4401, 1.4404, 1.4571
Thermanit TG 316 L	Stainless	For standard austenite with Mo such as 1.4401, 1.4404, 1.4571
Avesta FCW-2D 2205	Stainless	For duplex steels such as 1.4462
Avesta FCW 2205-PW	Stainless	For duplex steels such as 1.4462
Avesta FCW-2D LDX 2101	Stainless	For lean duplex steels such as 1.4162, 1.4362
Avesta FCW LDX 2101-PW	Stainless	For lean duplex steels such as 1.4162, 1.4362
Avesta FCW 2507/P100-PW	Stainless	For super duplex steels such as 1.4501
BÖHLER A 7-FD	Stainless	For welding dissimilar joints and steels that are difficult to weld
BÖHLER A 7 PW-FD	Stainless	For welding dissimilar joints and steels that are difficult to weld
BÖHLER CN 23/12-FD	Stainless	For dissimilar joints and claddings
Thermanit TG 309 L	Stainless	For dissimilar joints and claddings
BÖHLER CN 23/12 PW-FD	Stainless	For dissimilar joints and claddings
Avesta FCW 309L-PW	Stainless	For dissimilar joints and claddings
BÖHLER CN 23/12 Mo-FD	Stainless	For dissimilar joints and claddings with Mo
BÖHLER CN 23/12 Mo PW-FD	Stainless	For dissimilar joints and claddings with Mo
BÖHLER NIBAS 70/20-FD	Nickel-based	For nickel alloys such as 2.4816 and for dissimilar joints
BÖHLER NIBAS 70/20 Mn-FD	Nickel-based	For nickel alloys such as 2.4816 and for dissimilar joints. Due to the higher Mn content high resistant against hot cracks.
UTP AF 068 HH	Nickel-based	For nickel alloys such as 2.4816 and for dissimilar joints
BÖHLER NIBAS 625 PW-FD	Nickel-based	For nickel alloys such as 2.4856, 2.4858, alloy 625 and for dissimilar joints
UTP AF 6222 MOPW	Nickel-based	For nickel alloys such as 2.4856, 2.4858, alloy 625 and for dissimilar joints
Avesta FCW P12-PW	Nickel-based	For nickel alloys such as 2.4856, 2.4858, alloy 625 and for dissimilar joints



## 7.5 Explanations of submerged arc welding

Submerged arc welding requires a welding consumable (wire, strip or flux cored wire) and a non-metallic auxiliary material, the welding flux.

The welding flux has a very significant effect on the resulting weld. As a result of the melting behaviour and of various physical properties such as viscosity, surface tension, density, thermal expansion and electrical conductivity it has a very strong effect on the appearance of the seam and on the slag detachability.

The effect of the welding flux, through the metallurgical reaction, on the chemical composition and therefore the mechanical properties of the weld metal is of great importance.

Depending on the method of manufacture a distinction is made between:

- e** code F (fused)  
Made by melting in an electric arc furnace homogenous, not sensitive to moisture, resistant to abrasion, but a very limited metallurgical reaction, high apparent density and relatively poor slag detachability.
- mera e** code A (agglomerated), e.g. UV 420 TT.  
Manufactured through agglomeration followed by drying in a rotary kiln very good metallurgical reaction, low apparent density, good slag detachability, possibility of additional alloying, but sensitive to moisture and abrasion.

12

According to the basicity, the welding flux is classified into acid, neutral and basic welding flux. The basicity is calculated from

$$B = \frac{\text{basic constituents (CaO, CaF}_2, \text{MgO, MnO)}}{\text{acid constituents (SiO}_2, \text{TiO}_2, \text{ZrO}_2)}$$

If B is less than 1 we speak of an acid welding flux (predominantly acidic constituents) at a value between 1 and 1.2 it is considered neutral above that we speak of a basic welding flux, and above 2 of a highly basic welding flux.

The following fluxes are in common use, classified according to their main constituents:

- a a e e e a e e** (MS), predominantly MnO and SiO<sub>2</sub>.
- a m a e e e** (MS), predominantly CaO, MgO and SiO<sub>2</sub>.
- m a e r e e** (AR), predominantly Al<sub>2</sub>O<sub>3</sub> and TiO<sub>2</sub>.
- m a e a** (AB), predominantly Al<sub>2</sub>O<sub>3</sub>, CaO and MgO
- r e a** (FB), predominantly CaO, MgO, MnO and CaF<sub>2</sub>

Other flux types are defined in the EN ISO 14174 standard.

Each type of flux has its own specific properties that must be taken account when making the selection for practical application.

### Overview

The biggest problem in the selection of welding consumables is that of correctly assessing the metallurgical behaviour of the materials that are to be welded.

The whole welding technique, preheating, and any subsequent heat treatment that might be necessary all revolve around this.

This section attempts to discuss the most important technical welding aspects of various typical materials groups in a few relatively brief chapters. As far as possible, a general outline will be given of the required welding technique.

The last chapter in this section approaches the altogether more complex problem of dissimilar joints. Since a detailed treatment would be the size of a book, this chapter just contains short notes on how various combinations of typical groups of materials are to be treated.

## 8.1 Welding suitability of the steels

The following factors are the main influence on the welding suitability of the steels: composition, manufacture, treatment and physical properties. The composition is of central importance, as this is the main thing that determines the strength and the deformation properties.

### Suitability of unalloyed steels for welding

Leaving aside the phosphorus and sulphur content, the suitability of unalloyed steels for welding is mainly judged according to the carbon content. As a result of the welding heat, part of the base material is austenitised at the edge of the welding seam. Following the rapid cooling immediately following the weld, local hardening and hydrogen embrittlement can occur in the affected zone. Unalloyed steels with carbon contents up to about 0.22% can usually still be welded without difficulty; at higher-carbon levels and Mn contents of above 1%, base materials with a wall thickness of about 20 mm or more must be preheated, in order to reduce the cooling speed involved in the austenitised conversion. Steels with a C-content of more than about 0.5% are generally not considered suitable for welding. Nevertheless, the carbon content alone is not sufficient to determine the suitability of unalloyed steels for welding. Welding difficulties can occur as a result of higher hydrogen, nitrogen and oxygen contents, as well as due to the presence of strong segregation. Wall thickness and the stress level also play an important role.

### Suitability of alloyed steels for welding

Steels with alloy contents up to 5%

According to their properties when in use, these steels are divided into, for example, creep resistant, high-strength and cryogenic. The steels often require appropriate heating prior to, during and after welding if usable welded joints with particular properties are to be achieved. The chemical composition in terms of the type and quantity of alloying constituents, and the microstructure, are important. Higher strength quenched and tempered steels usually have C-contents between 0.2 and 0.6%. Chromium, nickel and molybdenum are important alloying elements, and so are manganese, silicon and vanadium. Their increased tendency to form martensite leads to higher tensions in the component as the weld seam cools. The critical cooling rate is less, which means that it is possible for hardened microstructures to form even under air cooling, and this can impair the ability of the welded joint to deform. There is a high risk of hardening cracks in the transition zones. On the other hand, due to the tempering effect, zones with marked softening can also occur. Since there are no same-type welding consumables for these steels it is not generally possible to create joints with the properties of the base material.

Steels with alloy contents > 5%

The stainless steels, containing either simply chromium or both chromium and nickel as the characteristic alloying elements, constitute an important group.

The chromium steels are mainly divided into types with ferritic or with martensitic microstructures, which are classified as having only limited suitability for welding. The reason for this is the tendency of the ferritic chromium steels to form coarse grains, and the tendency of the martensitic chromium steels to harden in the heat affected zone of the base material.

In contrast, the austenitic CrNi(Mo) steels are well-suited to welding. However, if they are not properly processed, the corrosion resistance, hot cracking resistance and toughness of these steels can be negatively affected. Certain basic rules must therefore be followed when welding stainless steels.

## 8.2 Unalloyed structural and fine-grained structural steels

Structural steels are low carbon steels with a specified carbon equivalent value (CEV) in which the carbon content lies between 0.10 and 0.60%. The steels coded with S, such as S185, S235JR+AR and S355J2+N, are used in steel construction, while those coded with E, such as E292, E335, E360, are used in mechanical engineering. The structural steels are standardised in EN 10025-2. Structural steels are either hot formed in the production condition (AR=As Rolled), normalised (N) or cold formed. In most cases the mechanical properties are adequate. Structural steels can be welded, and can be stress-relieved.

The weldability of structural steels identified as S185, E295, E335 and E360 is limited as their carbon content is either not specified (S185) or is too high (E295, E335, E360), and must not be used in steel constructions that are subject to acceptance tests. Fine-grained structural steels are steels with a fine-grained structure (ferrite grain size  $\leq 6$ ), a carbon content of at most 0.20%, a limited carbon equivalent value, as a result of which they have very good welding properties. Their toughness, including at low temperatures, is improved over structural steels, and they are resistant to ageing.

Only the unalloyed fine-grained structural steels with a minimum yield strength of 275-460 MPa are considered in this chapter. They are either normalised, or are normalised rolled (code N) as standardised in EN 10025-3, or thermomechanically rolled (code M) as standardised in EN 10025-4.

The cryogenic variant of the fine-grained structural steels, with the additional code L, can be used down to  $-50^{\circ}\text{C}$ . Without additive, use is limited to  $-20^{\circ}\text{C}$ . Sufficient low-temperature toughness must therefore be attended to when selecting the welding consumables.

The welding of higher-strength fine-grained structural steels is treated in a chapter further below.

### **Welding unalloyed structural and fine-grained structural steels**

As a rule, the same mechanical and technical properties are expected from welding consumables used for a welded joint as are found in the corresponding base material. As the carbon content rises, the suitability of the steel for welding falls due to hardening. In the case of steels whose suitability for welding is not certain, corresponding measures therefore have to be taken in order to avoid unacceptably high levels of hardening and the cracks that result. Options for predicting the tendency to hardening include the carbon equivalent value, as well as the TTT curves and the welding TTT curves. If necessary it is also possible to carry out a practical welding test followed by an examination of the microstructure or by hardness tests. As a rule of thumb, it can be said that the hardening in the transition zone of unalloyed structural steels should not exceed 350 HV (Vickers hardness units).

### **Welding technology for unalloyed structural and fine-grained structural steels:**

The welding consumables are to be selected in accordance with the minimum requirements for the mechanical properties of the base material.

Steels with „guaranteed welding suitability“ and with wall thicknesses of 30 mm or even 20 mm upwards – depending on strength – should be preheated to  $100 - 150^{\circ}\text{C}$ ; if stick electrodes are used, they should only be basic types. Steels with only „limited suitability for welding“ should always be preheated in line with the carbon equivalent value, and only basic, redried welding consumables should be used.

As the component becomes thicker, the internal stresses caused by the local heating and cooling can reach the yield strength and can exceed it when the operating stresses are added on top. The result is cold deformation, ageing and embrittlement. For this reason, steels with guaranteed suitability for welding should also be preheated above a certain wall thickness.

The following limits to reliably weldable wall thickness, depending on the strength, provide a guide:

## 8.2 Unalloyed structural and fine-grained structural steels

The following limits to reliably weldable wall thickness, depending on the strength, provide a guide:

Strength [MPa]	Thickness limit [mm]
up to 355	30
> 355 - 420	20

Walls thicker than this always require preheating to 100 - 150°C. (See also the Notes on Preheating Materials chapter for information about preheating)

## 8.3 Welding pipelines

Oil and natural gas are at present the most important sources of energy. Massive transport pipelines either already exist or are in the project planning stage around the world. The development of new, higher-strength tube steels is now putting tighter requirements on the welding technology. Thanks to our specially developed electrodes, which are ideally matched to individual steels, we can fully satisfy these requirements as well as the strict safety regulations. In most cases, the circumferential pipe welds are manufactured as vertical down welds using cellulose coated stick electrodes. The progress of construction largely depends on the speed with which these seams can be fabricated. This method makes it possible to weld using an electrode with a larger diameter, higher currents and higher welding speeds. This brings significant economic advantages when compared with the otherwise usual welding of a vertical up weld using rutile or basic coated stick electrodes.

Welding with basic coated stick electrodes, both for the vertical up and vertical down positions, is treated below in the „Welding with cellulose coated stick electrodes“ section. Böhler Welding offers a complete range of types for exceptional low temperature stress.

Please enquire separately about wires for gas shielded arc welding or submerged arc welding.

### Welding with cellulose coated stick electrodes

AWS Designation A 5.5	A 5.1	Used for pipeline steels according to API spec. 5L
BÖHLER FOX CEL	E6010	A, B, X 42, X 46, X 52, X 56, (X60, X 65, X 70, X 80*)
BÖHLER FOX CEL +	E6010	A, B, X 42, X 46, X 52, X 56, (X60, X 65, X 70, X 80*)
Phoenix CEL 70	E6010	A, B, X 42, X 46, X 52, X 56, (X60, X 65, X 70, X 80*)
BÖHLER FOX CEL 70-P	E7010-P1	X 52, X 56, X 60
BÖHLER FOX CEL 75	E7010-P1	X 52, X 56, X 60
Phoenix CEL 75	E7010-P1	X 52, X 56, X 60
BÖHLER FOX CEL Mo	E7010-P1	X 52, X 56, X 60
BÖHLER FOX CEL 80-P	E8010-P1	X 56, X 60, X 65, X 70
BÖHLER FOX CEL 85	E8010-P1	X 56, X 60, X 65, X 70
Phoenix CEL 80	E8010-P1	X 56, X 60, X 65, X 70
Phoenix CEL 90	E9010-G	X 65, X 70, X 80
BÖHLER FOX CEL 90	E9010-G	X 65, X 70, X 80

\* Onl for root welding

The special suitability of the BÖHLER FOX CEL electrodes for root welding even of high-strength steels is particularly worth noting. Through the use of BÖHLER FOX CEL for the root and, if necessary, for the hot pass, in the form of what is known as „combination welding“, the welding technology developed by Böhler Welding provides the greatest security against cracks.

It is of great importance to carefully prepare the seam if a perfect welded joint is to be achieved. Close tolerances cannot generally be achieved with flame-cut edges. In practice, the pipe ends are usually prepared by machining.

In order to avoid pores and lack of fusion, the edges of the seam must be free from foreign materials such as oil, lubricant, scale or dirt. Scoring and notches also upset the handling of the electrode. The BÖHLER FOX CEL Ø 2.5 or Ø 3.2 mm electrode is recommended for the root pass on pipes with a smaller diameter (up to 250 mm).



## 8.3 Welding pipelines

Designation	AWS classification 5.5	Use for pipeline steels according to API spec. 5L
FOX BVD 85	E8045-P2	A, B, X 42 - X 65
FOX BVD 90	E9045-P2 (mod.)	X 70, X 80
FOX BVD 100	E10045-P2 (mod.)	X 80
FOX BVD 110	E11018-G	X 100
FOX BVD 120	E12018-G	X 110

### Performing the welding

Joint preparation: The joint is prepared by machining. The permissible dimensional tolerances of the tubes are listed in the API spec. 5L and EN 10208-2 standards.

Centring the tubes: As when welding with cellulose coated stick electrodes, the tubes are centred using hydraulically operated internal centring gear. Due to the relatively strong formation of the root pass, and due to the low level of hydrogen introduced by the basic coated root electrode, the internal centring gear can be removed, provided there is no excessive edge displacement, as soon as the root pass has been finished.

### Welding at low external temperatures or in wet weather

In unfavourable weather, particularly if the air temperature is less than 0°C, welding work may only be carried out on pipelines if the welding and working conditions allow the seam to be created properly. This means that although it is not forbidden to weld when the external temperature is low, certain precautionary measures must be taken.

The following rules have been found effective in practice:

1. Remove ice, frost and water by preheating.
2. Weld quickly without extended breaks, if necessary using a number of welders for one seam.
3. Use the thickest possible electrodes.
4. The welder himself must be sufficiently well protected from the cold (if necessary provide tents, wind protection or infrared heaters).

There are no generally applicable rules or restrictive specifications about carrying out welding work in the rain or on wet workpieces. Nevertheless it goes without saying that the welding area and its surroundings must be protected from rain and other bad weather. Under all circumstances, the welding area must be free from water.

Redried basic stick electrodes have in any case very little hydrogen in the weld metal, and therefore offer better security, under unfavourable conditions, against hydrogen-induced cracking. However, if welding is carried out in a water saturated atmosphere, even the basic weld metal can contain significant amounts of hydrogen.



## 8.4 High-strength fine-grained structural steels

The micro-alloyed steels can be divided into three main groups, according to how they are manufactured:

1. normalised fine-grained structural steels
2. thermo-mechanically treated fine-grained structural steels
3. quenched and tempered fine-grained structural steels

In fine-grained structural steels, the loss of strength resulting from the low carbon content is compensated for via microalloying elements such as Al, Nb, Ti and V. Through the addition of Cr, Mo and Ni together with quenching and tempering, 0.2-offset yield strengths of 1300 MPa can be achieved while retaining good toughness and welding properties.

Conventional, rolled, normalised fine-grained structural steels can be made with 0.2-yield limits of up to 460 MPa. The properties are achieved through the addition of microalloying elements.

In thermo-mechanically rolled steels, the strength is achieved through the addition of microalloying elements and through rolling processes with careful temperature control. This allows 0.2-offset yield strengths of 960 MPa to be achieved. The strength properties achieved through a thermomechanical treatment cannot be repeated.

0.2-offset yield strengths of up to 1300 MPa are achieved with quenched and tempered fine-grained structural steels. The strength is achieved through microalloying elements, the addition of Cr, Mo and sometimes of Ni, and by a quenching and tempering process following rolling.

### Welding fine-grained structural steels

The generally applicable and recognised rules for welding low-alloy, higher-strength fine-grained structural steels meeting EN 1011-2 must be followed.

It is generally necessary to ensure that as the minimum values of the 0.2-offset yield strength increase, and as the walls become thicker, greater care must be taken during processing, while a design that is appropriate for welding and for the stresses to which it will be subjected is an important prerequisite.

The risk of hot cracking is low in these steels. On the other hand, the possibility of lamellar tearing must be countered by design and/or by the welding technique (reducing internal stress, preheating). At the same time, excessive hardening must be avoided, and the hydrogen content kept as low as possible in order to minimise the risk of cold cracking.

The preheating temperature depends on the thickness of the workpiece and on the chemical composition of the base material and the weld metal, the energy input per unit length, and on the expected internal stresses. As the thickness increases, the upper range of temperatures should be aimed at. The values of the thickness limit for preheating, depending on the minimum value of the 0.2-offset yield strength of the base material, are contained in the following table.

Minimum value of the 0.2-offset Thickness limit [mm]	yield strength [MPa]
> 460 bis 550	12
> 550	8

## 8.4 High-strength fine-grained structural steels

The temperature-time curve during welding is of crucial significance to the mechanical properties of high-strength welded joints. In particular, this is affected by the plate thickness, the shape of the seam, the energy input per unit length, the preheating temperature, and the layer structure. In order to characterise the temperature-time curve during welding, the cooling time  $t_{8/5}$ , i.e. the time taken for a weld bead to cool from 800 to 500°C is usually selected. The cooling time  $t_{8/5}$  in any particular case depends on the requirements for the strength of the particular welded joints after any possible heat treatment has been carried out. A combination of welding current, arc voltage, welding speed and preheating temperature that is appropriate for the cooling time  $t_{8/5}$  to be applied is specified by the user in light of economic and production engineering factors. The selection of a suitable welding consumable is a further key factor that determines quality.

### Welding technology

Welding consumables are to be chosen that demonstrate a controlled, diffusible hydrogen content, such as basic coated stick electrodes, basic flux for submerged arc welding, basic or metal cored wires and solid wire electrodes.

The preheating and interpass temperature depends on the wall thickness, the chemical composition of the base material and of the weld metal, the energy input per unit length and on the existing internal stresses.

The temperature-time curve ( $t_{8/5}$ ) is of great significance for the mechanical properties of the welded joint. It is essential that the recommendations regarding heat input from the manufacturer of the base material and of the welding consumable are observed.

### Welding consumables

Suitable Böhler welding consumables are listed in the following summary:

Material (example)	Designation
S500Q	BÖHLER FOX EV 65, Union MoNi, BÖHLER Ti 60-FD, Union S3 NiMo
S690Q	BÖHLER FOX EV 85, BÖHLER X 70-IG, Union X 85, Union S3 NiMoCr
S890Q	BÖHLER X 90-IG, Union X 90, Union X 96

## 8.5 Low-temperature steels

The large scale industrial use of oxygen in the steel industry, nitrogen in the chemical industry, and the supply of natural gas to all industrial sectors, have become much more important in recent years. With the increased use of these gases, their economical transport and storage has become more and more important. The behaviour of gases, which change to a liquid state at low temperatures and so greatly reduce their volume, is exploited here.

This property of gases can only be used if suitable base materials and welding consumables, which have sufficiently good mechanical properties and are adequately tough at the low temperatures of the liquid gases, are available for the construction of the necessary transport and storage containers. Unalloyed, low-alloy or high-alloy steels that remain tough at low temperatures (e.g. below  $-50^{\circ}\text{C}$ ) are known as low-temperature steels. Unalloyed and low-alloy steels can in any case be used at temperatures down to  $-50^{\circ}\text{C}$ .

These groups of steels can be distinguished:

1. Unalloyed or low alloy, low-temperature and fine-grained steels for operating temperatures down to around  $-50^{\circ}\text{C}$  in a normalised state or down to about  $-60^{\circ}\text{C}$  in a quenched and tempered state.
2. Nickel alloy quenched and tempered steels with between 1.5 and 9% nickel for operating temperatures between  $-80^{\circ}\text{C}$  and about  $200^{\circ}\text{C}$ .
3. Austenitic chromium-nickel steels for operating temperatures down to about  $-269^{\circ}\text{C}$ .

### Welding low-temperature steels

The characteristic property of welding consumables for welding cryogenic materials is their ability to change shape at low temperatures. This is usually tested using the Charpy impact test. The value of the impact energy allows conclusions to be drawn about the tendency to brittle fracture and the possibilities of use down to a particular temperature.

The value of 27 joules with the Charpy V sample is often taken as the minimum value for the impact energy at the lowest operating temperature concerned.

When welding the low-temperature and fine-grained structural steels, controlled heat input must be ensured in order to keep the zone affected by the heat as narrow as possible and yet to avoid hardness peaks. Unalloyed and low-alloy basic coated types according to EN ISO 2560 and EN ISO 18275 are used for the stick electrodes. It is necessary to ensure that the hydrogen content of the welded joint is as low as possible in order to avoid cold cracking, which means that redrying the electrodes before welding, and taking them from a heated quiver, is to be recommended.

This point also applies to the welding flux used in submerged arc welding. The necessary low-temperature toughness and strength must be taken into account particularly when selecting wire-flux combinations or wire-shielding gas combinations.

When unalloyed flux cored wires are used, basic or metal cored wires are to be preferred because of the toughness and the low diffusible hydrogen content.

## 8.5 Low-temperature steels

When welding nickel-alloyed quenched and tempered steels, same type or similar type welding consumables containing between 2.0 and 3.5% Ni are used. Same-type welding consumables are preferred if, in addition to the necessary minimum temperature, the mechanical-technological properties (strength, toughness) and the physical properties (coefficient of thermal expansion) of the base material must be provided in the welded metal.

Welding consumables with higher nickel contents have a greater tendency to hot cracking. Although it is possible to weld the 5% nickel steels using austenitic welding consumables such as „A 7“ or „ASN 5“, the use of nickel-based types is preferred for this base material. Heat treatment of the welded joint must then be omitted, in the light of the austenitic weld metal (embrittlement, carbon diffusion).

The 9% Ni steel is normally joined using nickel-based welding consumables. These nickel-based types have advantages over conventional austenites, due to a higher yield strength and the possibility of giving heat treatment to welded joints. They can also be used for steels with a low nickel content.

With a limited dilution with the base material, resistance to cracking and adequate low-temperature toughness down to -200°C is achieved.

Same type welding is used on the austenitic chrome-nickel steels for low-temperature applications.

The strength of the unalloyed structural steels falls significantly at high operating temperatures; they can therefore only be used up to a temperature limit of about 350°C. Creeping and flowing processes occur in the steel under high-temperature stress, which make the permissible load become time-dependent. For that reason the design of components for operating temperatures above about 550°C is carried out using the creep strength, from which it is possible to see how long the material can support a particular stress at a particular temperature before fracturing.

Creep resistant steels therefore have sufficient mechanical strength at high operating temperatures. In addition, they must also have enough resistance to corrosion and to scaling at the operating temperature. The high-temperature strength and creep resistance are improved through the addition of particular alloying elements such as Cr, Mo, V, W, Co, Ti and Nb. In metallurgical terms, this happens through the mixed-crystal formation and the development of finely distributed special carbides and nitrides during the quenching and tempering process.

The resistance to corrosion and scaling is adjusted through the Cr content.

For temperature stresses up to 550°C, small additions of Mo, V and Cr are sufficient; Mo has the greatest effect on increasing the creep resistance. Increased scaling resistance is also required above 550°C. The 9 - 12% Cr steels with added Mo, W, Co, V and Nb may be considered for these purposes. The creep strength of quenched and tempered steels drop so significantly above 620°C that special Cr-Ni steels (base type: 16% Cr, 13% Ni) or Ni-based materials have to be used. The creep resistant steels are standardised in EN 10028-2, EN 10222-2, EN 10213, EN10216-2 and elsewhere.

### Welding the creep resistant steels

The creep resistant steels can be divided into three main groups:

#### 1. Ferritic-pearlitic steels

(65GH, P355GH and 16Mo3)

The steels are available in normalised condition. There is no risk of hardening in the zone affected by heat. Above a certain wall thickness, however, preheating to 150°C is required (P265GH = 25 mm; 16Mo3 = 15 mm.)

#### 2. Bainitic (martensitic) ferritic steels

(e.g. 13CrMo4-5, 10CrMo9-10, 14MoV6-3).

These steels are available in tempered condition, and are air-hardening, which calls for special attention when welding. Hard, brittle zones can develop through the formation of martensite in the HAZ of the base material and in the weld metal itself, and this can cause cracking. For this reason, preheating to temperatures between 100 and 300°C, depending on the type of steel, should therefore be carried out, and the interpass temperature taken into account. Since the preheating and interpass temperatures lie below the Ms temperature (Ms = 480°C), subsequent tempering is necessary at temperatures in the range between 640 740°C, depending on the steel type, but in any case below Ac3. Notes on the selection of the preheating and interpass temperatures are given in Table C5 of BS EN 1011-2.

#### 2.1 Bainitic steels

(e.g. 7CrMoVTiB10-10, 7CrWVNb9-6)

These new steel types are preferred for the construction of boiler walls. In this thin-walled range, the steels are welded, with appropriate preheating. Subsequent heat treatment is often omitted. Thicker walls are annealed at 740°C after welding.

### 3. Martensitic steels – alloy basis 12% chromium

(e.g. 12% Cr steels X20CrMo12-1, X22CrMoV12-1 and X22CrMoWV12-1).

The steels are available in quenched and tempered condition. The largely martensitic microstructure means that very careful heat control must be exercised during welding. Two different techniques have become accepted in practice, and are known as martensitic and austenitic welding. The difference lies in the preheating and interpass temperatures. For austenitic welding, this is above the Ms temperature (400 to 450°C), while in the case of martensitic welding, it is below the Ms temperature (between 200 and 250°C). After welding, the work is cooled to between 80 and 120°C, followed by heat treatment in the temperature range between 720 and 780°C. A special example of the 12% Cr steels is the new X12CrCoWVNb12-2-2 steel. This steel exhibits a high resistance to scaling together with good creep strength at temperatures up to about 650°C, and is used for superheater pipes. Preheating temperatures are 150-200°C, interpass temperatures are at most 280°C, same-type consumables are used, and subsequent heat treatment is carried out at about 770°C.

### 3.1 Martensitic steels – alloy basis 9% chromium

(e.g. X10CrMoVNb9-1, X11CrMoWVNb9-1-1, X10CrWMoVNb9-2).

In contrast to the 12% chromium types, the 9% chromium types feature, in particular because of the lower C content, a reduced tendency to harden during welding, as a result of which the risks of cold cracking and the occurrence of stress corrosion cracking are reduced. Preheating and interpass temperatures in the range between 200 and 300°C should nevertheless be provided. Because the welding technique has a significant effect on the achievable toughness of the weld metal, the use of multi-pass techniques, i.e. lower layer thicknesses, is recommended. This creates a high proportion of quenched and tempered microstructure in the weld metal, and thus improves the toughness. Prior to the necessary tempering (740 - 760°C), intermediate cooling to room temperature is necessary, in order to achieve complete martensite conversion.

#### Selecting welding consumables

Same-type alloyed welding consumables are normally used. It is only if this precondition is fulfilled that the welded joint can be expected to have a creep strength that matches the base material. Stick electrodes include those with a basic or rutile coating. Due to their poorer mechanical properties and their higher hydrogen content, the latter are only used for steels up to at most 1% Cr and wall thickness up to 12 mm. Rutile coated stick electrodes are mostly used for root welding.

TIG welding is often used for the root pass on pipes. Gas shielded metal arc welding with solid electrodes, and also particularly with flux cored wires are also becoming increasingly important, as is the SAW technique.

## 8.6 Creep-resistant steels

### Welding consumables

The following table gives examples of various Böhler welding consumables for welding creep resistant steels:

Materials	Designations
16Mo3	BÖHLER FOX DMO Kb, Phoenix SH Schwarz 3 Mk, BÖHLER DMO-IG, Union 1 Mo, BÖHLER EMS 2 Mo, Union S 2 Mo, BÖHLER DMO Ti-FD
13CrMo4-5	BÖHLER FOX DCMS Kb, Phoenix Chromo1, BÖHLER DCMS-IG, Union 1 CrMo, BÖHLER EMS 2 CrMo, Union S 2 CrMo, BÖHLER DCMS Ti-FD
10CrMo9-10	BÖHLER FOX CM 2 Kb, Phoenix SH Chromo 2 KS, BÖHLER CM 2-IG, BÖHLER CM 2-UP, Union S1 CrMo 2
X10CrMoVNb9-1	BÖHLER FOX C 9-MV, Thermanit CrMo 9V, BÖHLER C 9 MV-IG, Thermanit MTS 3, BÖHLER C 9 MV-UP
P92, NF 616	BÖHLER FOX P 92, Thermanit MTS 616,
X20CrMoWV12-1	BÖHLER FOX 20 MWV

### High pressure hydrogen resistant steels

Steels with little tendency to decarburisation by hydrogen at high pressures and temperatures, and to the embrittlement and grain boundary cracking that are associated with it, are classified as high pressure hydrogen resistant. These properties are achieved by alloying with elements that form highly stable carbides that are difficult to decompose at the operating temperature. Chromium is one such element. High pressure hydrogen resistant steels include, for example, 25CrMo4, 20CrMo9, 17CrMoV10, X20CrMoV12-1, X8CrNiMoVNb16-13 according to the steel-iron materials data sheet 590.

Hydrogen penetrates the steel at high pressure, and reacts with the carbon in the iron carbide or pearlite, forming methane. Because the methane molecules, due to their size, do not diffuse very easily, high pressures develop inside the steel, and these can result in breakup of the microstructure and finally to intercrystalline cracks.

### Welding high pressure hydrogen resistant steels

If the necessary precautionary measures are taken, high pressure hydrogen resistant steels are suitable for welding. Increasing the carbon content, however, impairs the suitability for welding. Prior to welding, these steels should be preheated to between 200 and 400°C, depending on the steel type, and this temperature must be maintained when welding.

After welding, cooling must be slow and even. The subsequent heat treatment must be carried out according to specifications. The welding consumables must also yield a weld metal that is high pressure hydrogen resistant. The X20CrMoV12-1 and X8CrNiMoVNb16-13 steels require a very special welding technique.

## 8.7 Stainless steels

The stainless steels group contains a large number of very different kinds of alloy, whose common feature is a chromium content of at least 12%. This ensures that, under oxidising conditions, an extremely thin, stable, layer of oxide forms on the surface of the steel, and the steel changes from an active (soluble) into a passive (insoluble) condition. The resistance to oxidising media is increased in the passive condition. In the presence of a reducing environment, however, i.e. when there is little available oxygen, the otherwise passive steel changes into the active condition. The chromium content of at least 12% that is required for a degree of chemical resistance of the steel, is very often referred to as the „parting limit“. The alloying element chromium, and, following on from that, nickel, are the basic elements for stainless steels. The effect that they have on the microstructure within the steel is, however, very different.

Whereas the gamma region is protected as the chromium content rises and, with 12% or more, only ferrite (body-centred cubic solid solution) is the predominant form between the solidification and room temperature, rising nickel content expands the gamma region. Above a certain nickel content, the microstructure only comprises austenite (face centred cubic solid solution) between the solidification temperature and room temperature.

The effect on the formation of the microstructure of all the other alloying elements that are added to steel in order to improve particular properties can be classified as either chromium-like or nickellike.

This means that it is possible to distinguish between ferrite-forming and austenite-forming elements, as follows. Ferrite-forming elements: chromium, silicon, aluminium, molybdenum, niobium, titanium, tungsten and vanadium.

Austenite-forming elements: nickel, manganese, carbon, cobalt, copper and nitrogen. If sufficient quantities of nickel are added to a ferritic iron-chromium alloy, it converts to the austenitic state.

The important groups of stainless steels are listed in the following table. They are divided according to the microstructure.

Microstructure	Material types
Pearlitic-martensitic	X30Cr13
Semi-ferritic-ferritic	X8Cr17
Soft martensitic	X5CrNi13-4
Ferritic-austenitic	X2CrNiMoN22-5
Austenitic	
Austenite with ferrite	X5CrNi18-9
Austenite without ferrite	X8CrNiNb16-13

These steel groups differ both from the metallurgical and the physical point of view, and suitable measures must be taken when welding to allow for their special features.



## 8.8 Martensitic Cr-Ni(-Mo) steels

A few characteristic martensitic Cr steels and their suitability for welding:

Material designation	%C	%Cr	%Mo	Welding suitability
X12Cr13	0,15	13,0	-	limited
X20Cr13	0,20	13,0	-	very limited
X39CrMo17-1	0,42	16,5	1,2	none

Basically this group of steels must be considered as having only limited suitability for welding. As the carbon content rises, the risk of cold cracking increases, and joint welding should be avoided as far as possible.

The most important alloying element is chromium which, when the content is about 12%, lends its passivity, and therefore its corrosion resistance in oxidising media, to the steels. As a ferrite-forming element, chromium restricts the austenite region of the iron; with about 13% chromium it is entirely choked off. Steels with chromium contents of greater than 13% and with very low carbon contents (< 0.1%) do not undergo any conversion as they cool from the solidification temperature to room temperature. These are the ferritic Cr steels.

The group of hardenable steels begins at chromium contents above 12% and carbon contents of about 0.1 to 1.2%. These are the martensitic chromium steels. As a result of the higher-carbon content, the austenite region is extended, and this creates the possibility of hardening.

28

### Welding martensitic chromium steels

The austenitic component in the heat affected zone of the base material is always converted to martensite with air cooling, since the formation of pearlite and intermediate phases is heavily delayed by the high chromium content.

Due to the high chromium content of the steel, the conversion to pearlite, in which the delta-ferrite and the carbide are precipitated from the gamma solid solutions, only begins after a very long time. As a result, the weld metal, and the heat affected zone (HAZ), effectively always convert to the martensitic phase, unless it is heated above the martensite conversion temperature.

If we consider the increasing hardness of this kind of steel in relation to the carbon content, their unfavourable or inadequate suitability for welding can easily be understood.

Increase in hardness for various carbon contents:

Carbon content	H
0.10% C	ca. 40 HRC
0.15% C	ca. 46 HRC
0.20% C	ca. 50 HRC
0.25% C	ca. 53 HRC
0.40% C	ca. 56 HRC
0.70% C	ca. 58 HRC
1.00% C	ca. 60 HRC

At the same time we can also understand that, in practice, martensitic Cr steels with less than 0.15% carbon are almost the only ones used for welded constructions.

The role played by hydrogen during welding represents a further disadvantageous factor. Particularly when brittle martensite is present, higher hydrogen contents can lead to a strong tendency to hydrogen-induced cold cracking in the welded joint.

## 8.8 Martensitic Cr-Ni(-Mo) steels

Because the martensite is relatively hard, brittle and at the same time susceptible to corrosion, the 13% Cr steels are always quenched and tempered, while 17% Cr steels are quenched and tempered or soft annealed.

This group of steels is welded using both same type and dissimilar welding consumables. See further below for recommendations about the appropriate welding technology and welding consumables.

When same type or similar type welding consumables are used, the weld metal, in the welded condition, consists of martensite and delta-ferrite, with a small proportion of residual austenite. For this reason the figures for elongation and impact energy are very low, and annealing is almost always done at between 700 and 750°C.

### Welding technology

for steels with carbon contents below 0.15%

Covered electrodes and SAW flux are to be redried according to the manufacturer's specifications. Same type welding consumables should only be used when there is a requirement for colour matching, comparable strength or fatigue strength. Otherwise use austenitic welding consumables.

A preheating and interpass temperature of 200 - 300°C is strictly recommended.

After welding, tempering at 700 - 750°C is to be carried out. Pay attention when using austenitic welding consumables – there is a risk of embrittlement.

Suitable welding consumables include:

Microstructure	Designation
Same Type	BÖHLER SKWAM-IG
Dissimilar	BÖHLER FOX A 7, BÖHLER A 7-IG, BÖHLER A 7 CN-UP, BÖHLER A 7-MC, BÖHLER A 7-FD, Thermanit X (SMAW, GMAW, SAW)

## 8.9 Ferritic Cr-Ni(-Mo) steels

The following table contains the chemical composition and the suitability for welding of a number of ferritic Cr steels characterised by a low carbon content. As a result, these steels are predominantly ferritic from the beginning of solidification down to room temperature. They therefore do not undergo any conversion, and for that reason can also not be hardened. In some cases Mo, Ti or Nb are added to the alloy in order to improve the chemical properties.

Material designation	%C	%Cr	%Mo	Welding suitability
X6Cr13	<0,08	13,0	-	limited
X6Cr17	<0,08	17,0	-	limited
X6CrMo17-1	<0,08	17,0	1,1	limited

A fine-grained structure is a precondition for adequate technical parameters, particularly where elongation is concerned. This is achieved if the last conversion stages are carried out below 800°C, with subsequent heat treatment up to 800°C followed by fast cooling in air or water. This group of materials is very sensitive to overheating. If exposed to temperatures above 1000°C, the grains tend to become coarser and this, in combination with carbide precipitation, can result in heavy embrittlement. Ferritic Cr steels are therefore also not used for the construction of pressure vessels.

In addition, the ferritic Cr or Cr-Mo steels tend, as the Cr content rises, to exhibit a time-dependent hardening phenomenon in the temperature range between 400 and 525°C. This is known as 475°C embrittlement. It involves a separation of the ferrite into a high-chromium and a high-iron phase.

### Welding ferritic Cr steels

Particularly in the case of steels with a high Cr content, the heat introduced during welding causes grain growth in the highly heated part of the transition zone, and this cannot be rectified by subsequent heat treatment. In addition, carbide is precipitated at the grain boundaries, leading to a further reduction of toughness. For these reasons, the ferritic Cr steels are classified as having only „limited suitability for welding“. Similarly unfavourable conditions are to be expected in the weld metal when same type welding consumables are used.

The loss of toughness constitutes an absolute weakening of the welded joint. The use of austenitic welding consumables is therefore recommended for welding ferritic Cr steels.

Due to its altogether greater toughness, the austenitic weld metal is able to act to some extent as an expansion element. The austenitic weld metal also offers advantages from the point of view of corrosion chemistry. There is a disadvantage in the form of the different colouring of the base material and the weld metal. If colour matching is a necessity, same type alloy welding consumables must be used. If gases containing high amounts of sulphur or carburising gases will be present in practice, it is possible that the austenitic weld metal will be attacked preferentially (e.g. through the formation of nickel sulphide). In this case, the procedure is to fill the joint with austenitic metal, and to weld only the last layers of the medium exposed surfaces using ferritic welding consumables. Welding is carried out after preheating to between 200 and 300°C, in order to keep thermal stresses as low as possible. Care is to be taken to introduce as little heat as possible, in order to minimise the formation of coarse grains. Annealing in the range from 700 to 750°C is advantageous after welding. This causes the precipitated carbides to coagulate, whilst reducing tensions at the same time. Up to a point, both of these factors bring an improvement in toughness.

The coarse grains in the heat affected zone can not, however, be overcome. When austenitic welding consumables are used, it is necessary to allow for their tendency to precipitate intermetallic phases (embrittlement) in the temperature range between 600 and 900°C.

## 8.9 Ferritic Cr-Ni(-Mo) steels

### Welding technology

for ferritic Cr steels with carbon contents below 0.12%

Covered electrodes and SAW flux are to be redried according to the manufacturer's specifications. Same type welding consumables are only to be used if colour matching is required or if the component will be exposed to sulphurous or carburising gases.

A preheating and interpass temperature of 200 - 300°C is advisable.

The energy input per unit length when welding must be kept as low as possible.

After welding, tempering at 700 - 750°C is recommended. Pay attention when using austenitic welding consumables – there is a risk of embrittlement.

The following table shows suitable dissimilar welding consumables. Types for the same microstructure are available on demand.

Microstructure	Designation
Dissimilar	FOX SAS 2, SAS 2-IG, SAS 2-UP, SAS 2-FD, SAS 2 PW-FD, Avesta 347/MVNB
	FOX EAS 2, EAS 2-IG, EAS 2-UP, EAS 2-FD, EAS 2 PW-FD, Avesta 308L/MVR, Thermanit JEW 308L-17
	FOX CN 23/12, CN 23/12-IG, CN 23/12-UP, CN 23/12-FD, CN 23/12 PW-FD, Avesta 309L

## 8.10 Soft martensitic Cr-Ni(-Mo) steels

Steels with a soft martensitic microstructure have a wide range of applications. The steel type with 12% chromium and 4% nickel is the most important representative of this group of steels. Information on chemical composition and suitability for welding is contained in the following table.

Material designation	%C	%Cr	%Mo	%Ni	Welding suitability
X5CrNi13-1	<0,05	13,0	0-0,4	1 - 1,2	good
X5CrNi13-4	<0,05	13,0	0,4	4,0	good
X5CrNi13-6	<0,05	13,0	0,4	6,0	good
X5CrNi16-6	<0,05	16,0	-	6,0	good/ limited
X5CrNiMo16-5-1	<0,05	16,0	1,5	5,0	good/ limited

This kind of material exhibits a very wide range of mechanical properties, depending on its chemical composition and, above all, on the type of heat treatment. For this reason, only the X5CrNi13-4 type will be considered closely in what follows.

The basic ideas behind the development were, firstly, to lower the carbon content in order to increase the toughness of the martensitic structure and to reduce the tendency to cold cracking, whilst achieving a microstructure as free as possible from delta-ferrite by alloying with between 4 and 6% nickel.

At „room temperature“ the microstructure thus consists of „soft“ martensite with small quantities of supercooled delta-ferrite and austenite. Tempering further increases the toughness and lowers the hardness or strength. At the same time, the low carbon content and the inclusion of about 0.5% molybdenum in the alloy increase the corrosion resistance.

A significant advantage of the soft martensitic chromium-nickel steels lies in their good suitability for welding when compared with plain chromium steels.

The suitability of the soft martensitic steels for welding is largely characterised by three properties, namely:

1. The formation of low-carbon, tough martensite in the HAZ and in the weld metal, so greatly reducing the tendency to cold cracking.
2. A low delta-ferrite content. To a large extent this counters the tendency to form coarse grains when welding.
3. The sensitivity of the martensitic microstructure to hydrogen. Hydrogen-induced cold cracking can occur if the content of diffusible hydrogen is > 5 ml / 100 g.

### Welding soft martensitic Cr-Ni steels

The type of heat treatment applied has an important effect on the mechanical properties of these materials. Soft martensite with a nickel content of more than 3.5% exhibits a special metallurgical behaviour, namely the formation of finely dispersed austenite at tempering temperatures above 580°C. This effect results in an increase of the values for impact energy in the 13/4 weld metal. The highest values are achieved through tempering at between 600 and 620°C. At higher tempering temperatures, the impact energy falls again due to the conversion of the tempered austenite into martensite as it cools.

## 8.10 Soft martensitic Cr-Ni(-Mo) steels

The selection of the interpass temperature is of special importance if cold cracking is to be avoided in the welded joint. Practical experience of soft martensitic materials indicates that a sudden „flipping“ of large regions of the welded seam into martensite should be avoided when cooling after welding. Otherwise, extremely high conversion stress and internal stress conditions must be expected in the weld metal, and these can later result in cold cracking. Interpass temperatures that lie close to the Ms temperature must therefore be considered critical.

It is recommended that the interpass temperature should be kept in the range between 120 and 220°C for the X5CrNi13-1 weld metal, and between 100 and 160°C for the X5CrNi13-4 and X5CrNi13-6 weld metals.

As a result, a martensite conversion of about 50% occurs in the weld bead, which is advantageous from the metallurgical point of view and from the point of view of stress. Accurately maintaining the quoted interpass temperature is of particular importance when it is not possible to carry out a subsequent heat treatment.

### **Welding technology**

In the light of the special features of welding soft martensitic steels, it is recommended that the welding technique described below is followed. These notes apply to the most important soft martensitic steel, containing 13% Cr and 4% Ni.

1. Only same type alloy welding consumables should be used for joining.
2. Covered electrodes and SAW flux are to be redried in accordance with the manufacturer's specifications in order to maintain a hydrogen content of < 5 ml/100 g in the weld metal.
3. Thick walled components should be preheated to 100°C, and welded using an interpass temperature in the range between 100 and 160°C.
4. Tempering, or quenching and tempering is required after welding in order to increase toughness.

## 8.11 Austenitic Cr-Ni(-Mo) steels

The group of austenitic chromium-nickel-(molybdenum) steels is the most significant of these stainless materials. Generally speaking, these chemically resistant steels can be classified as „very well suited to welding“. They cannot be quench hardened, which means that hardening does not occur in the heat affected zone, and there is no significant grain coarsening. Nevertheless, unsuitable handling can, in some circumstances, cause three problems, both in the base material and in the weld metal. These are:

Sensitisation, i.e. a reduction in the resistance to corrosion due to the formation of chromium carbide.

Hot cracking, i.e. separation of grain boundaries during solidification, or in the highly heated HAZ when rigidly fixed.

Embrittlement, i.e. the precipitation of intermetallic phases such as the sigma phase through exposure to high temperatures or annealing.

When welding the fully austenitic steels, their inherent tendency to hot cracking must also be considered. Notes on the welding techniques for standard austenitic Cr-Ni(-Mo) steels, the subsequent heat treatment of the weld seams, and information on welding consumables can be found in the corresponding sections.

### Welding technology

34

Only grades corresponding to the base material concerned should be used for welding. The delta-ferrite content of the weld metal should be in the range between 3 - 15 FN (ferrite number). This ensures sufficient resistance to hot cracking. For highly corrosion-resistant special steels, same type welding consumables that yield a fully austenitic weld metal are also available.

Ensure that austenitic steels are only processed when their surface is clean and dry.

The arc should be kept as short as possible in order to avoid picking up nitrogen from the air. When welding with shielding gas, it is necessary to make sure that the gas shield is working perfectly. With the exception of flux cored wire welding, only shielding gases with a low CO<sub>2</sub> content should be used in order to keep carburising of the weld metal to the lowest possible level.

Preheating to 100 - 150°C is only advisable if the base material is thick, but it is not necessary in principle.

An interpass temperature of 150°C should not be exceeded.

Ensure that the current intensity is kept within the recommended range.

If it is not possible to reweld the root when welding with shielding gas then shielding gas (e.g. forming gas or pure argon) must be applied from the rear when welding the root.

If possible, dilution with the base material should be kept below 35%. If, as a result of the welding method, it is higher than this, the ferrite content of a test seam must be determined with a calibrated ferrite content meter or an estimate must be calculated from the chemical composition, e.g. using the WRC-92 diagram. The ferrite content, i.e. the FN, should not be below the minimum figure mentioned above.

Annealing treatment after welding should be avoided at all costs. If this is not possible, then it must be expected that the corrosion resistance and/or toughness may be impaired. In such cases consultation with the manufacturer of the steel and of the welding consumable is recommended.

In general it is possible to use unstabilised, low-carbon welding consumables for stabilised steels and vice versa, but the limit temperature for intergranular corrosion must be borne in mind.

Greater distortion than when welding ferritic steels must be allowed for, and corresponding countermeasures, such as the seam shape, stronger tacking, pre-stressing, back-welding and so forth must be considered.

## 8.11 Austenitic Cr-Ni(-Mo) steels

Straightening with the gas flame should not be done if at all possible, as corrosion resistance can suffer from this. The harmful effect of arc strikes outside the welded joints should also be particularly stressed in this context.

Only slag hammers and brushes of stainless Cr or Cr-Ni steels should be used for cleaning austenitic welded joints.

It must be stressed that an entirely clean metal surface is a precondition for optimum corrosion resistance. It is not only necessary to remove all the welding scales, the slag and spatter, but all the annealing colours must also be eliminated.

Subsequent treatment can comprise grinding, pickling, blasting with quartz, corundum or glass beads, brushing and/or polishing. The finer the surface, the better is the corrosion resistance (e.g. rough grinding – fine grinding – polishing).

Pickling is used most often. A variety of pickling solutions or pastes are available for this purpose. They are applied to the surface, and after the recommended exposure time must be thoroughly rinsed with water. Removing the „annealing colours“ from welded seams can be a problem. These too can be removed by washing with quartz sand or by brushing.

If the pickled component will soon be exposed to corrosive agents, as is frequently true for repair jobs, then passivation is recommended after the pickling. Thorough rinsing is again necessary after the passivation treatment. While we are talking about the application of pickling agents, it is important to stress that these are highly caustic substances. It is therefore essential that protective gear such as rubber gloves, rubber aprons, eye protection and possibly breathing protection are used. Local environmental protection regulations must also be observed.

Blasting with quartz, corundum or glass beads is used when grinding or pickling are ruled out. This method must only be applied using the said materials. The method does yield a clean, metallic surface, but one that is somewhat rough. Passivation should also be carried out after blasting.

The following table provides examples of various Böhler welding consumables that are appropriate for welding the materials under discussion:

Material	Designation
X5CrNi18-9	BÖHLER FOX EAS 2-A (IG/UP/FD), Thermanit JEW 308L-17, Avesta 308L/MVR
X2CrNi18-9	BÖHLER FOX EAS 2-A (IG/UP/FD), Thermanit JEW 308L-17, Avesta 308L/MVR
X5CrNiMo18-12	BÖHLER FOX EAS 4 M-A (IG/UP/FD), Thermanit JEW 316L-17, Avesta 316L/MVR
X2CrNiMo18-10	BÖHLER FOX EAS 4 M-A (IG/UP/FD), Thermanit JEW 316L-17, Avesta 316L/MVR
X10CrNiNb18-9	BÖHLER FOX SAS 2-A (IG/UP/FD), Thermanit H Si, Avesta 347/MVNB
X10CrNiMoNb18-10	BÖHLER FOX SAS 4-A (IG/UP/FD), Thermanit AW, Avesta 318-Si/SKNb-Si



## 8.12 Determining the ferrite content of the weld metal

The austenitic, chemically resistant Cr-Ni steels are generally well-suited to welding. Nevertheless, the special physical properties of these steels – low thermal conductivity and high coefficient of thermal expansion – must be considered when welding, as they are relevant to heat control. The type of primary solidification is particularly important to these materials, and later has a significant effect on the hot cracking behaviour.

For the welding practitioner, the presence of a certain proportion of ferrite in the weld metal is an indirect indication of adequate resistance to hot cracking. Ferrite in the weld metal is generally favourable for welded seams that are not able to expand freely, when the cross-section of the weld seam is large, and when cracks have already impaired the suitability for use. Ferrite increases the strength of the weld metal, but has a disadvantageous effect on the resistance to corrosion in certain media. It is also unhelpful for low-temperature applications, and in the high temperature range where conversion to the brittle sigma phase is possible.

In addition to metallurgical estimation, the ferrite content can be determined magnetically or through calculation. The scale used is not absolute, which means that it can be expected that measurements from different laboratories give different results (e.g. results scattered between 3.5 and 8.0% for a sample with about 5% of delta-ferrite). The measurements are usually reported in FN (ferrite numbers). Up to about 10 FN the ferrite number can be equated to the percentage of ferrite.

It is the opinion of the Welding Research Council (WRC) that it is not at present possible to determine the absolute ferrite content of austenitic-ferritic weld metals. Scatter can also be expected from samples with pure weld metal, resulting from variations in the welding and measurement conditions. The usual standardisation assumes a 2 sigma scattering, which implies a variation of  $\pm 2.2$  FN for an FN 8. Greater scatter can be expected if the welding technique permits a high uptake of nitrogen from the surrounding air. A high nitrogen pickup can have the result that a weld metal with 8 FN can fall to 0 FN. A nitrogen pickup of 0.10% typically lowers the ferrite content by 8 FN. Dilution with the base material results in weld metals whose ferrite content has been lowered further, since the same type base materials usually have lower ferrite contents than the pure weld metal.

As an alternative to measurement, the ferrite content can also be calculated from the chemical composition of the pure weld metal. A variety of microstructure diagrams can be employed for this purpose. These include the WRC-92 diagram, the Schaeffler diagram, the DeLong diagram and the Espy diagram. The results obtained from the individual diagrams can vary strongly, since they have been prepared on the basis of series investigations for a variety of materials groups.

The WRC-92 diagram provides a prediction of the ferrite content, expressed in FN. It is the most recent of the listed diagrams, and has shown better agreement between the measured and estimated ferrite contents than when the DeLong diagram is used. It should be noted that the WRC-92 diagram does not consider the silicon or manganese content, which means that its applicability to high-silicon and high-manganese (more than 8%) weld metals is limited. In addition, if the nitrogen content is more than 0.2%, it is again of limited applicability.

The Schaeffler diagram is the oldest of the listed diagrams, and in the past has been widely used for the calculation of ferrite content. It can be applied over a wide range, but does not take account of the strong austenitising effect of nitrogen.

The Espy diagram attempts to compensate for these weaknesses. Like the Schaeffler diagram, it calculates the ferrite content in percent, but does handle manganese contents of up to 15% and nitrogen contents of up to about 0.35%.

The DeLong diagram is a modification of the Schaeffler diagram, expressing the ferrite content in ferrite numbers up to about 18 FN. The diagram does take the nitrogen content into account, and provides better agreement between measurement and calculation than the Schaeffler diagram. Its applicable range is quite similar to that of the WRC-92 diagram.

## 8.12 Determining the ferrite content of the weld metal

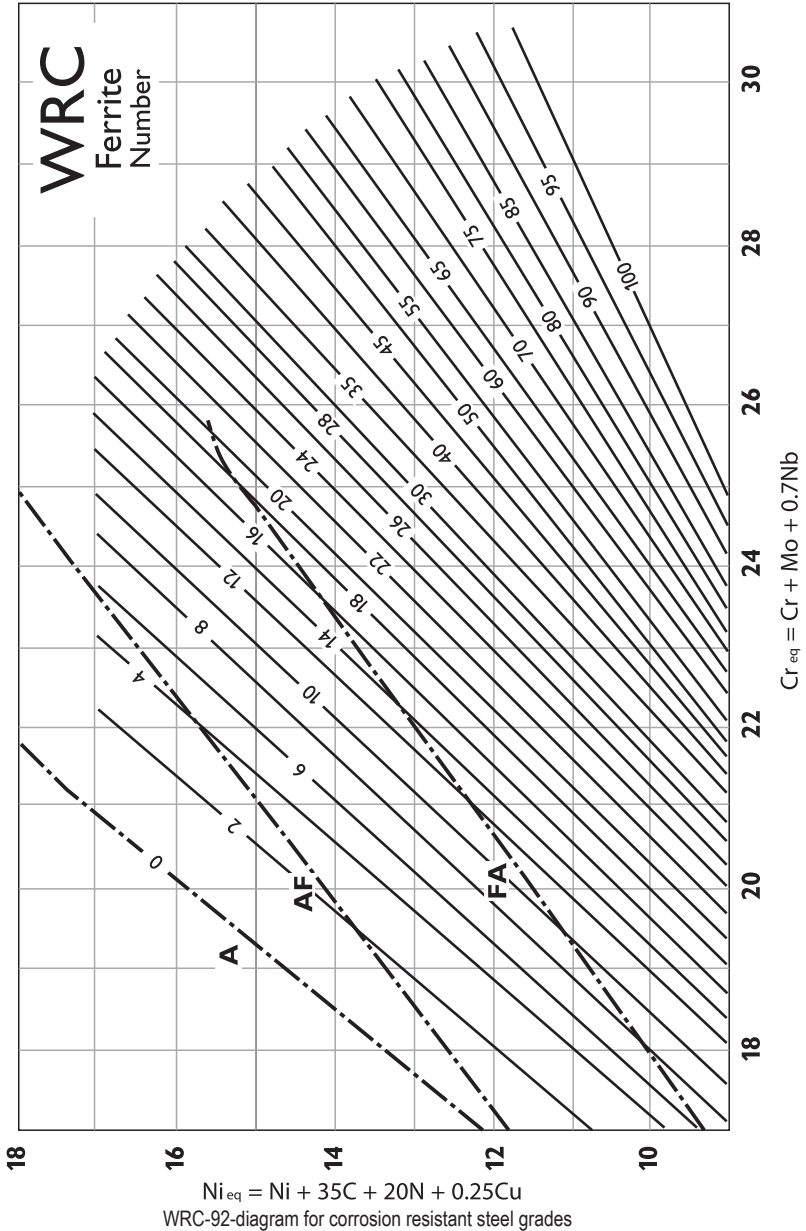

## 8.12 Determining the ferrite content of the weld metal

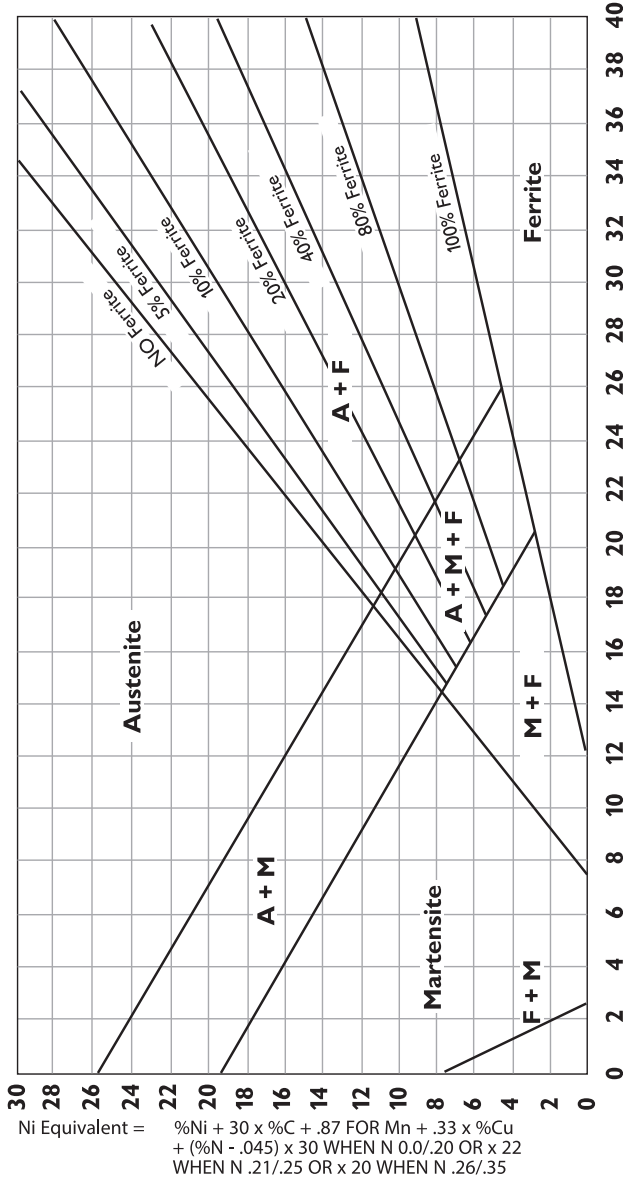

$$\text{Chromium Equivalent} = \%Cr + \%Mo + 1.5 \times \%Si + 0.5 \times \%Cb (Nb) + 5 \times \%V + 3 \times \%Al$$

ESPY diagram for determining the ferrite content of corrosion resistant steels

## 8.12 Determining the ferrite content of the weld metal

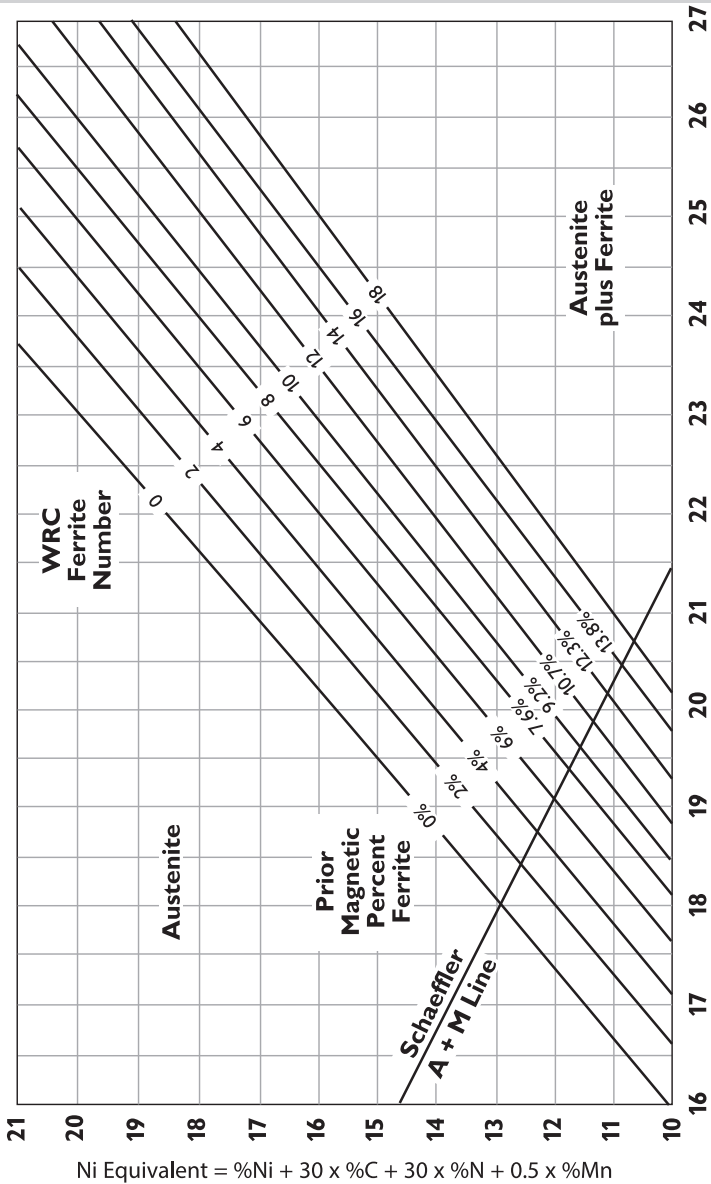

$$\text{Chromium Equivalent} = \%Cr + \%Mo + 1.5 \times \%Si + 0.5 \times \%Cb$$

DeLong diagram for determining the ferrite content of corrosion resistant steels

## 8.12. Determining the ferrite content of the weld metal

If the nitrogen content is not known for determining the nickel equivalent, then a content of 0.06% can be assumed for TIG welding and for manual electrode welding, or 0.08% for gas shielded arc welding with solid wire electrodes. The ferrite number can be predicted using the WRC-92 diagram – assuming that the chemical composition is correct – over a range of  $\pm 3$  FN in about 90% of measurements.

### The effect of delta-ferrite

The following summary covers the advantages and disadvantages of delta-ferrite in an austenitic weld metal. Basically, the comments also apply to the steel material. Depending on the conditions of practical use, delta-ferrite may sometimes be unwanted, but is advantageous in the majority of cases and sometimes even required. The reasons for what at first may appear to be conflicting requirements are provided in the summary. The consequences of deviating from it are also indicated.

Reasons	Consequences of too much or too little
Low delta-ferrite content is unwanted Requirement for non-magnetic weld metal FN=0 Particular corrosion stress FN 0.5 Use at very low temperatures FN 0.5 Use at very high temperatures FN 0.5	Magnetisability Selective corrosion Loss of toughness Phase precipitation
Too low delta-ferrite proportion is advantageous High resistance hot cracking, including thick-walled components Usage temperatures between -100 and 400 C FN=3-15 No unusual chemical stress	Risk of hot cracking FN 3 Loss of toughness FN 15 Phase precipitation FN 15 Selective corrosion FN 15
High delta-ferrite content is required Resistance to stress corrosion cracking FN=30-75 Increase in strength FN=30-75 Compensation for the dilution when welding dissimilar joints FN=15-25	Reduced resistance to stress corrosion cracking FN 30 Reduced toughness FN 75 Reduced strength FN 30 Risk of hot cracking from dilution FN 15

## 8.13. Heat-resistant steels

Steels that feature particular resistance to scaling caused by gases at temperatures above around 600°C are classified as heat-resistant. A steel is classed as heat-resistant if, at a temperature  $x$ , the weight of the metal that turns to scale at this temperature does not, on average, exceed  $g/m^2 \cdot h$ , and does not exceed  $2 g/m^2 \cdot h$  at a temperature of  $(x + 50^\circ C)$ , when stressed for 120 hours with four intermediate coolings.

Information and notes on the resistance to scaling and/or to the highest application temperatures is contained in, for example, SEW 470, but this must only be used as a guide. Under unfavourable conditions, e.g. in sulphurous or reducing gases, particularly when the water vapour content is high or when there is a possibility that aggressive dust may be deposited, the range of temperatures for application is lower. On top of this, the possibility of sigma phase precipitation must be considered. The important groups of heat-resistant steels are listed in the following table. They are divided according to the microstructure.

Microstructure	Typical examples
Ferritic	X10CrAlSi7, X10CrAlSi13, X10CrAlSi25
Ferritic-austenitic	X20CrNiSi25-4
Austenitic	X12CrNiTi18-9, X15CrNiSi25-21, X12NiCrSi36-16

Depending on the conditions of the practical application, ferritic chromium steels may be joined using same type alloys, or, predominantly, using austenitic welding consumables. Preheating and interpass temperatures in the range between 200 and 300°C are recommended for thicker cross sections. Subsequently, the toughness properties impaired by the formation of coarse grains and by carbide precipitation can be improved through a heat treatment at between 700 and 750°C.

The steels with a ferritic-austenitic microstructure are usually welded using same type welding consumables, without preheating or subsequent heat treatment.

With fully austenitic chromium-nickel steels and welding consumables, their inherent tendency to hot cracking must be borne in mind. In the temperature range between 600 and 900°C, the possibility of embrittlement through the precipitation of intermetallic phases must be considered.

Both same type alloy welding consumables and nickel-based welding consumables are sometimes used.

## 8.14 Welding dissimilar joints

The number of possible dissimilar joints between the very different kinds of steel is so enormous that it is practically impossible to record every single combination of materials. For this reason, there are only a few associated standards or sets of regulations.

Basic general rules in the form of notes, recommendations and precautionary measures for the selection of welding consumables and the development of suitable welding techniques are therefore listed below. These basic rules, however, are only helpful if their practical implementation is done with enough technical expertise and enough fundamental metallurgical knowledge.

When joining different materials, there are many cases in which it is not possible to select the optimum welding consumable and welding conditions for both individual materials. Suitable compromises must therefore be found.

The selection of the suitable welding consumable is an important criterion for welding dissimilar joints. The consumable must be chosen in such a way that no excessively hard, brittle or easily cracked weld metal is created when it becomes diluted with the different base materials. General notes and recommendations for the selection of welding consumables for dissimilar joints are given below. It must be borne in mind here that a large number of different factors are relevant to the selection of suitable welding consumables, and not all of these can be covered in this chapter. For this reason, the manufacturer and designer should be consulted over the selection of welding consumables.

### **Unalloyed – unalloyed**

(e.g. S235JR with S355J2)

Unalloyed types of steel with different strengths are often joined together in practice. The mechanical properties of the base materials are the main things to be considered in the case of such joints. As a rule, welding consumables whose strength corresponds to the softer base material are used. It must, however, be noted that, due to the fine-grained structure, unalloyed weld metals rarely fall below 0.2-off-set yield strengths of 400 MPa.

The choice between coating, filling and flux types is made in the light of the welding method, bearing in mind the wall thickness and the component stiffness. At higher strengths, or when a component will be subjected to stress, the use of basic welding consumables or auxiliary materials is to be recommended. Their metallurgically pure weld metal, associated with low hydrogen contents, ensures good resistance to cracking.

### **Unalloyed – creep resistant**

(e.g. P235GH with 13CrMo4-5)

For these joints a welding consumable of a similar type to the lower-alloy material is used as a rule. If subsequent heat treatment is required, the annealing temperature must be appropriate for the two base materials and for the welding consumable.

### **Unalloyed – high-strength**

(e.g. S235JR with S460N)

The welding consumables are usually matched to the softer base material. If the strengths of the two materials are very different (e.g. S235JR with S690Q), the welding consumables should have strengths between the values for the two base materials. Welding technique should be matched to the higher-strength base material.

## 8.14 Welding dissimilar joints

### Unalloyed – cryogenic

(e.g. S235JR with 15NiMn6)

With low-temperature steels containing up to 3.5% Ni, unalloyed welding consumables can be used, as well as welding consumables of the same or similar alloy to the material that contains Ni. If the Ni content is between 5 and 9%, austenitic or nickel-based welding consumables should be used.

### Unalloyed – quenched and tempered steels

(e.g. S235JR with 42CrMo4)

Quenched and tempered steels only offer limited suitability for welding. The steels must be preheated, and must be subjected to subsequent heat treatment.

Either unalloyed or alloyed welding consumables may be considered, depending on the pair of base materials. Dilution should be kept to a low level.

In special cases, nickel-based welding consumables may also be used. In exceptional cases in which subsequent heat treatment is not possible, the use of over-alloyed austenitic Cr-Ni welding consumables (e.g. BÖHLER A 7 CN-IG) may be advantageous.

### Unalloyed – chrome steels

(e.g. S235JR with X12Cr13)

Both ferritic and martensitic Cr steels require special heat control when welding, and subsequent annealing. For this reason, the use of nickel-based alloys (depending on the conditions of use) is to be recommended. If subsequent annealing is not possible, and if the operating temperature is limited to a maximum of 400°C, then austenitic over-alloyed welding consumables may also be used.

### Unalloyed – austenite

(e.g. S235JR with X5CrNi18-10)

A complex metallurgical problem is presented when steels with very different chemical compositions are to be joined, and it can only be solved through compromise. In general, over-alloyed austenitic welding consumables are to be used.

The selection of the welding consumable is of crucial importance for this type of dissimilar joint. Bearing in mind the dilution with the different base materials, a weld metal having neither a martensitic microstructure, nor an austenitic-ferritic microstructure containing 0 to 5%  $\delta$ -ferrite should be formed. In this way a crack-free, tough welded joint between the unalloyed steel and the austenitic material is ensured. The dilution between the base materials and the welding consumable should here be kept as low as possible. The Schäßler diagram can help to select the welding consumables.

If the welding is to be carried out under circumstances that are subject to acceptance tests, a nickel-based consumable material should be used if subsequent heat treatment is carried out, if the operating temperature is above 300°C, or if the walls that are to be welded are thicker than 30 mm.

### High-strength – high-strength

(e.g. S460N with S890Q)

For dissimilar joints of high-strength fine-grained structural steels, the selection of the strength of the welding consumable should be oriented around the softer steel type.

If the strength characteristics of the two materials are very different (e.g. S460N with S890Q), a welding consumable with a strength between that of the base materials is to be used. Otherwise a weak point will be created in the component as a result of the large step in strength in the region of the welded joint. Welding technique should be matched to the higher-strength base material.



## 8.14 Welding dissimilar joints

### High-strength – austenite

(e.g. S460N with X5CrNi18-10)

As is the case of joints between unalloyed steel and austenite, over-alloyed austenitic welding consumables are to be used.

If the welding is to be carried out under circumstances that are subject to acceptance tests, a nickel-based consumable material should be used if subsequent heat treatment is carried out, if the operating temperature is above 300°C, or if the walls that are to be welded are thicker than 30 mm.

### Cryogenic – cryogenic

(e.g. S275NL with 15NiMn6)

The welding consumables are to be selected bearing in mind the necessary low-temperature toughness. For dissimilar joints on steels with up to 3.5% Ni, a welding consumable that matches one of the two materials is adequate. If the Ni content is between 5 and 9%, austenitic or nickel-based welding consumables should be used.

### Cryogenic – austenite

(e.g. 15NiMn6 with X5CrNi18-10)

The welding consumables are to be selected bearing in mind the necessary low-temperature toughness. Over-alloyed fully austenitic welding consumables should mainly be considered.

### Creep resistant – creep resistant

(e.g. 16Mo3 with 13CrMo4-5)

For these joints a welding consumable of a similar type to the lower-alloy material is used as a rule. The subsequent heat treatment must be appropriate for both the base materials and for the welding consumable. For the construction of steam boilers, the associations have provided, in Agreement 2003/3 (Steam Boilers), binding rules for the selection of welding consumables and annealing temperatures.

### Creep resistant – austenite

(e.g. 13CrMo4-5 with X5CrNi18-10)

Nickel-based welding consumables are mostly used for these joints, since the majority of creep-resistant steels need to be strongly preheated and subjected to heat treatment. Since many austenitic steels tend to exhibit  $\sigma$ -phase embrittlement at temperatures above 400°C, the weld edges of the creep-resistant material should be plated with 3 layers using a nickel-based welding consumable, and then annealed. Only then should the joint be welded. Only in exceptional cases can over-alloyed austenitic welding consumables also be used.

### Quenched and tempered steels – quenched and tempered steels

(e.g. 25CrMo4 with 42CrMo4)

Quenched and tempered steels only offer limited suitability for welding. Their suitability for welding falls as the C content rises. They require special heat control while welding, as well as subsequent annealing. Same-type welding consumables scarcely exist. The selection is made in accordance with the given strength, bearing in mind the necessary heat treatment. In many cases the conditions of practical application permit the use of softer welding consumables. Nickel-based welding consumables can also be used.

Only in those cases where no subsequent heat treatment will be carried out should the use of overalloyed austenitic Cr-Ni welding consumables be considered.

## 8.14 Welding dissimilar joints

### **Quenched and tempered steels – austenite**

(e.g. 42CrMo4 with X5CrNi18-10)

The restricted suitability for welding, as well as the necessary subsequent heat treatment, mean that nickel-based welding consumables must be used, that the welding edges of the quenched and tempered steel are plated with 3 layers, and that annealing is carried out afterwards. Only when no heat treatment is carried out can over-alloyed austenitic welding consumables be used; in this case an operating temperature of at most 400°C should not be exceeded.

### **Austenite – austenite**

(e.g. X5CrNi18-10 with X6CrNiMoTi17-12-2)

The welding consumable should be selected to match the chemical composition of the higher-alloy material.

### **Austenite – chrome steels**

(e.g. X5CrNi18-10 with X12Cr13)

The selection of the welding consumable depends on the operating conditions. Both ferritic and martensitic Cr steels have only limited suitability for welding. For this reason, special heat control during welding and subsequent heat treatment are required. It is therefore necessary to take account of the tendency to embrittlement when specifying austenitic welding consumables. In some cases this can require the use of nickel-based welding consumables.

### **Austenite – heat-resistant**

(e.g. X5CrNi18-10 with X8CrNi25-21)

Welding consumables whose alloy corresponds to that of the heat-resistant material, should mainly be used.

### **Nickel-based – nickel-based**

(e.g. Alloy C 625 with Alloy C 22)

The choice of welding consumable must be considered separately for every pair of materials.

### **Nickel-based – unalloyed / creep resistant / high-strength / cryogenic / quenched and tempered steel**

(e.g. C 276 with S235JRG1 / 13CrMo4-5 / S460N / 14Ni6 / 24CrMo4)

A range of differently alloyed nickel-based welding consumables is available for these kinds of dissimilar joints. In many cases a welding consumable with the same type or similar type alloy to the nickel-based base material is used.

### **Nickel-based – chromium steel / austenite / heat-resistant**

(e.g. C 276 with X12Cr13 / X5CrNi18-10 / X8CrNi25-21)

The conditions in which the weld will be used must be considered when choosing the welding consumable. Usually a welding consumable with an alloy of the same or similar type as the nickel-based alloy is used.

### **Hard manganese steel – unalloyed**

(e.g. X120Mn12 with S235JRG1)

The use of austenitic Cr-Ni welding consumables with an increased Mn content, or over alloyed types, is recommended.

### **Hard manganese steel – austenite**

(e.g. X120Mn12 with X5CrNi18-10)

Austenitic types with an increased Mn content, or over alloyed types, are recommended as the welding consumable.



## 9.0 Welding technology oriented considerations

### Overview

A correct welding technique is an important precondition for the fabrication of welded joints that meet their requirements. This section will not go into every facet of the question, but a number of points will be selected that are often the subject of enquiries from welding engineers. A more comprehensive treatment of this material would go far beyond the scope of this manual.

## 9.1 Instructions for preheating materials

### Steel hardening during welding

Due to the fact that, during welding, certain regions of the base material in the heat affected zone will always be heated above Ac1 or Ac3, there is a risk that hardenable steels will harden and therefore develop cracks. The tendency of unalloyed and alloyed steels to harden depends in particular on the carbon content, but also on the alloy contents. During welding, the rate of cooling out of the austenite region can be so great that it corresponds very much to hardening in water.

The rate of cooling is greater when  
less heat is introduced during welding,  
the material is thicker,  
the material is colder.

If the critical rate of cooling is reached, the formation of martensite must be expected. The magnitude of the hardness figure depends largely on the carbon content.

The hardness rises linearly as the carbon content rises up to about 0.45% C, reaching a value of around 650 HV. The impact energy in a hardened steel with up to 0.12% carbon is more than 78 joules, and drops off steeply at higher C-contents. Above 0.2% C it is less than 32 joules. It can be seen from this that the value of 0.2% C is approximately the limit up to which steels can be welded without preheating and without taking special precautions.

48

If the filler and cover passes are welded on top of the root pass, the zones underneath are normalised or tempered, and the peaks of hardness close to the root seam are reduced. However, if cracks have already formed in the transition zone due to the hardening that follows the welding of the root pass, these remain even after the further passes are applied to the welded joint, and in some circumstances can cause the welded component to fracture.

In zones that have been hardened in this way, welding shrinkage leads to high stresses, since the material is prevented from dispersing it through plastic deformation. In addition, particularly when the cross sections are thick, multi-axis stress develops in this region, further encouraged by the fact that the formation of martensite is accompanied by an increase in volume. If the stresses reach the cohesion strength, cracks will occur in the transition region.

Hydrogen can play a large part in the creation of these underbead cracks. In order to have some certainty of avoiding underbead cracks, a hardness value of 350 HV should not be exceeded if at all possible.

In order to avoid underbead cracks, and therefore to guarantee the safety of a welded construction, an accurate knowledge of the hardening processes in the heat affected zone of the steel is, for the reasons mentioned above, of great importance. It also appears very important that, with a given steel having a known chemical composition prior to welding, predictions can be made about the possibility of hardening.

### Preheating the material

The preheating temperature is the temperature to which the workpiece must be brought in the region of the welded joint before welding the first bead.

### Reasons for preheating

The heat introduced into the workpiece during welding, and thus the steepest temperature gradient that occurs in the zone between the weld metal and the unaffected base material, can result in changes in the material (risk of cracking). Preheating reduces the temperature gradient, and ensures slow cooling. This means that the critical cooling rate, which can lead to disadvantageous changes in the microstructure, is not reached (hardening is slight or non-existent – no risk of cracking).

## 9.1 Instructions for preheating materials

In addition, the shallower temperature gradient reduces shrinkage, and fewer distortions therefore occur. The internal stresses caused by welding are reduced, and at the higher temperatures the hydrogen has more time to diffuse out (lower hydrogen content – lower risk of hydrogen-induced cracking).

A steel must always be preheated before welding if there is a risk of critical changes in the microstructure. This applies in particular to tack welding. The necessity of preheating results from the tendency of certain steels to harden in the heat affected zone, as described above. If the welding process happens to be interrupted, the preheating temperature must be achieved again before welding continues. It is, however, a general rule that critical seams in particular are to be welded in one pass – i.e. without interruption.

### Height of the preheating temperature

The optimum preheating temperature depends on a large number of factors. These include: the chemical composition of the base material, the welding procedure, the diameter and type of the welding consumable, the speed of welding, the thickness of the workpiece, the orientation of the welded joint on the component, the possibility of heat dissipation, the nature of the design, the external temperature, and so on. For the structural steels, fine-grained structural steels and creep resistant steels, EN 1011-2 offers ways of calculating and estimating the preheating temperature. This possibility is, however, only available within certain analytical limits. It is also possible to estimate the preheating temperature with the aid of the corresponding time-temperature-transformation curve. The martensite start temperature, and the fields for the bainite stage in the pearlite stage, provide orientation.

### Performing the preheating

Once the preheating temperature has been determined, the area that is to be welded must be appropriately heated. It must be remembered that the heat flows away into the cold material. The heat input must be large enough for the specified temperature to be reached throughout the entire cross-section, i.e. both at the front and the back.

Relatively short seams are usually preheated with the welding torch. Special torches with air intake, or fuel gas/compressed air torches are also used. In addition to preheating in a furnace, inductive preheating or resistance heating are also possibilities. Nowadays the latter two are preferred, since accurate control is possible here, which is essential for many materials. Notes on the size of the zone to be heated, and on measuring the preheating and interpass temperatures, are found in EN ISO 13916.

## 9.2 Instructions for tack welding

In essence, tack welding is subject to the same quality rules as welding itself. This applies both to the heat control (preheating) and to the selection of the welding consumable. In many cases, due to the rapid dissipation of heat, it is advisable to preheat the workpiece even if the base material itself does not normally necessitate preheating. Non-identical welding consumables, generally with lower strength and higher toughness, can be used, depending on the material. These tacking sites then usually have to be ground out at a later stage, and can only be left if a consideration of the design conditions allows it. Tacking sites should always be sufficiently long and thick, in relation to the thickness of the base material, so that they can accept the internal stresses that arise in the course of assembly. Cracked tack welds must always be ground out.

Tack welds used for assembly aids must be removed and ground smooth.

If the materials are sensitive, the ground regions should be checked for freedom from cracks. In austenitic materials, the tacks must be carried out using the same conditions as the welding itself (forming). More tacks are necessary here due to the greater shrinkage.

## 9.3 Instructions for avoiding welding defects

Faults in welded joints are unwelcome, and in some cases can be the cause of very expensive rework. In many cases, faults and damage can be avoided through taking simple precautions. These precautions can be implemented at various stages in design and manufacture. They can range from the optimum selection of welding consumable, can include proper control of the welding process, and regular servicing of the electrical power source. This subsection does not give a complete overview of all possible welding defects, but restricts itself to types of fault that can be avoided through relatively simple precautions. In addition to a description of fault of its causes, the following tables contain possible countermeasures that can have a favourable effect. For more detailed information, standards, welding guidelines (e.g. those of the DVS – the German Welding Society) and other literature can be consulted.

The following list provides explanations of possible adverse effects that can occur when welding steels, and suggests measures for avoiding these faults. Fundamentally, the majority of the effects listed can be avoided by optimising the chemical composition of the steel and of the welding consumable.

The list is not sorted according to the importance of the faults described.

faults and causes	counter-measures
Atomic hydrogen diffuses into the weld metal and into the heat affected zone during welding. This can result in cracking during and after cooling, particularly in regions of higher internal stress and high dislocation density (e.g. at the grain boundaries in martensite).	Use of welding consumables that yield a very low hydrogen content in the weld metal.  Redrying the welding consumable. Preheating the joint.  Application of low-hydrogen annealing straight from welding heat
In general, the toughness of certain parts of the heat affected zone is impaired with respect to the base material through the formation of coarse grains or through hardening. Unfavourable crystallisation in the weld metal can lead to poor figures.	Selection of the optimum welding temperature cycle, layer structure and/or bead geometry.
Solidification cracks are predominantly associated with trace elements such as sulphur or phosphorus. These can precipitate in the centre of the bead during solidification. They are the result of the formation of low-melting films around the grain boundaries. These films reduce the ability of the weld metal to deform, and longitudinal cracks can then develop as a result of the shrinkage stresses as the weld metal solidifies.	Modifying the welding parameters so that the individual beads are broader and flatter, i.e. reducing the depth-width ratio of a bead.  Reducing dilution with the base material.  Lowering the welding speed.  Note: Solidification cracks rarely occur in steels with low sulphur and phosphorus contents.



## 9.3 Instructions for avoiding welding defects

faults and causes	counter-measures
<p><i>R R</i></p> <p>If no special measures are taken during manufacture of the steel, the toughness of flat products or sections can be significantly less in the direction of the thickness than in the longitudinal direction. This is caused by the presence of non-metallic inclusions which are lengthened by the rolling process. Shrinkage stresses in the weld metal that act in the direction of the thickness can cause these inclusions to open, so causing fractures parallel to the surface of the plate.</p> <p>Highly stressed T-butt joints and cruciform joints tend to exhibit this fault.</p>	<p>Use of steels with specified properties in the direction of the thickness.</p> <p>Avoidance of susceptible arrangements of welded seams</p> <p>Preheating</p> <p>Observing DASt Guideline 014</p>
<p><i>R R R</i></p> <p>Carbide or nitride precipitation can occur during stress-relief annealing if the annealing itself and/or the composition of the steel are unfavourable. This can reduce the ability of the steel to deform to such an extent that the stress relief does not just lead to plastic deformation, but also to the formation of cracks.</p>	<p>Reduction of the stress concentration by grinding the weld toes.</p> <p>Reducing the proportion of coarse grains in the heat affected zone through a correct sequence of weld beads.</p> <p>Use of the optimum heat treatment process.</p>
<p><i>RR R</i></p> <p>Differences in the chemical composition, grain size and stress between the weld and the base material can result in different corrosion rates. In the majority of cases it is the weld and the heat affected zone that are preferentially attacked.</p>	<p>Selection of a suitable welding consumable (in some cases of a higher alloy content than the base material)</p> <p>Reduction of the internal welding stresses</p> <p>Proper subsequent treatment of welded seams (e.g. pickling).</p>
<p><i>R RR R</i></p> <p>A critical combination of stress, microstructure and surrounding medium can lead to this form of corrosion. All three of these factors must be present at the same time.</p>	<p>Avoiding stress concentrations.</p> <p>Reducing stress in all welds.</p> <p>Stress-relief annealing</p>

### The occurrence and avoidance of pores

In contrast to the effects described above, the chemical composition of the base material and of the weld metal only have a small effect on the formation of pores during welding. Pores can form in two basic ways.

Gases such as hydrogen, nitrogen and oxygen can be dissolved in liquid steel. In metallurgical pore formation, these gases precipitate as gas bubbles during the solidification process due to the abrupt change in solubility between the liquid and solid phases ( $H_2$ ,  $N_2$ ,  $CO$ ,  $O_2$ ). If the rate of solidification is greater than that with which the gas bubbles rise, they are enclosed („frozen in“), and are left behind, mostly as spherical pores in the welded seam. Depending on the amount of gas found, these pores can also take a tubular form. Gas bubbles arise at the boundary between the liquid and solid phases and in the slag particles floating in the melt.

## 9.3 Instructions for avoiding welding defects

Mechanical pore formation occurs when cracks or cavities filled with gases – such as air – are welded over. If the gases, as they expand under the influence of the welding heat, cannot completely escape in a different direction, a pressure develops which is released through the formation of bubbles in the liquid weld pool. This effect can be reinforced by materials in the cracks and cavities that release gases (moisture, grease and oils, paint residues, metallic coatings). Mechanically formed pores usually have a connection to the hollow spaces that caused them.

faults and causes	counter-measures
<i>R</i>	<i>R</i>
High nitrogen content in the base material and the welding consumable	Use of welding consumables appropriate for the base material, having an increased capacity to dissolve nitrogen (e.g. higher Cr and Mn contents in austenitic alloys)
Nitriding through plasma cutting	Grind the cutting edge
Inadequate screening of the arc region from the atmosphere by: - arc too long - incorrect angle of attack of the electrode - damaged electrode covering - blowing effect	Weld with a short arc Weld with a steep angle of attack Ensure that the electrode covering is undamaged and centralised Ensure a symmetrical contact with the material, weld with AC if possible
Too little shielding gas through: - setting too low - leaking line - capillary hole too small - not enough input pressure to the pressure reducer	Change the setting suitably Look for and remedy leaks Correct association of capillary and pressure reducer The pressure in the bottle and in the line must correspond to the necessary input pressure to the pressure reducer
Inadequate gas shield through: - draughts through open windows, doors etc. - gas quantity too low at the beginning or end of welding - gas nozzle distance too great - wire electrode outlet off-centre - wrong gas nozzle shape - wrong gas nozzle adjustment	Avoid draughts, position the suction unit differently Allow the gas to flow for a longer time before or after welding Reduce the gas nozzle distance Align the wire electrode better, arrange the contact tube centrally Match the gas nozzle shape to the prepared seam Arrange the gas nozzle behind the torch (seen in the welding direction) if possible
Turbulence due to: - shielding gas flow rate too high - spatters on the gas nozzle or contact tube - unsteady arc	Reduce the gas quantity Clean the gas nozzle and the contact tube during welding pauses Clean the gas nozzle, rectify faults in the wire feed, increase the voltage of spluttering wire electrode, ensure good current transfer in the contact tube, proper ground connection, remove slag from previously welded seams

## 9.3 Instructions for avoiding welding defects

faults and causes	counter-measures
<p>Thermal up-current or chimney effect due to:</p> <ul style="list-style-type: none"> <li>- weld pool temperature being too high</li> <li>- workpiece temperature being too high</li> <li>- unimpeded draft in pipelines</li> </ul>	<p>Reduce size of weld pool</p> <p>Reduce preheat or interpass temperature (if possible metallurgically)</p> <p>Seal pipes</p>
<p>Moisture due to:</p> <ul style="list-style-type: none"> <li>- moist electrode coating (increased H contents)</li> <li>- condensation on wire electrode</li> <li>- moisture on base metal</li> <li>- leaking water-cooled torch</li> <li>- condensation on shielding gas nozzle</li> </ul>	<p>Re-dry electrodes according to manufacturer's instructions</p> <p>Equalize temperature of filler metal, store in a dry place</p> <p>Dry weld area by skin-drying or preheating</p> <p>Look for leaks and remedy, dry wire transport hose in case water has got in</p> <p>Check torch cooling for excess capacity</p> <p>Weld over arc strikes</p>
<p>Incorrect handling of basic electrodes</p>	<p>Use basic electrode with higher Mn content</p>
<p>Rounding of segregation zones</p>	<p>Reduce penetration by decreasing the arc power or increasing the welding speed.</p>
<p>Rusty and scaly surfaces</p>	<p>Clean weld area prior to welding</p>
<i>R</i>	
<p>Inclusion of air in the area immediately surrounding the weld</p>	<p>Create opportunities for entrained air to escape e.g. increase welding gap, use butt welds instead of fillet or lap welds</p>
<p>Moisture in welding gap, possibly chemically bonded to rust</p>	<p>Remove moisture by preheating, remove rust or layers of scale, use butt welds instead of fillet or lap welds</p>
<p>Layers of grease in welding gap, present either as contamination or to prevent corrosion or applied intentionally for lubrication purposes</p>	<p>Remove grease using solvents, increase welding gap and dry well, use butt welds instead of fillet or lap welds</p>
<p>Metallic coatings (e.g. tin, zinc)</p>	<p>Comply with recommended layer thicknesses, remove metal coatings if necessary, increase welding gap, use butt welds instead of fillet or lap welds</p>
<p>Coating materials (e.g. production coatings)</p>	<p>Choose favourable coating material, comply with prescribed coating thickness, remove any layers that are too thick if necessary, ensure good degasification in the gap, use butt welds to replace fillet or lap welds</p>

## 10.0 Economic considerations

A wide variety of various criteria must be considered in the design of a component if it is to be manufactured economically. Above all, this means the design of the component appropriately for its function, stress, materials and fabrication. If the component needs to be implemented as a welded construction, other factors, such as the cost of materials, of processing the individual parts, and the welding costs enter into the economic consideration.

Although it is not possible to give general instructions and solutions for the economic design of welded components, nevertheless a number of basic rules can be defined that make the work easier and save costs. Rules of this sort are listed below, but the sequence in which they are given does not necessarily correspond to their significance.

- Dimension fillet welds properly
    - Keep fillet welds as thin as possible
    - Consider the formation of the fillet weld, and exploit deeper fusion penetration
    - Arrange for thin, long fillet welds
    - Provide double fillet welds where possible
  - Consider accessibility
  - Employ economical seam types at butt joints
    - Apply as little weld metal as possible
    - Bear the welding method in mind, e.g. use flux cored wire
    - Check the included angle of the seam
    - Check the effect of the material on the type of seam
    - Consider root back-welding
  - Exploit cost reduction potentials in manufacture
    - Specify allowed times
    - Analyse the times, and look for possible savings
  - Reduce the pure welding time
    - While bearing in mind the base materials, wall thickness and other parameters:
      - Use greater current with the same electrode diameter
      - Use thicker electrodes
      - Use other types of electrode
      - Use other auxiliary welding materials
    - Employ methods with higher capacity, such as welding with flux cored wire or SAW wire
- Select an easier welding position
- Mechanise the manufacture
    - Partial mechanisation of the welding method used
    - Replace the existing method with a mechanised welding method
    - Adapt the joint preparation
  - Use backings aids for economy and calculation

- Do not apply more weld metal than necessary
  - Assemble with dimensional accuracy
  - Make more accurate flame cuts
  - Monitor seam thickness and weld reinforcements
- Reduce downtimes
  - Use igs
- Avoid or reduce distortion
  - Include specifications for distortion, pre-bend
  - Pre-stress
  - Prepare a welding sequence plan
  - Check seam shape and weight
  - Use methods with less distortion
  - Weld from both sides at the same time
- Reduce interruptions and rework associated with the method
  - Shorten interruptions associated with the method
  - Make slag removal easier
  - Reduce spatter by choosing the right electrode type, e.g. use flux cored wire
  - Reduce spatter by choosing the right shielding gas
  - Avoid spatter using the pulsed arc technique under mixed gas
  - Set up a central gas supply
- Reduce malfunctions at devices
  - Use high quality equipment
  - Carry out preventive maintenance
  - Maintain equipment regularly
  - Follow the operating instructions
- Save energy costs
  - Reduce cable losses
  - Switch off devices during pauses
  - Use energy-saving processes
  - Use energy-saving power sources
- Train and motivate welders
- Rectify harmful environmental influences
- Observe costs and quality
- Consider the effect of faults in joint preparation on the quality of the welded seam
  - Design for inspection

voestalpine Böhler Welding Austria GmbH  
Böhler-Welding-St. 1  
8605 Kapfenberg / AUSTRIA  
Phone: +43 (0) 3862-301-0  
Telefax: +43 (0) 3862-301-95193

**voestalpine**

ONE STEP AHEAD.